

**PL** **GTV** to międzynarodowy dystrybutor akcesoriów meblowych i oświetlenia. Jest jedną z najdynamiczniej rozwijających się firm w Polsce. Spółka obecna jest na kilkudziesięciu rynkach w Europie, Azji i Ameryce, a produkty z logo GTV znajdują się w milionach domów i biur na całym świecie. GTV jest firmą w 100% z polskim kapitałem. Spółka dysponuje własnym zapleczem techniczno-logistycznym umożliwiającym swobodne prowadzenie działalności o ogólnosiwiatowym zasięgu. Siedziba firmy to nowoczesne, w pełni z informatyzowane centrum logistyczne w Pruszkowie, w pobliżu autostrady A2. Na jego terenie znajduje się biurowiec oraz dwa magazyny o powierzchni 13 000 m kw. z wydzielonymi składami celnymi, mieszczące 20 000 euro palet. W podwarszawskim Błoniu spółka wynajmuje dodatkowo blisko 5000 m kw. powierzchni magazynowych. Portfolio GTV to jedna z najbardziej kompletnych ofert na rynku. Obejmuje kilka tysięcy produktów, w kilkudziesięciu grupach produktowych, w tym m.in.: zawiasy, prowadnice, podnośniki, uchwyty, wyposażenie garderoby i kuchni oraz oświetlenie LED.

**EN** **GTV** is an international distributor of furniture accessories and LED lighting. GTV has over 20 years of experience in cooperation with the largest furniture manufacturers in the world and millions of customers using the company's products. Today GTV is one of the international leaders in distribution of furniture accessories and LED lighting, present on dozens of markets worldwide. GTV's headquarter is a modern logistics center, located 25 km from the center of the Polish capital, Warsaw. GTV's head office is a four-story office building and two warehouses on an area of 13000 square meters with storage capacity of over 20,000 euro pallets. With its modern infrastructure, the company is able to fulfill orders from all over the world at the time indicated by the customer. GTV implementing its long-term business strategy, actively promotes its products by participating in the world's most prestigious trade fairs e.g. in Russia, Germany, Italy, Poland, Brazil. Professional service, competent team of specialists and transparent procedures allow us to effectively meet the needs of business partners.

**RU** **GTV** – это международный дистрибьютор мебельной фурнитуры и освещения. Мы работаем в десятках стран Европы, Азии и Америки, а продукция с логотипом GTV известна во всем мире. GTV – это современный, полностью информатизированный логистический центр возле Варшавы. На его территории находится офисное здание и два склада площадью 13 000 м2 с отдельными таможенными складами вместимостью 20 000 европаллет. Дополнительно фирма располагает складскими помещениями площадью почти 5000 квадратных метров. Ассортимент компании GTV включает несколько тысяч наименований продукции: петли, направляющие, подъемники, ручки, оснащение для гардероба и кухни, светодиодное освещение.





# GTV

FURNITURE  
ACCESSORIES

- PL** GTV Akcesoria Meblowe, marka obecna na rynku od ponad dwudziestu lat to niekwestionowany lider dostarczający najbardziej kompletne portfolio akcesoriów dla branży meblarskiej. Dzięki przemyślanej strategii rozwoju, marka oferuje nieosiągalną dla innych firm relację ceny do jakości, dostarczając funkcjonalne oraz zaprojektowane zgodnie z najnowszymi trendami produkty w przystępnych cenach.
- EN** GTV furniture accessories brand is present on the market for over 20 years, building its position as one of the international leaders. The company is present in Europe, Asia and America, whereas products with the GTV logo are to be found in millions of households and offices worldwide. Thanks to carefully planned strategy and logistics, GTV can offer products with an unreachable for other companies price to quality ratio.
- RU** Мебельная фурнитура с логотипом GTV известна на рынке уже более двадцати лет, а портфолио компании является одним из наиболее полных предложений на мебельном рынке. Благодаря продуманной стратегии развития, эффективному управлению и открытости к новым идеям, компания GTV быстро стала лидером в дистрибуции мебельной фурнитуры. Секрет успеха компании заключается в предоставлении продукции высокого качества по приемлемой цене.



# GTV

SLIDING DOOR  
SYSTEMS

- PL** GTV Systemy Przesuwne, to marka która powstała w 2014 r. z myślą o profesjonalistach poszukujących rozwiązań ułatwiających i przyspieszających montaż drzwi przesuwnych. Systemy przesuwne zostały zaprojektowane przez naszych konstruktorów, dla których inspiracją były opinie polskich stolarzy. Dzięki tej owocnej współpracy powstał produkt, który nie tylko przekonuje praktycznymi, konstrukcyjnymi ulepszeniami. Są to również szczegóły decydujące o przewadze produktu jak unikatowy materiał, z którego wykonane zostały kółka w systemach jezdnych.
- EN** GTV Sliding Door Systems is a brand developed in 2014, for professionals seeking reliability and highest quality. Our systems have been created to meet the needs, of the most demanding customers. The idea behind the systems was inspired by carpenters, who tend to look for solutions, that will make their work more effective. GTV Sliding Door Systems offer not only practical constructional improvements. But also highest quality of components. The whole system is based on reliable elements, especially rollers thanks to which this system stands out of the competition. All of the functional accessories have been carefully selected and underwent thorough strict quality control.
- RU** Раздвижные системы GTV - бренд, созданный в 2014 году с мыслью о профессионалах, ищущих новые возможности, позволяющие ускорить процесс установки раздвижных дверей. Раздвижные системы GTV были спроектированы по инициативе производителей мебели и являются авторской разработкой инженеров компании GTV. В результате плодотворной работы был создан продукт, интересный не только своими техническими решениями, но и отличающийся качеством используемого материала в нижних ходовых элементах.

# GTV

LIGHTING

- PL** Marka GTV Lighting została wprowadzona na rynek 2007 r. oferując rozwiązania oświetleniowe przeznaczone do biur, budynków przemysłowych, magazynowych i użyteczności publicznej opartych na technologii LED. Portfolio zawiera również produkty LED dla klientów indywidualnych – źródła LED, oświetlenie meblowe. GTV Lighting to szeroka i kompletna oferta, elastyczność w podejściu do partnerów biznesowych a także serwis.
- EN** The GTV Lighting brand was launched in 2007, it has been created, to provide professional lighting solutions for offices, industrial buildings and warehouses - based on LED technology. The portfolio also includes LED solutions for private consumers - home and garden lighting, furniture lighting. GTV Lighting offers also a wide and complete portfolio of services, such as lighting planning consulting.
- RU** Товарная группа GTV освещение появилась в ассортименте компании в 2007 году и представляет собой подборку интересных световых решений для офисов, промышленных зданий, складских помещений, общественных зданий, а также решений подходящих индивидуальным клиентам — источники светодиодного освещения и освещение для мебели. GTV освещение предлагает широкий спектр продукции и гибкость в подходе к бизнес-партнёрам и услугам, которые мы предоставляем.

## **AKCESORIA FUNKCYJNE FUNCTIONAL ACCESSORIES ФУНКЦИОНАЛЬНАЯ ФУРНИТУРА**

Zawiasy Hinges Петли	8 – 36
Amortyzatory Buffers Амортизаторы	37 – 42
Podnośniki Lifts Подъёмники	43 – 53
Prowadnice Slides Направляющие	54 – 84
Systemy szuflad Drawer systems Выдвижные ящики	85 – 119
Elementy łączeniowe Brackets and fittings Соединительные элементы	120 – 150
Listwy Work top strip Планки для столешниц	151 – 158
Mocowania do rur Rails accessories and fittings Крепление для труб	159 – 180
Wyposażenie garderoby Wardrobe accessories Наполнение для шкафов-купе	181 – 196
Aksesoria kuchenne Kitchen accessories Кухонные аксессуары	197 – 225
Aksesoria biurowe Office accessories Аксессуары для офиса	226 – 231
Inne Other Другие	232 – 235

## **AKCESORIA DEKORACYJNE DECORATIVE ACCESSORIES ЛИЦЕВАЯ ФУРНИТУРА**

Uchwyty Handles Ручки	238 – 319
Wieszaki Hooks Крючки	320 – 332

Nóżki meblowe Furniture legs Мебельные ножки	333 – 360
Nogi meblowe Furniture legs Мебельные опоры	361 – 366
Rolki meblowe Furniture castors Мебельные ролики	367 – 371
Zamki meblowe Cabinet locks Замки	372 – 379

## **SYSTEMY PRZESUWNE SLIDING DOOR SYSTEMS РАЗДВИЖНЫЕ СИСТЕМЫ**

Dolny układ jezdny Bottom-running systems Нижняя ходовая система	382 – 406
Górny układ jezdny Top-running systems Верхняя ходовая система	407 – 411

## **OŚWIETLENIE MEBLOWE FURNITURE LIGHTING МЕБЕЛЬНОЕ ОСВЕЩЕНИЕ**

Taśmy led Furniture lighting Светодиодные ленты	414 – 415
Profile LED LED profiles Профили LED	416 – 433
Oprawy led Led strips Светодиодные светильники	434 – 452
Oprawy halogenowe Led fixtures Галогенные светильники	453 – 454
Akcesoria Accessories Аксессуары	455 – 472
Przedłużacze biurkowe Electrical installation equipment Выдвижные розетки	473 – 479

**AKCESORIA FUNKCYJNE  
FUNCTIONAL ACCESSORIES  
ФУНКЦИОНАЛЬНАЯ ФУРНИТУРА**

Zawiasy Hinges Петли	8 – 36
Amortyzatory Buffers Амортизаторы	37 – 42
Podnośniki Lifts Подъемники	43 – 53
Prowadnice Slides Направляющие	54 – 84
Systemy szuflad Drawer systems Выдвижные ящики	85 – 119
Elementy łączeniowe Brackets and fittings Соединительные элементы	120 – 150
Listwy Work top strip Планки для столешниц	151 – 158
Mocowania do rur Rails accessories and fittings Крепление для труб	159 – 180
Wyposażenie garderoby Wardrobe accessories Наполнение для шкафов-купе	181 – 196
Akcesoria kuchenne Kitchen accessories Кухонные аксессуары	197 – 225
Akcesoria biurowe Office accessories Аксессуары для офиса	226 – 231
Inne Other Другие	232 – 235

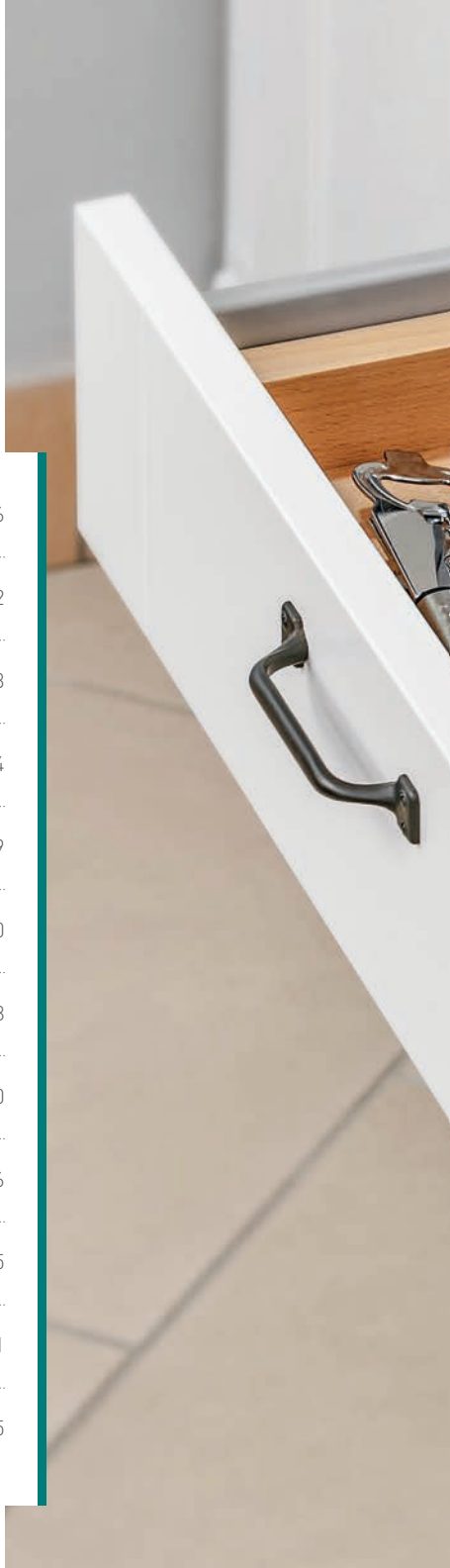



**MB**

KITCHEN BOX

## Orientacyjna ilość zawiasów puszkowych Ø35\*

\* nie dotyczy modeli specjalnych o szerokim kącie otwarcia

## Approximate amount of hinges Ø35\*

\* not applicable for special hinges with wide opening angle

## Приблизительное количество шарнирных петель Ø35\*

\*не касается специальных моделей с широким углом открывания

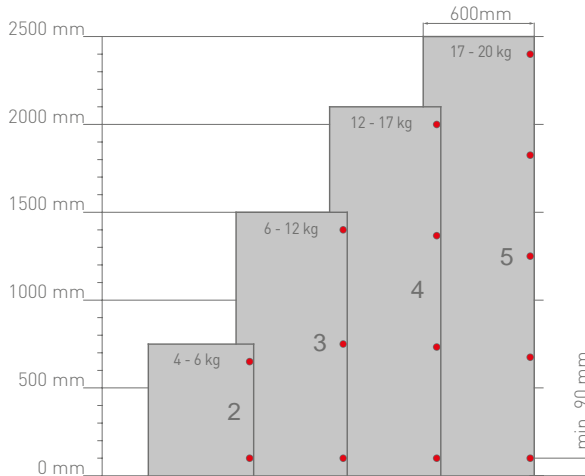

## Orientacyjna ilość zawiasów puszkowych Ø26 oraz Ø35\*

\* dotyczy modeli specjalnych o szerokim kącie otwarcia

## Approximate amount of hinges Ø26 and Ø35

\* not applicable for special hinges with wide opening angle

## Приблизительное количество шарнирных петель Ø26 и Ø35\*

\*касается специальных моделей с широким углом открывания

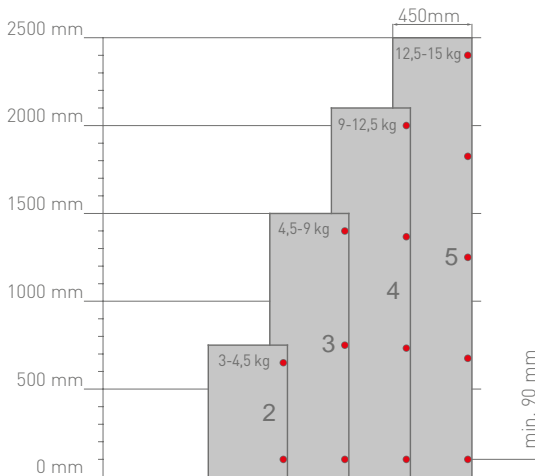

- Ilość użytych zawiasów jest zależna od wysokości, szerokości i ciężaru frontu.
- W celu zapewnienia stabilności, odległość między zawiasami powinna być jak największa.
- Przed przystąpieniem do seryjnej produkcji należy przeprowadzić próbę montażu i sprawdzić poprawność funkcjonowania.
- To ensure stability, the distance between the hinges should be as big as possible.
- Number of hinges that should be used, depends on the height, width and weight of the front.
- Before starting mass production, mounting tests should be performed in order to ensure proper functioning.



Zawias hydrauliczny ECHC, nakładany  
 Hydraulic cup hinge ECHC, overlay door  
 Гидравлическая петля ECHC, накладная

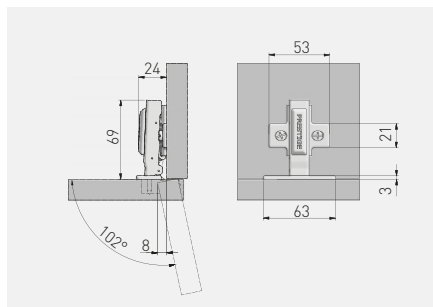

ZM-ECHC09BEO	H=0	x 4	—	nikiel nickel нικель	stal steel сталь
ZM-ECHC09ZEO		x 2	x 2		



Zawias hydrauliczny ECHC, bliźniaczy  
 Hydraulic cup hinge ECHC, twin overlay door  
 Гидравлическая петля ECHC, полунакладная

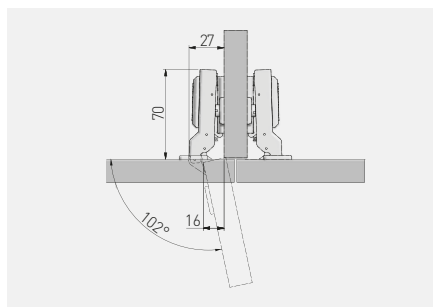

ZM-ECHC08BEO	H=0	x 4	—	nikiel nickel нικель	stal steel сталь
ZM-ECHC08ZEO		x 2	x 2		



Zawias hydrauliczny ECHC, wpuszczany  
 Hydraulic cup hinge ECHC, inset door  
 Гидравлическая петля ECHC, внутренняя

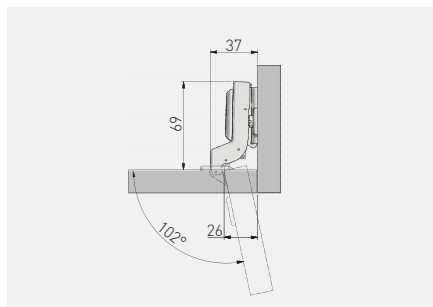

ZM-ECHC07BEO	H=0	x 4	—	nikiel	stal
ZM-ECHC07ZEO		x 2	x 2	nickel никель	steel сталь



Zawias hydrauliczny ECHC-3D, nakładany  
 Hydraulic cup hinge ECHC-3D, overlay door  
 Гидравлическая петля ECHC-3D, накладная

NEW

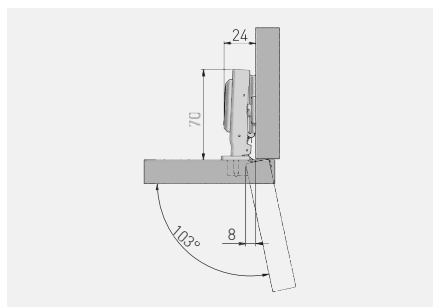

ZM-ECHC09-3DBEO	H=0	x 4	—	nikiel	stal
				nickel	steel
				никель	сталь



Zawias hydrauliczny ECHC-3D, bliźniaczy  
Hydraulic cup hinge ECHC-3D, twin overlay door  
Гидравлическая петля ECHC-3D, полунакладная

NEW

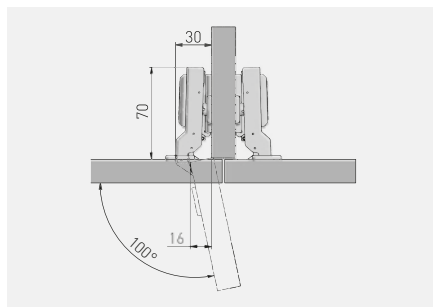

ZM-ECHC08-3DBE0	H=0	x 4	—	nikiel nickel нικель	stal steel сталь



Zawias hydrauliczny ECHC-3D, wpuszczany  
Hydraulic cup hinge ECHC-3D, inset door  
Гидравлическая петля ECHC-3D, внутренняя

NEW

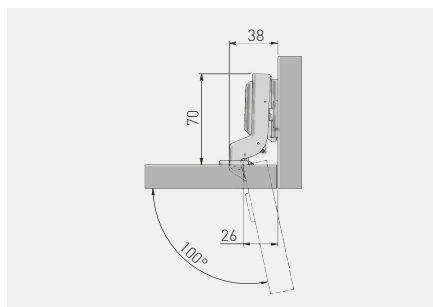

ZM-ECHC07-3DBE0	H=0	x 4	—	nikiel nickel нικель	stal steel сталь



Zawias hydrauliczny CNHC, nakładany  
 Hydraulic cup hinge CNHC, overlay door  
 Гидравлическая петля CNHC, накладная

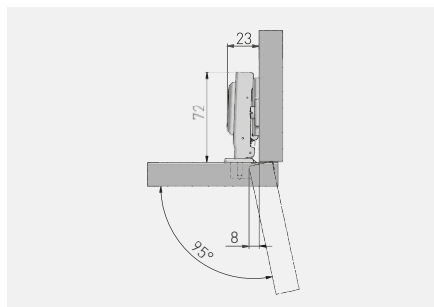

ZM-CNHC09BR2	H=0	x2	x 2	nikiel nickel нικель	stal steel сталь



Zawias hydrauliczny CNHC, bliźniaczy  
 Hydraulic cup hinge CNHC, twin overlay door  
 Гидравлическая петля CNHC, полунакладная

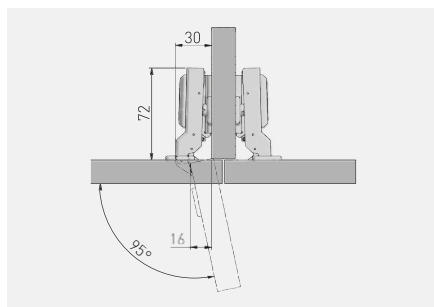

ZM-CNHC08BR2	H=0	x 2	x 2	nikiel nickel нικель	stal steel сталь



Zawias hydrauliczny CNHC, wpuszczany  
 Hydraulic cup hinge CNHC, inset door  
 Гидравлическая петля CNHC, внутренняя

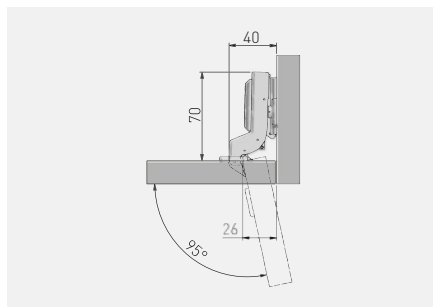

ZM-CNHC07BR2	H=0	x 2	x 2	nikiel nickel нικель	stal steel сталь



Zawias hydrauliczny INHC, nakładany  
 Hydraulic cup hinge INHC, overlay door  
 Гидравлическая петля INHC, накладная

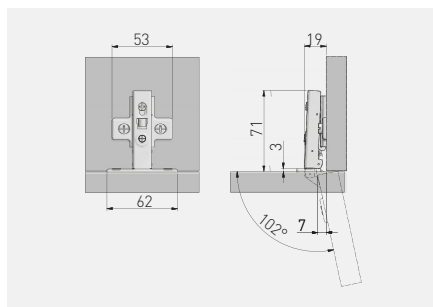

ZM-INHC090BEO	H=0	—	—	nikiel nickel нικель	stal steel сталь
ZM-INHC090ZEO		—	x 2		



Zawias hydrauliczny INHC, bliźniaczy  
 Hydraulic cup hinge INHC, twin overlay door  
 Гидравлическая петля INHC, полунакладная

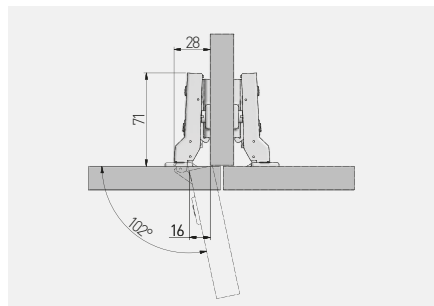

ZM-INHC080BEO	H=0	—	—	nikiel nickel	stal steel
ZM-INHC080ZEO		—	x 2	никель nickel	сталь steel



Zawias hydrauliczny INHC, wpuszczany  
 Hydraulic cup hinge INHC, inset door  
 Гидравлическая петля INHC, внутренняя

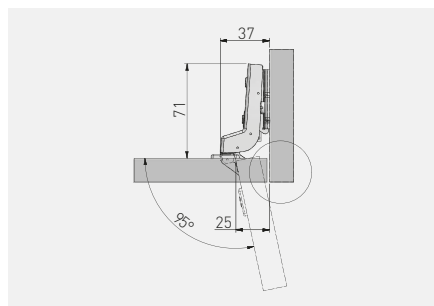

ZM-INHC070BEO	H=0	—	—	nikiel nickel	stal steel
ZM-INHC070ZEO		—	x 2	никель nickel	сталь steel





Zawias kątowy 30°, hydrauliczny HCKT  
 Hydraulic corner cup hinge 30° HCKT  
 Угловая петля 30°, гидравлическая HCKT

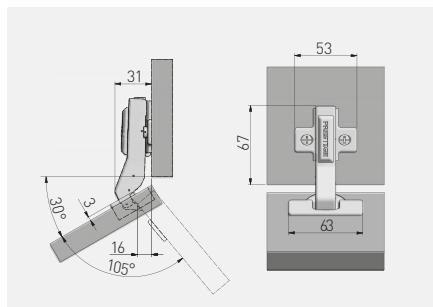

ZM-HCKT30-BE	H=0	x 4	—	nikiel nickel никель	stal, ZnAl steel, ZnAl сталь, ZnAl
ZM-HCKT30-ZE		x 2	x 2		



Zawias kątowy 45° hydrauliczny HCKT  
 Hydraulic corner cup hinge 45° HCKT  
 Угловая петля 45°, гидравлическая HCKT

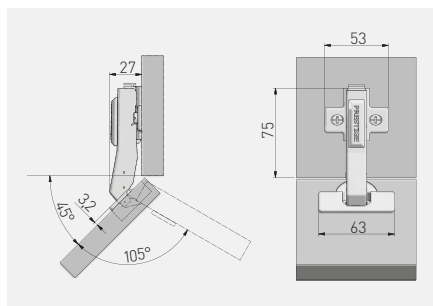

ZM-HCKT45-BE	H=0	x 4	—	nikiel nickel никель	stal, ZnAl steel, ZnAl сталь, ZnAl
ZM-HCKT45-ZE		x 2	x 2		



Zawias równoległy hydrauliczny HCKT  
 Parallel hydraulic hinge HCKT  
 Гидравлическая петля под фальшпанель HCKT

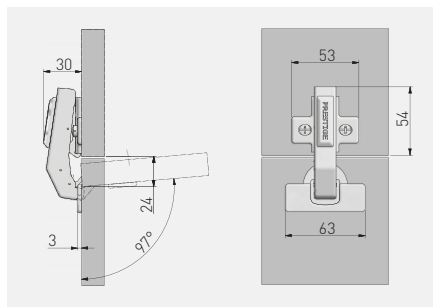

ZM-HCKT90-BE	H=0	x 4	—	nikiel nickel никель	stal, ZnAl steel, ZnAl сталь, ZnAl
ZM-HCKT90-ZE		x 2	x 2		



Zawias z ujemnym uskokiem 155° hydrauliczny HCKT  
 Hydraulic set-off hinge 155° HCKT  
 Гидравлическая петля 155° HCKT

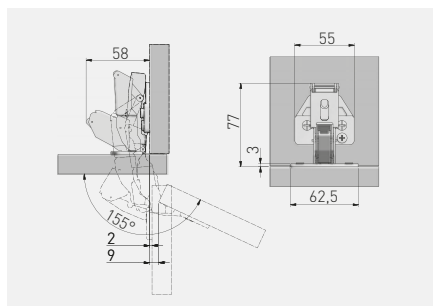

ZM-HCKT155BE	H=0	—	—	nikiel nickel никель	stal steel сталь
ZM-HCKT155ZE		—	x 2		



Zawias 165° hydrauliczny HCKT  
 Hydraulic hinge 165° HCKT  
 Гидравлическая петля 165° HCKT

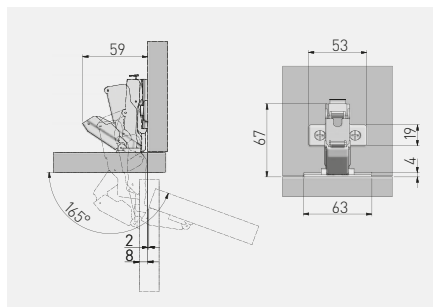

ZM-HCKT165BE	H=0	—	—	nikiel nickel никель	stal, ZnAl steel, ZnAl сталь, ZnAl
ZM-HCKT165ZE		—	x 2		



Zawias CONL, nakładany  
 Hinge CONL, overlay door  
 Петля CONL, накладная

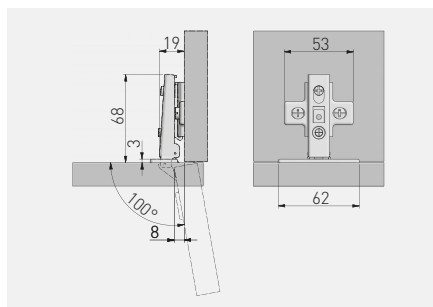

ZP-CONL09-BE	H=0	—	—	nikiel nickel никель	stal steel сталь
ZP-CONL09-ZE		—	x 2		



Zawias CONL, bliźniaczy  
Hinge CONL, twin overlay door  
Петля CONL, полунакладная

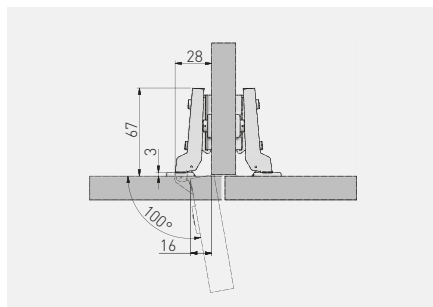

ZP-CONL08-BE	H=0	—	—	nikiel nickel	stal steel
ZP-CONL08-ZE		—	x 2	никель nickel	сталь steel



Zawias CONL, wpuszczany  
Hinge CONL, inset door  
Петля CONL, внутренняя

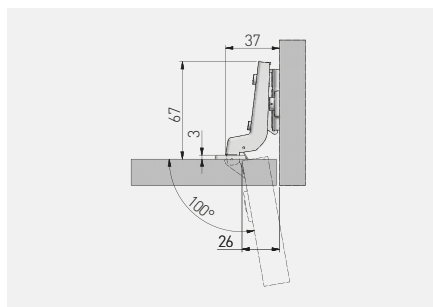

ZP-CONL07-BE	H=0	—	—	nikiel nickel	stal steel
ZP-CONL07-ZE		—	x 2	никель nickel	сталь steel



Zawias BICN, nakładany  
Hinge BICN, overlay door  
Петля BICN, накладная

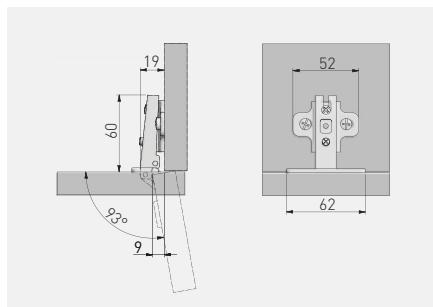

ZP-BICN090BEO	H=0	—	—	nikiel nickel никель	stal steel сталь	
ZP-BICN090ZEO		—	x 2			
ZP-BICN092BEO	H=2	—	—	nikiel nickel никель	stal steel сталь	
ZP-BICN092ZEO		—	x 2			



Zawias BICN, bliźniaczy  
Hinge BICN, twin overlay door  
Петля BICN, полунакладная

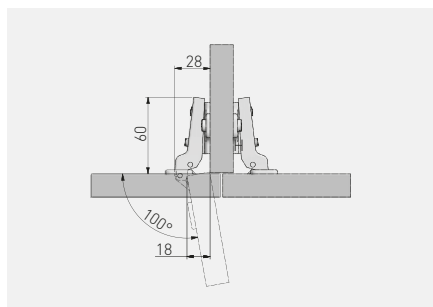

ZP-BICN080BEO	H=0	—	—	nikiel nickel никель	stal steel сталь	
ZP-BICN080ZEO		—	x 2			
ZP-BICN082BEO	H=2	—	—	nikiel nickel никель	stal steel сталь	
ZP-BICN082ZEO		—	x 2			



Zawias BICN, wpuszczany  
Hinge BICN, inset door  
Петля BICN, внутренняя

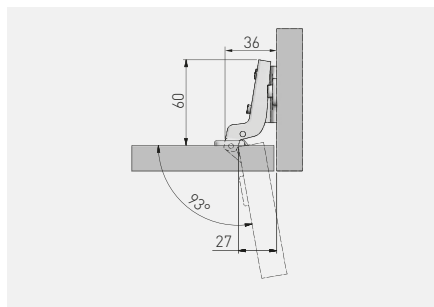

ZP-BICN070BEO	H=0	—	—	nikiel nickel никель	stal steel сталь	
ZP-BICN070ZEO		—	x 2			
ZP-BICN072BEO	H=2	—	—	nikiel nickel никель	stal steel сталь	
ZP-BICN072ZEO		—	x 2			



Zawias kątowy 30° KT  
Corner hinge 30° KT  
Угловая петля 30° KT

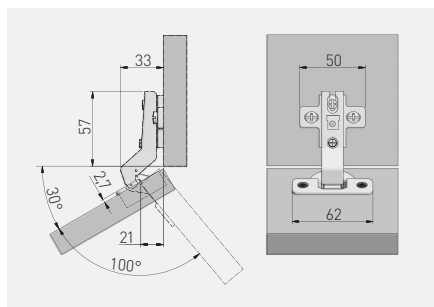

ZP-KT30H2-BE	H=2	—	—	nikiel nickel никель	stal steel сталь	
ZP-KT30H2-ZE		—	x 2			





Zawias kątowy 45° KT  
 Corner hinge 45° KT  
 Угловая петля 45° KT

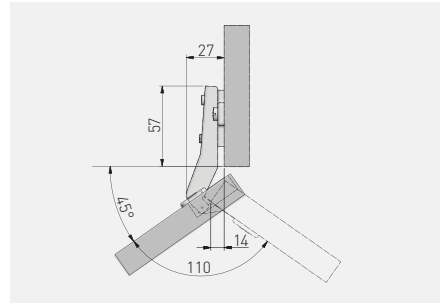

ZP-KT45H2-BE	H=2	—	—	nikiel nickel	stal steel
ZP-KT45H2-ZE		—	x 2	никель	сталь



Zawias równoległy KT  
 Parallel hinge KT  
 Петля под фальшпанель KT

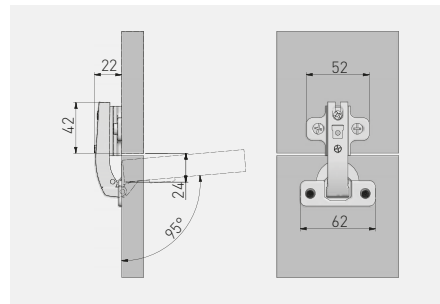

ZP-KT90H2-BE	H=2	—	—	nikiel nickel	stal steel
ZP-KT90H2-ZE		—	x 2	никель	сталь



Zawias równoległy – krótkie ramię KTK  
 Parallel hinge – short arm KTK  
 Петля под фальшпанель с коротким плечем KTK

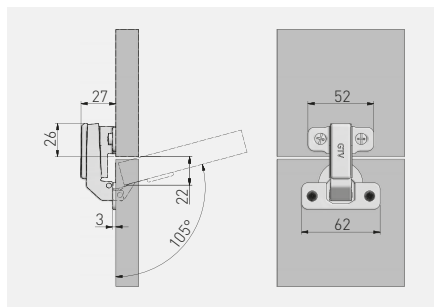

ZP-KTK90H6BE	H=6	—	—	nikiel nickel никель	stal steel сталь
ZP-KTK90H6ZE		—	x 2		



Zawias równoległy nakładany – krótkie ramię KTKN  
 Parallel hinge for overlay door – short arm KTKN  
 Петля под фальшпанель с коротким плечем, накладная KTKN

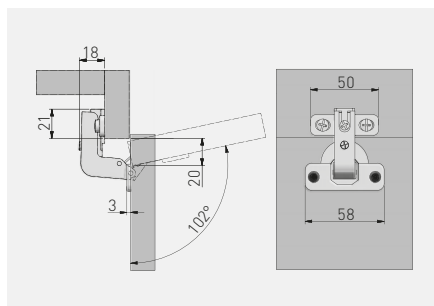

ZP-KTKN90H0	H=0	—	x 2	nikiel nickel никель	stal, ZnAl steel, ZnAl сталь, ZnAl



Zawias 165° KT  
Hinge 165° KT  
Петля 165° KT

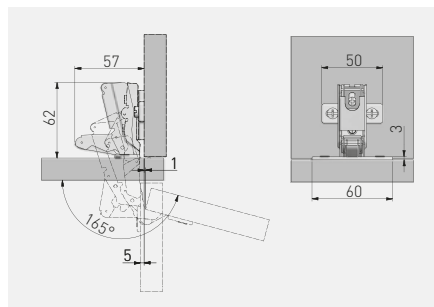

ZP-KT165H2BE	H=2	—	—	nikiel nickel никель	stal steel сталь
ZP-KT165H2ZE		—	x 2		



Zawias 135° KT  
Complementary hinge 135° KT  
Петля для складных дверей 135° KT

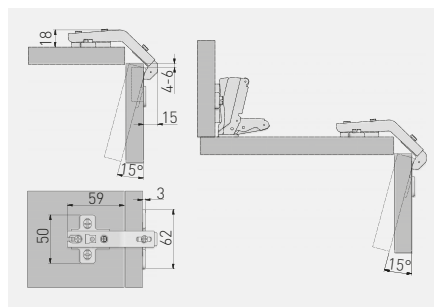

ZP-KT135H2-BE	H=2	—	—	nikiel nickel никель	stal, ZnAl steel, ZnAl сталь, ZnAl
ZP-KT135H2-ZE		—	x 2		



Zawias bez sprężyny COCA, nakładany  
 Hinge without spring COCA, overlay door  
 Петля без пружины СОСА, накладная

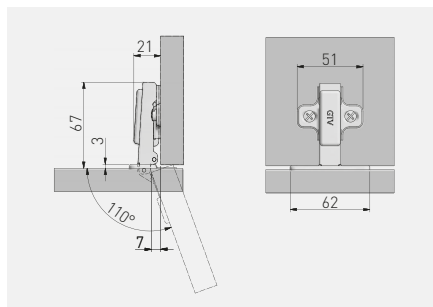

ZP-COCA450-BE	H=0	—	—	nikiel nickel никель	stal steel сталь
ZP-COCA450-ZE		—	x 2		



Zawias bez sprężyny COCA, wpuszczany  
 Hinge without spring COCA, inset door  
 Петля без пружины СОСА, внутренняя

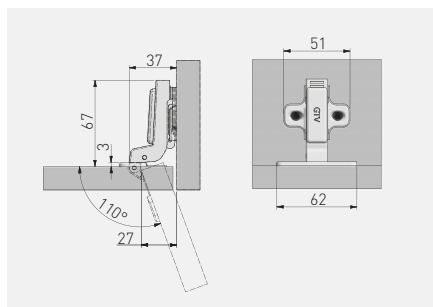

ZP-COCA7450-BE	H=0	—	—	nikiel nickel никель	stal steel сталь



Zawias samootwierający PO, nakładany  
 Self-opening hinge PO, overlay door  
 Петля самооткрывающаяся PO, накладная

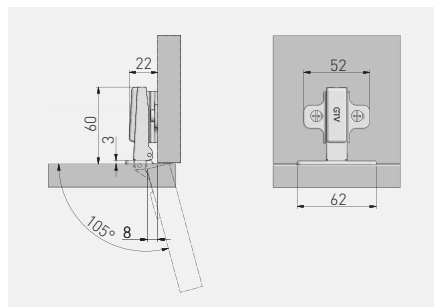

ZP-POH045BEO	H=0	—	—	nikiel nickel никель	stal steel сталь
ZP-POH045ZEO		—	x 2		



Zawias samootwierający PO, wpuszczany  
 Self-opening hinge PO, inset door  
 Петля самооткрывающаяся PO, внутренняя

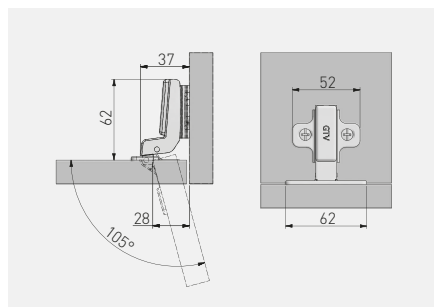

ZP-PO7H045BE	H=0	—	—	nikiel nickel никель	stal steel сталь

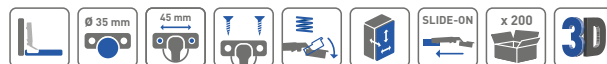

Zawias hydrauliczny mini CIHC, nakładany  
 Hydraulic hinge mini CIHC, overlay door  
 Гидравлическая петля мини CIHC, накладная

NEW

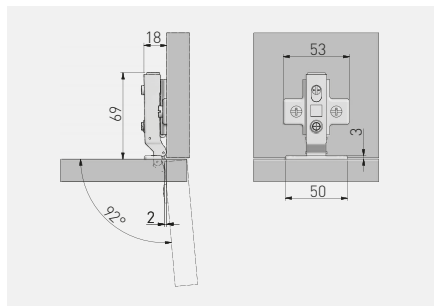

ZP-CIHC090ZE	H=0	x 2	x 2	nikiel nickel никель	stal, ZnAl / steel, ZnAl / сталь, ZnAl
ZM-CIHC09ZE					stal / steel / сталь



Zawias hydrauliczny mini CIHC, bliźniaczy  
 Hydraulic hinge mini CIHC, twin overlay door  
 Гидравлическая петля мини CIHC, полунакладная

NEW

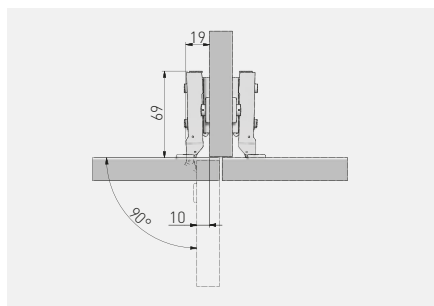

ZP-CIHC080ZE	H=0	x 2	x 2	nikiel nickel никель	stal, ZnAl / steel, ZnAl / сталь, ZnAl
ZM-CIHC08ZE					stal / steel / сталь





Zawias hydrauliczny mini CIHC, wpuszczany  
 Hydraulic hinge mini CIHC, inset door  
 Гидравлическая петля мини CIHC, внутренняя

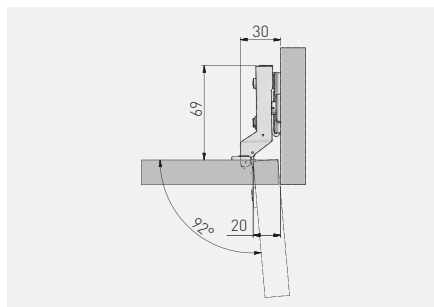

ZP-CIHC070ZE	H=0	x 2	x 2	nikiel nickel никель	stal, ZnAl / steel, ZnAl / сталь, ZnAl
ZM-CIHC07ZE					stal / steel / сталь



Zawias mini CIBI, nakładany  
 Hinge mini CIBI, overlay door  
 Петля мини CIBI, накладная

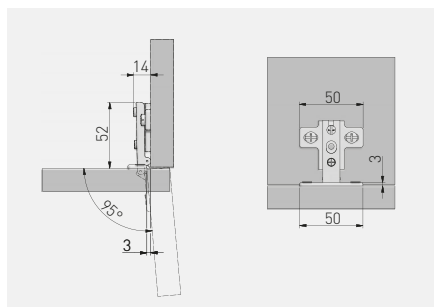

ZP-CIBI9H0ZE	H=0	-	x 2	nikiel nickel никель	stal steel сталь



Zawias mini CIBI, bliźniaczy  
Hinge mini CIBI, twin overlay door  
Петля мини CIBI, полунакладная

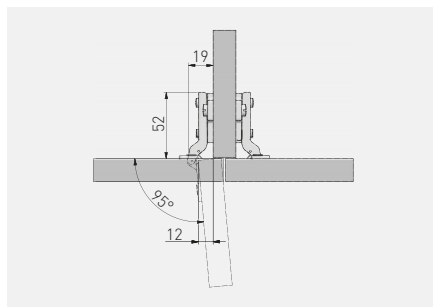

ZP-CIBI8HOZE	H=0	-	x 2	nikiel nickel никель	stal steel сталь



Zawias mini CIBI, wpuszczany  
Hinge mini CIBI, inset door  
Петля мини CIBI, внутренняя

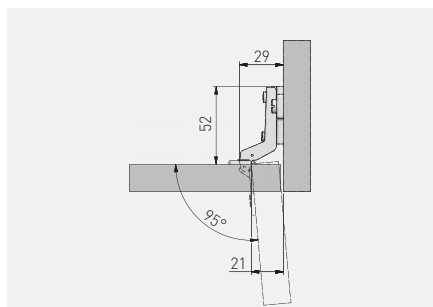

ZP-CIBI7HOZE	H=0	-	x 2	nikiel nickel никель	stal steel сталь



Zawias równoległy mini CI90  
 Parallel hinge mini CI90  
 Петля мини под фальшпанель CI90

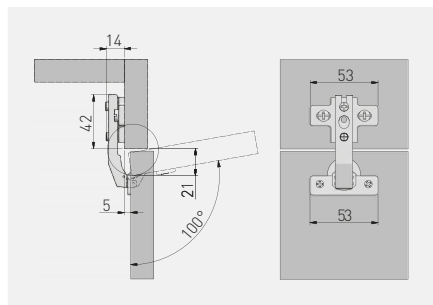

ZP-CI90H2-ZE	H=2	x 2	x 2	nikiel nickel никель	stal steel сталь



Zawias do szkła CIG, nakładany  
Hinge for glass CIG, overlay door  
Петля для стеклянных дверей CIG, накладная

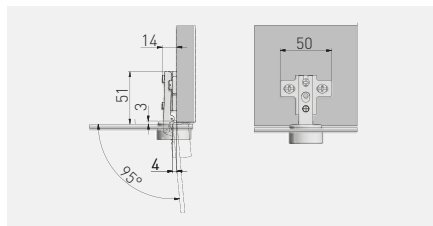

ZP-CIG-090ZE	H=0	—	x 2	nikiel nickel нیکель	stal, tworzywo steel, plastic сталь, пластмасса		chrom / chrome / хром	
ZP-CIG-090ZE		—	x 2					
ZP-CIG-090UBE		—	—					
ZP-CIG-090ZC		—	x 2				czarny / black / чёрный	
ZP-CIG-190ZE		—	x 2				aluminium aluminium алюминий	
ZP-CIG-190ZE		—	x 2					



Zawias do szkła CIG, wpuszczany  
Hinge for glass CIG, inset door  
Петля для стеклянных дверей CIG, внутренняя

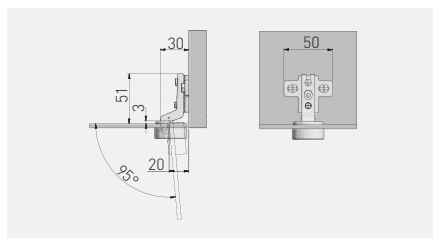

ZP-CIG-070ZE	H=0	—	x 2	nikiel nickel нیکель	stal, tworzywo steel, plastic сталь, пластмасса		chrom chrome хром	
ZP-CIG-070ZE		—	x 2					
ZP-CIG-170ZE		—	x 2				aluminium aluminium алюминий	
ZP-CIG-170ZE		—	x 2					



Zawias do ramek aluminiowych, nakładany

Hinge for aluminium frames, clip-on

Петля GTV для алюминиевых рамок, с клипом, накладная

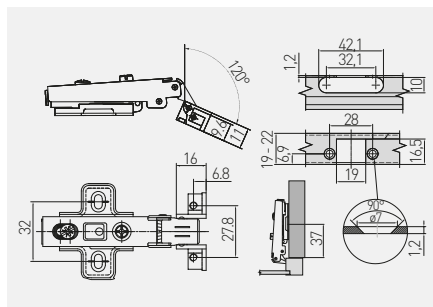
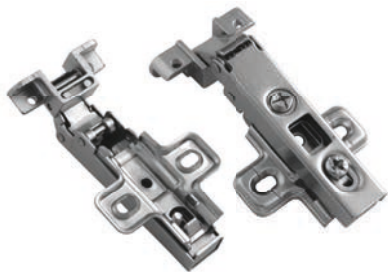

Produkt kompatybilny: profil aluminiowy do frontów: PA-3731-35-50  
 Product compatible with aluminum profile for fronts: PA-3731-35-50  
 Подходит для алюминиевых профилей под индексом: PA-3731-35-50

ZP-RALUH2-00	H=2	—	—	nikiel nickel plated никель	stal steel сталь



Zawias do ramek aluminiowych, bliźniaczy

Hinge for aluminium frames, twin overlay door

Петля GTV для алюминиевых рамок, с клипом, полунакладная

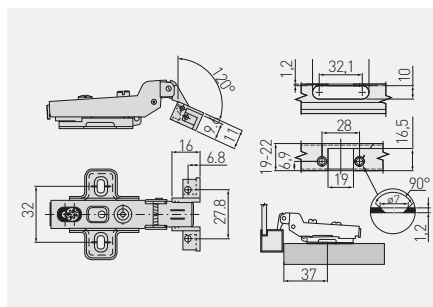

Produkt kompatybilny: profil aluminiowy do frontów: PA-3731-35-50  
 Product compatible with aluminum profile for fronts: PA-3731-35-50  
 Подходит для алюминиевых профилей под индексом: PA-3731-35-50

ZP-RALUH2-08	H=2	—	—	nikiel nickel plated никель	stal steel сталь



Zawias do ramek aluminiowych, wpuszczany

Hinge for aluminium frames, inset door

Петля GTV для алюминиевых рамок, с клипом, внутренняя

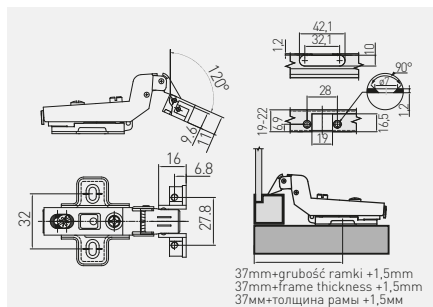

Produkt kompatybilny: profil aluminiowy do frontów: PA-3731-35-50  
 Product compatible with aluminum profile for fronts: PA-3731-35-50  
 Подходит для алюминиевых профилей под индексом: PA-3731-35-50

ZP-RALUH2-07	H=2	—	—	nikiel nickel plated никель	stal steel сталь



Zawias hydrauliczny do ramek aluminiowych, nakładany

Hinge for aluminium frame, overlay door

Петля GTV для алюминиевых рамок, с клипом, накладная

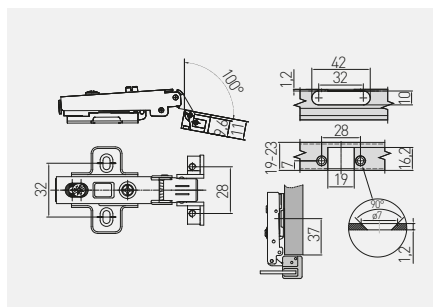

Produkt kompatybilny: profil aluminiowy do frontów: PA-3731-35-50  
 Product compatible with aluminum profile for fronts: PA-3731-35-50  
 Подходит для алюминиевых профилей под индексом: PA-3731-35-50

ZM-HCRALU9BE	H=0	—	—	nikiel nickel plated никель	stal steel сталь



Zawias 270°, nakładany  
Hinge 270°, overlay door  
Петля 270°, накладная

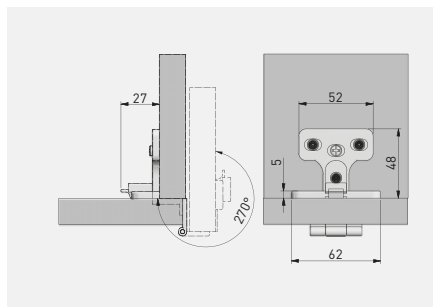

ZP-KT0270-BE	—	—	nikiel nickel никель	ZnAl



Zawias 270°, wpuszczany  
Hinge 270°, inset door  
Петля 270°, внутренняя

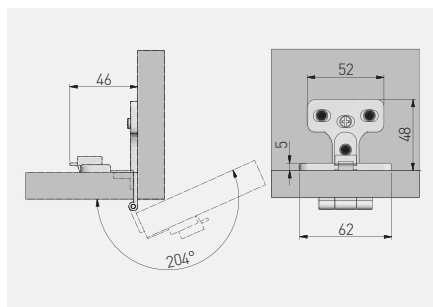





ZP-KT7270-BE	—	—	nikiel nickel никель	ZnAl

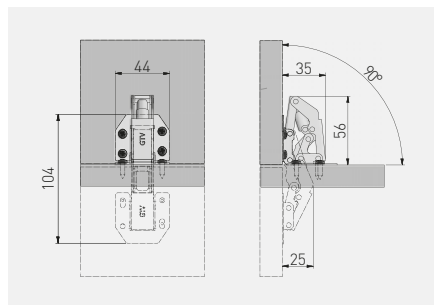

Zawias tłoczkowy duży  
 Cylinder hinge  
 Поршневая петля (большая)







				
ZT-HF-01-D00	—	—	nikiel nickel никель	stal steel сталь

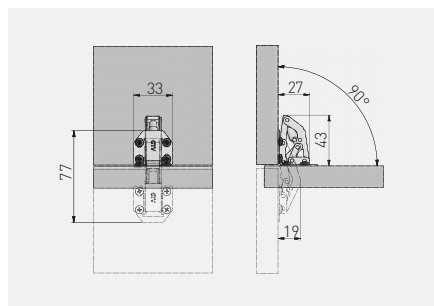

Zawias tłoczkowy mały  
 Cylinder hinge  
 Поршневая петля (малая)



				
ZT-HF-01-M00	—	—	nikiel nickel никель	stal steel сталь





Zawias JUNIOR 75°  
 JUNIOR hinge 75°  
 Петля JUNIOR 75°

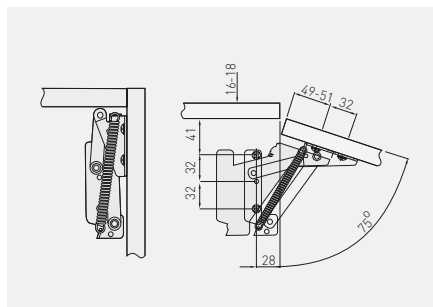

ZP-JUNIOR-00	—	—	nikiel nickel никель	stal steel сталь



Zawias skrzydełkowy  
 Butterfly hinge  
 Петля-бабочка

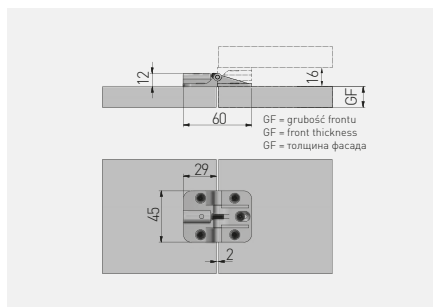





ZP-SKR-00-80	—	—	lakier lacquer лак	szary gray серый	ZnAl

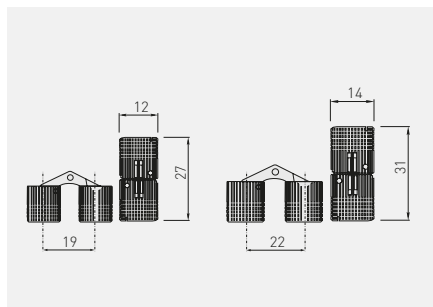

Zawias cylindryczny  
Cylinder hinge  
Петля цилиндрическая





				
ZC-GTV-12-00	12	7	mosiądz brass латунь	mosiądz brass латунь
ZC-GTV-14-00	14			

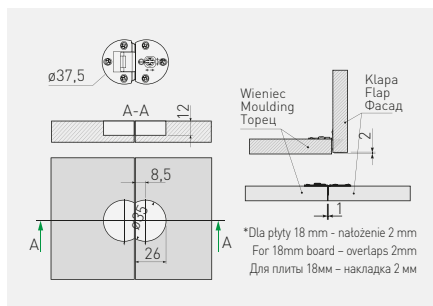
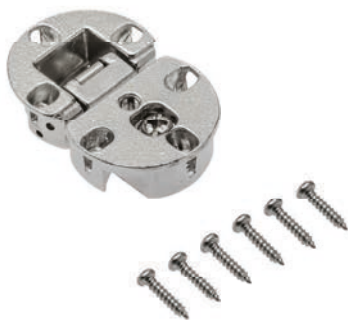

Zawias barkowy  
Flap hinge  
Барная петля



		
PD-MD-ZB-01	chrom / chrome / хром	ZnAl
PD-MD-ZB-04	antyczny mosiądz / antique brass / античная латунь	



Amortyzator regulowany z adapterem prostym  
Adjustable buffer with straight adapter  
Амортизатор регулируемый с прямым адаптером

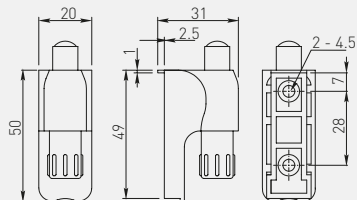

AM-BOCZ01-60

szary  
gray  
серыйtworzywo  
plastic  
пластмасса

Amortyzator z adapterem prostym  
Buffer with straight adapter  
Амортизатор с прямым адаптером

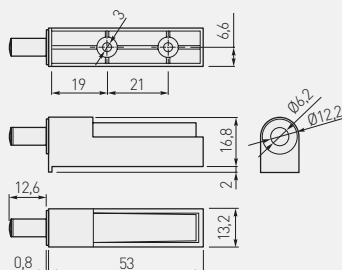

AM-PROST-KPL

szary  
gray  
серыйtworzywo  
plastic  
пластмасса

Amortyzator z adapterem krzyżakowym  
 Buffer with cross adapter  
 Амортизатор с крестовым адаптером

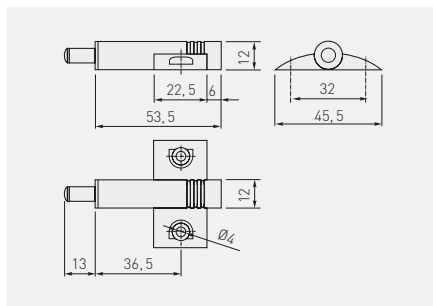

AM-KRZYZ-KPL

szary  
gray  
серый

tworzywo  
plastic  
пластмасса



Amortyzator AM-ODB  
 Buffer AM-ODB  
 Амортизатор AM-ODB

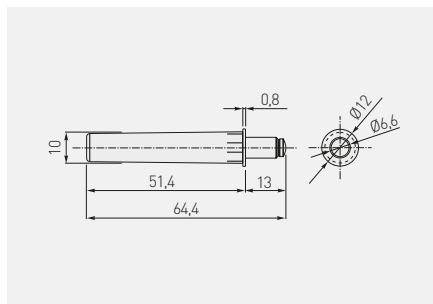

AM-ODB01S-60

strong

szary / gray / серый

AM-ODB000-60

standard

tworzywo / plastic / пластмасса

AM-ODB000-10

biały / white / белый



Adapter AM-ODB prosty  
 Adapter AM-ODB straight  
 Адаптер AM-ODB прямой

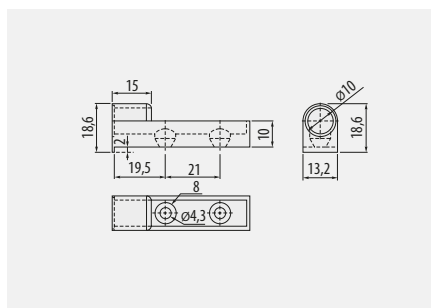

AM-ADAP0B-60	szary / gray / серый	tworzywo / plastic / пластмасса
AM-ADAP0B-10	biały / white / белый	



Adapter AM-ODB krzyżakowy  
 Cross adapter AM-ODB  
 Адаптер AM-ODB крестовой

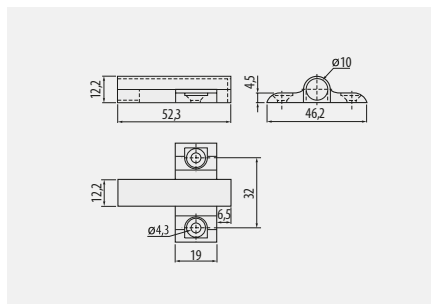

AM-ADAP0A-60	szary / gray / серый	tworzywo / plastic / пластмасса
AM-ADAP0A-10	biały / white / белый	



Odbojnik AM-OAD z adapterem  
Bumper with adapter AM-OAD  
Амортизатор с адаптером AM-OAD

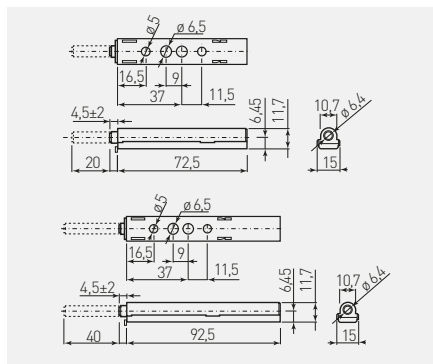

AM-OADS-DL-MG	z końcówką magnetyczną with magnetic tip магнитный наконечник	strong	dtugi / long / длинный	szary gray серый	tworzywo plastic пластмасса
AM-OADS-KR-MG		strong	krótki / short / короткий		
AM-OAD-DL-MG		standard	dtugi / long / длинный		
AM-OAD-KR-MG		standard	krótki / short / короткий		
AM-OADS-DL-GM	z końcówką kauczukową with rubber tip резиновый наконечник	strong	dtugi / long / длинный	szary gray серый	tworzywo plastic пластмасса
AM-OAD-DL-GM		standard	dtugi / long / длинный		
AM-OAD-KR-GM		strong	krótki / short / короткий		



Odbojnik AM-PL z adapterem  
Bumper with adapter AM-PL  
Амортизатор с адаптером AM-PL

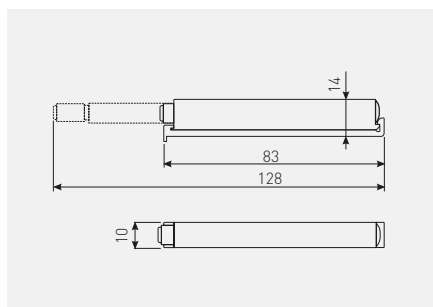

AM-PL-DL-MAG	z końcówką magnetyczną magnetic tip магнитный наконечник	szary gray серый	tworzywo plastic пластмасса
AM-PLA-DLU-0	z końcówką kauczukową with rubber tip каучуковый наконечник	szary gray серый	tworzywo plastic пластмасса



Odbojnik AM-OWP  
Bumper AM-OWP  
Амортизатор AM-OWP

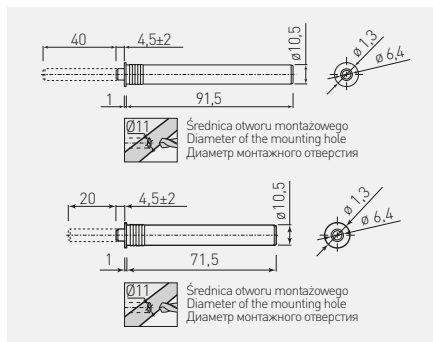

AM-OWPS-DL-MG	z końcówką magnetyczną with magnetic tip магнитный наконечник	strong	długi / long / длинный	szary gray серый	tworzywo plastic пластмасса
AM-OWPS-KR-MG		strong	krótki / short / короткий		
AM-OWP-DL-MG		standard	długi / long / длинный		
AM-OWP-KR-MG		standard	krótki / short / короткий		
AM-OWPS-DL-GM	z końcówką kauczukową with rubber tip резиновый наконечник	strong	długi / long / длинный		
AM-OWPS-KR-GM		strong	krótki / short / короткий		
AM-OWP-DL-GM		standard	długi / long / длинный		
AM-OWP-KR-GM		standard	krótki / short / короткий		



Odbojnik AM-ZAT zatraskowy  
Push latch AM-ZAT  
Амортизатор AM-ZAT на защелке

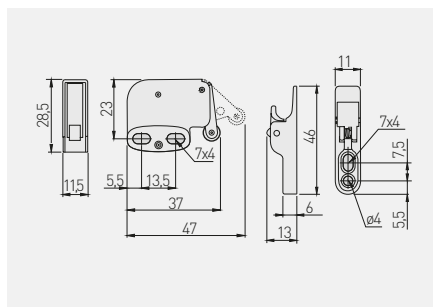



AM-ZAT-A1-10	biały white белый	stal, tworzywo steel, plastic сталь, пластмасса
--------------	-------------------------	---



Do zastosowania z zawiasem  
samootwierającym ZP-POH045ZE0  
Dedicated for GTV self opening  
hinge ZP-POH045ZE0  
Используется с самооткрывающейся  
петлей ZP-POH045ZE0

Amortyzator silikonowy  
Silicone damper dots  
Амортизатор силиконовый



	 wym. mm	
AMR-BP-1003	Ø 10 x 3	100 szt. / arkusz 100 pcs / sheet
AMR-BP-0715	Ø 7 x 1,5	100 szt. / лист





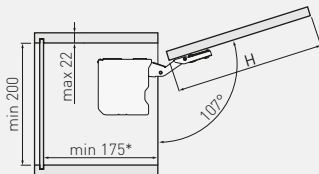

Podnośnik TOP STAYS  
TOP STAYS lift  
Подъемник TOP STAYS

NEW



- \* przy montażu z zawieszką min 240 mm
- \* when using a 240mm cabinet hanger
- \* при монтаже с подвеской min 240 мм

	Orientacyjna wysokość frontu Approximate front height Ориентировочная высота фасада	Współczynnik F Power Factor F Показатель F	Sprężyna Spring power Пружина		
PD-LIFT-LIGHT-10	250-400 mm	580-1250	light	biały / white / белый	stal steel сталь
PD-LIFT-LIGHT-80				szary / gray / серый	
PD-LIFT-MEDIUM-10	400-500 mm	960-2040	medium	biały / white / белый	
PD-LIFT-MEDIUM-80				szary / gray / серый	
PD-LIFT-STRONG-10	500 mm	1080-3500	strong	biały / white / белый	
PD-LIFT-STRONG-80				szary / gray / серый	

Współczynnik mocy F

F = wysokość frontu H (mm) x waga frontu łącznie z podwójną wagą uchwytu (kg)

Power Factor F

F = front height x front weight with doubled handle weight (kg)

Показатель мощности F

F = высота фасада H (мм) x вес фасада с удвоенным весом ручки (кг)



Podnośnik MOVE UP gazowy  
Gas stay lift MOVE UP  
Подъемник газовый MOVE UP

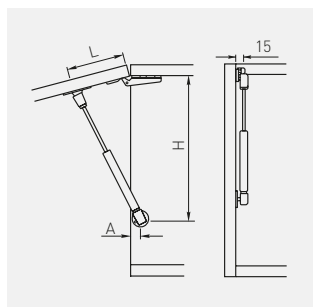

PD-G0050-N10	50 N	biały white белый	stal steel сталь
PD-G0060-N10	60 N		
PD-G0080-N10	80 N		
PD-G0100-N10	100 N		
PD-G0120-N10	120 N		
PD-G0050-N20	50 N	czarny black чёрный	
PD-G0060-N20	60 N		
PD-G0080-N20	80 N		
PD-G0100-N20	100 N		
PD-G0120-N20	120 N		



Kąt otwarcia drzwi Door opening angle Угол открывания дверей	Drzwi wpuszczane Inset door Внутренние дверцы			Drzwi bliźniacze Twin door Двойные дверцы			Drzwi nakładane Overlay door Наружные дверцы		
	H (mm)	L (mm)	A (mm)	H (mm)	L (mm)	A (mm)	H (mm)	L (mm)	A (mm)
75°	280	100	20 + grubość frontu 20 + front thicknes 20 + толщина фронта	272	100	25	264	100	25
90°	260	90		251	90	25	244	90	25
100°	250	80		242	80	25	234	80	25

Kąt otwarcia drzwi Door opening angle Угол открывания дверей	Siła podnośnika Load capacity Мощность подъемника	Wysokość drzwi (mm) / Door height (mm) / Высота дверцы (мм)			
		300	400	500	600
		Waga drzwi (kg) / Door weight (kg) / Вес дверцы (kg)			
75°	60 N	2.0	1.5	1.2	1.0
	80 N	2.7	2.0	1.6	1.4
90°	60 N	1.8	1.3	1.1	0.9
	80 N	2.4	1.8	1.4	1.2
100°	60 N	1.6	1.2	0.9	0.8
	80 N	2.1	1.6	1.2	1.0

Podnośnik gazowy standard  
Gas stay lift standard  
Подъемник газовый стандартный

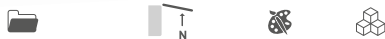
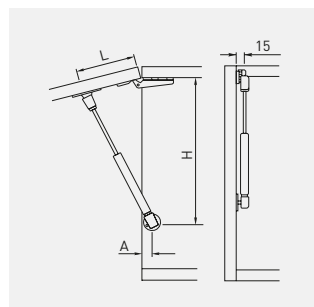

PD-G0050-N02	50 N	szary gray серый	stal steel сталь
PD-G0060-N02	60 N		
PD-G0080-N02	80 N		
PD-G0100-N02	100 N		
PD-G0120-N02	120 N		
PD-G0150-N02	150 N		



Kąt otwarcia drzwi Door opening angle Угол открывания дверей	Drzwi wpuszczane Inset door Внутренние двери			Drzwi bliźniacze Twin door Двойные двери			Drzwi nakładane Overlay door Наружные двери		
	H (mm)	L (mm)	A (mm)	H (mm)	L (mm)	A (mm)	H (mm)	L (mm)	A (mm)
75°	280	100	20 + grubość frontu 20 + front thickness 20 + толщина фронта	272	100	25	264	100	25
90°	260	90		251	90	25	244	90	25
100°	250	80		242	80	25	234	80	25

Kąt otwarcia drzwi Door opening angle Угол открывания дверей	Siła podnośnika Lift force Мощность подъемника	Wysokość drzwi (mm) / Door height (mm) / Высота двери (мм)			
		300	400	500	600
		Waga drzwi (kg) / Door weight (kg) / Вес двери (кг)			
75°	60 N	2.0	1.5	1.2	1.0
	80 N	2.7	2.0	1.6	1.4
	100 N	3.4	2.6	2.0	1.7
	120 N	4.1	3.1	2.5	2.0
	150 N	4.7	3.5	2.9	2.4
90°	60 N	1.8	1.3	1.1	0.9
	80 N	2.4	1.8	1.4	1.2
	100 N	3.0	2.2	1.8	1.5
	120 N	3.6	2.7	2.1	1.8
	150 N	4.1	3.2	2.3	2.1
100°	60 N	1.6	1.2	0.9	0.8
	80 N	2.1	1.6	1.2	1.0
	100 N	2.6	1.9	1.6	1.3
	120 N	3.1	2.3	1.9	1.6
	150 N	3.5	2.6	2.2	1.9

Podnośnik gazowy z amortyzatorem  
Gas stay with buffer  
Подъемник газовый с амортизатором

NEW

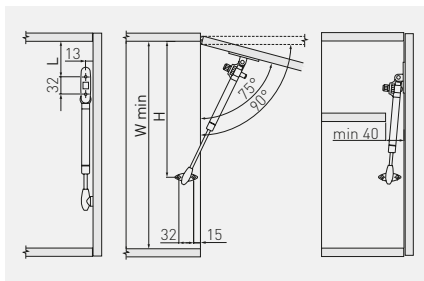

PD-GAM50-N02	50N	szary gray серый	stal steel сталь
PD-GAM60-N02	60N		
PD-GAM080-N02	80N		
PD-GAM100-N02	100N		
PD-GAM120-N02	120N		
PD-GAM150-N02	150N		

Kąt otwarcia drzwi Door opening angle Угол открывания дверей	H (mm)	L (mm)	W (mm)
75°	295	64	315
90°	275	52	300



Kąt otwarcia drzwi Door opening angle Угол открывания дверей	Siła podnośnika Lift force Мощность подъемника	Wysokość drzwi (mm) / Door height (mm) / Высота дверцы (мм)			
		300	400	500	600
		Waga drzwi (kg) / Door weight (kg) / Вес дверцы (кг)			
<p>75°</p>	50 N	1.6	1.2	1.0	0.8
	60 N	2.0	1.5	1.2	1.0
	80 N	2.7	2.0	1.6	1.4
	100 N	3.4	2.6	2.0	1.7
	120 N	4.1	3.1	2.5	2.0
	150 N	4.7	3.5	2.9	2.4
<p>90°</p>	50 N	1.5	1.1	0.9	0.7
	60 N	1.8	1.3	1.1	0.9
	80 N	2.4	1.8	1.4	1.2
	100 N	3.0	2.2	1.8	1.5
	120 N	3.6	2.7	2.1	1.8
	150 N	4.1	3.2	2.3	2.1

Podnośnik gazowy krótki  
Gas stay lift short  
Подъемник газовый короткий

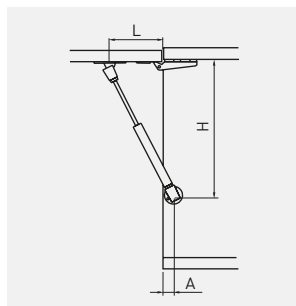

PD-G60160-N02	60 N	szary gray серый	stal steel сталь
PD-G80160-N02	80 N		



Kąt otwarcia drzwi Door opening angle Угол открывания дверей	Drzwi wpuszczane Inset door Внутренние дверцы			Drzwi bliźniacze Twin door Двойные дверцы			Drzwi nakładane Overlay door Наружные дверцы		
	H (mm)	L (mm)	A (mm)	H (mm)	L (mm)	A (mm)	H (mm)	L (mm)	A (mm)
75°	188	70	20 + grubość frontu 20 + front thickness 20 + толщина фронта	180	70	20	172	70	20
90°	176	60		167	60	20	160	60	20
100°	172	50		164	50	20	154	50	20

Kąt otwarcia drzwi Door opening angle Угол открывания дверей	Siła podnośnika Lift force Мощность подъемника	Wysokość drzwi (mm) / Door height (mm) / Высота дверцы (мм)			
		300	400	500	600
		Waga drzwi (kg) / Door weight (kg) / Вес дверцы (kr)			
75°	60 N	2.0	1.5	1.2	1.0
	80 N	2.7	2.0	1.6	1.4
90°	60 N	1.8	1.3	1.1	0.9
	80 N	2.4	1.8	1.4	1.2
100°	60 N	1.6	1.2	0.9	0.8
	80 N	2.1	1.6	1.2	1.0

Podnośnik DESIGN mechaniczny  
 Mechanical stay lift DESIGN  
 Подъемник механический DESIGN



PD-GPD01-001	chrom / chrome / хром	stal steel сталь
PD-GPD02-002	satyna / satin / сатин	
PD-GPD03-005	aluminium / алюминий	



Podnośnik do klap  
Flap lift  
Подъемник фасада

100°

12  $\varnothing 4,5$

32 90 135 37 100

Пłaszczyzna wewn. boku  
Inner side surface  
Поверхность боковой стенки

Podnośnik do klap  
Flap lift  
Подъемник фасада

75°

12  $\varnothing 4,5$

37 134 151 37 75

Пłaszczyzna wewn. boku  
Inner side surface  
Поверхность боковой стенки

Podnośnik do klap  
Flap lift  
Подъемник фасада

90°

12  $\varnothing 4,5$

32 91 159 37 90

Пłaszczyzna wewn. boku  
Inner side surface  
Поверхность боковой стенки

Wizualizacja dla zawiasów barkowych  
Drop Down Flap Stay  
Визуализация для барных петель

90°

12  $\varnothing 4,5$

32 91 153 37 90

Пłaszczyzna wewn. boku  
Inner side surface  
Поверхность боковой стенки

Wykres orientacyjnych wartości maksymalnego ciężaru w zależności od wysokości kłapy.

Maximum weight depending on the flap height

Максимальный вес фасада зависит от его высоты

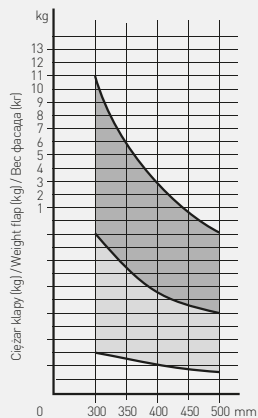
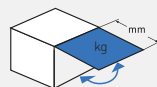

Wysokość kłapy [mm]  
Flap height [mm]  
Высота фасада [мм]

- 1 podnośnik  
1 stay lift  
1 подъемник
- 2 podnośniki  
2 stay lifts  
2 подъемника

Podnośnik mechaniczny standard  
 Mechanical stay lift standard  
 Подъемник механический стандартный



PD-PD000-001



chrom / chrome / хром



stal / steel / сталь



Podnośnik do klap  
 Flap lift  
 Поддержка фасада



100°

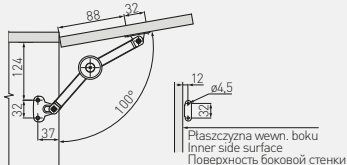

Podnośnik do klap  
 Flap lift  
 Поддержка фасада



75°

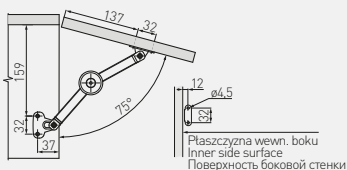

Podnośnik do klap  
 Flap lift  
 Поддержка фасада



90°

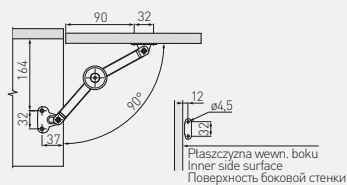

Rozwórka do klap.  
 Wizualizacja dla zawiasu barkowego  
 Drop Down Flap Stay  
 Поддержка фасада.  
 Визуализация для барных петель



90°



Wykres orientacyjnych wartości  
 maksymalnego ciężaru w zależności  
 od wysokości klap.

Maximum weight depending  
 on the flap height.

Максимальный вес фасада зависит  
 от его высоты

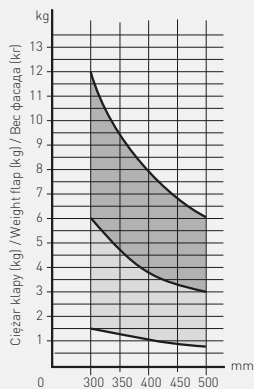
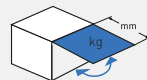

Wysokość klap (mm)  
 Flap height (mm)  
 Высота фасада (мм)

- 1 podnośnik  
1 stay lift  
1 подъемник
- 2 podnośniki  
2 stay lifts  
2 подъемника

## Amortyzator VIM do klap barkowych, krótki VIM stay lift for drop down cabinet doors - short Амортизатор барный, короткий VIM



Produkt kompatybilny z zawiasem barkowym: PD-MD-ZB

Compatible with flap hinge: PD-MD-ZB

Продукт совместим с барной петлей: PD-MD-ZB

		
PD-MDLIFT-P1-D	szary gray серый	stal steel сталь



Orientacyjna tabela wartości doboru podnośników, w zależności od szerokości i wysokości kłapy.

Maximum weight depending on the flap height.

Таблица подбора амортизатора в зависимости от ширины и высоты фасада.

Wysokość Height Высота	Szerokość [mm] / Width [mm] / Ширина (мм)			
	600 mm	700 mm	800 mm	900 mm
	Ilość amortyzatorów Number of lifts Количество амортизаторов			
250 mm	1	1	2	2
260 mm	1	1	2	2
270 mm	1	1	2	2
280 mm	1	2	2	2
290 mm	1	2	2	2
300 mm	1	2	2	2
310 mm	1	2	2	2
320 mm	1	2	2	2
330 mm	1	2	2	2
340 mm	1	2	2	2

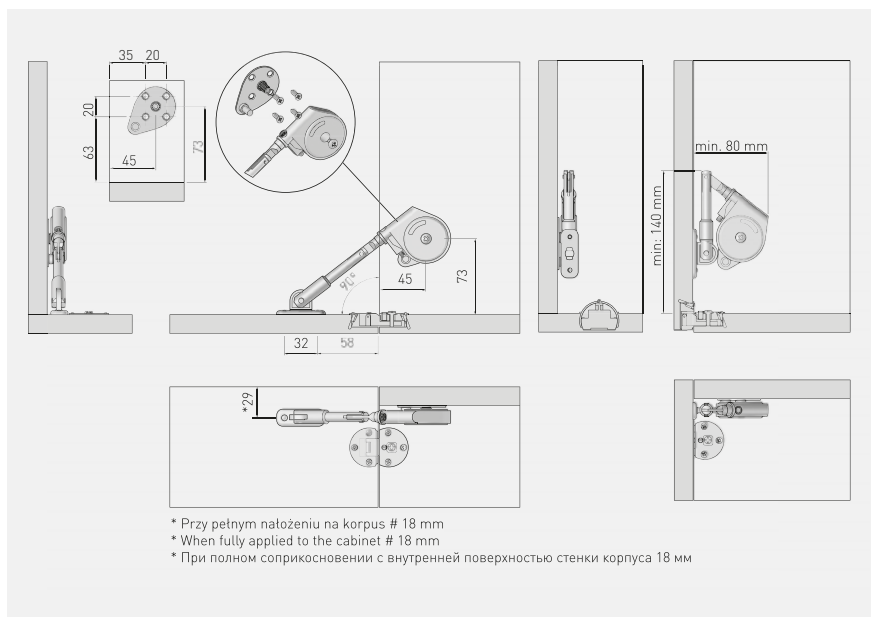



Amortyzator VIM do klap barkowych, długi  
 VIM stay lift for drop down cabinet doors - long  
 Амортизатор барный, длинный VIM



Produkt kompatybilny z zawiasem barkowym: PD-MD-ZB

Compatible with flap hinge: PD-MD-ZB

Продукт совместим с барной петлей: PD-MD-ZB

		
PD-MDLIFT-P2-D	szary gray серый	stal steel сталь



Orientacyjna tabela wartości doboru podnośników, w zależności od szerokości i wysokości kłapy.  
 Maximum weight depending on the flap height.

Таблица подбора амортизатора в зависимости от ширины и высоты фасада.

Wysokość Height Высота	Szerokość / Width / Ширина			
	600 mm	700 mm	800 mm	900 mm
	Ilość amortyzatorów Number of lifts Количество амортизаторов			
350 mm	1	2	2	2
360 mm	1	2	2	2
370 mm	1	2	2	2
380 mm	1	2	2	2
390 mm	1	2	2	2
400 mm	1	2	2	2

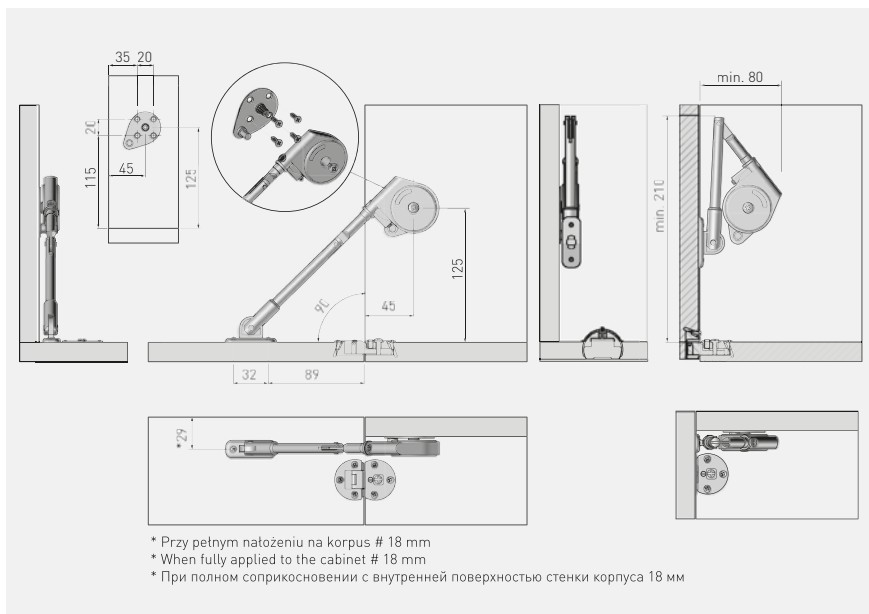

Amortyzator olejowy do klap barkowych  
 Oil stay lift for drop down cabinet doors  
 Амортизатор маслянный барный

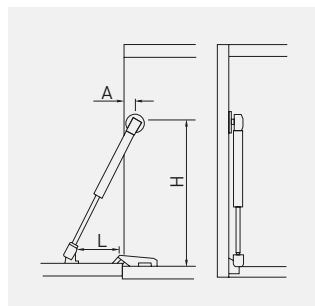

PD-ECGDL-060	60 N	szary gray серый	stal steel сталь
PD-ECGDL-080	80 N		
PD-ECGDL-150	150 N		



Kąt otwarcia drzwi Door opening angle Угол открывания дверей	Drzwi wpuszczane Inset door Внутренние дверцы			Drzwi bliźniacze Twin door Двойные дверцы			Drzwi nakładane Overlay door Наружные дверцы		
	H (mm)	L (mm)	A (mm)	H (mm)	L (mm)	A (mm)	H (mm)	L (mm)	A (mm)
90°	260	90	45	253	90	25	246	90	25

Kąt otwarcia drzwi Door opening angle Угол открывания дверей	Siła podnośnika Lift force Мощность подъемника	Wysokość drzwi (mm) / Door height (mm) / Высота дверцы (мм)			
		300	400	500	600
		Waga drzwi (kg) / Door weight (kg) / Вес дверцы (кг)			
 90°	60 N	1.8	1.3	1.1	0.9
	80 N	2.4	1.8	1.4	1.2
	150 N	4.1	3.2	2.3	2.1



Prowadnica dolnego montażu ze spowalniczem 3DSLIDE  
 Undermount drawer slide with soft closing 3DSLIDE  
 Направляющая нижнего монтажа с доводчиком 3DSLIDE

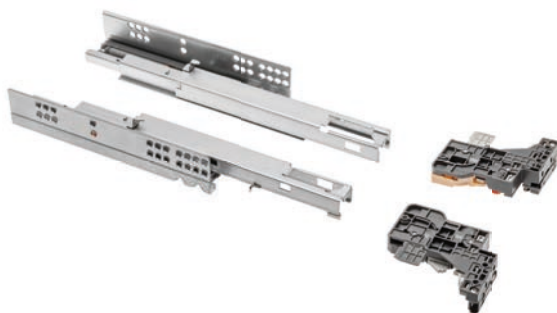

Rozstaw otworów montażowych  
 Mounting dimensions  
 Монтажные отверстия

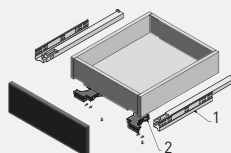
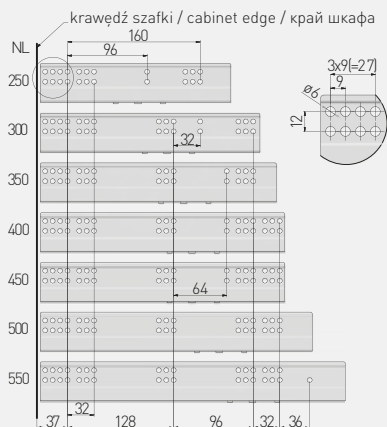

1. prowadnica lewa/prawa  
 drawer slide L/R  
 направляющая Л/П
2. sprzęgło lewe/prawe + wkręty  
 locking device L/R + screws  
 крепления фасада Л/П + саморезы

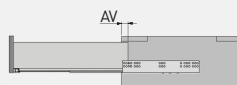

NL = długość nominalna prowadnicy  
 nominal slide length  
 номинальная длина направляющей

AV = strata wysuwu  
 extension loss  
 потеря на выдвигении

Uwagi montażowe: dla prawidłowego działania szuflady jej szerokość nie może przekraczać długości nominalnej prowadnicy.  
 Mounting information: for proper drawer operation, the width of the drawer can not exceed the nominal slide length.  
 Техническое примечание: ширина ящика не должна превышать длину направляющей.

	L mm	AV mm				
PB-3DSLIDE-250	250	25	petny full полное	40	ocynk galvanized гальваника	stal
PB-3DSLIDE-270	270	25				
PB-3DSLIDE-300	300	25				
PB-3DSLIDE-350	350	25				
PB-3DSLIDE-400	400	25				
PB-3DSLIDE-450	450	25				
PB-3DSLIDE-500	500	25				
PB-3DSLIDE-550	550	25				

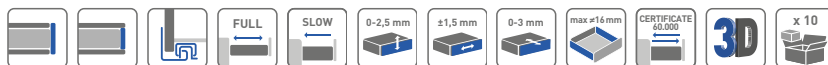

Prowadnica dolnego montażu ze spowalniaczem 0SHX

Undermount drawer slide with soft closing 0SHX

Направляющая нижнего монтажа полного выдвижения с доводчиком 0SHX



Rozstaw otworów montażowych  
Mounting dimensions  
Монтажные отверстия

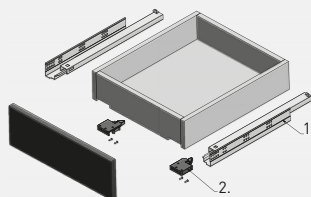
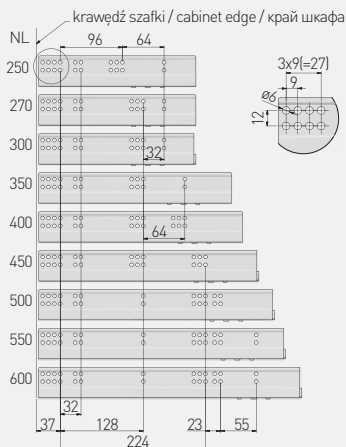

1. prowadnica lewa/prawa  
drawer slide L/R  
направляющая Л/П
2. sprzęgło lewe/prawe + wkręty  
locking device L/R + screws  
крепления фасада Л/П + саморезы

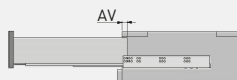

NL = długość nominalna prowadnicy  
nominal slide length  
номинальная длина направляющей

AV = strata wysuwu  
extension loss  
потеря на выдвижении

Uwagi montażowe: dla prawidłowego działania szuflady jej szerokość nie może przekraczać długości nominalnej prowadnicy.  
Mounting information: for proper drawer operation, the width of the drawer can not exceed the nominal slide length.  
Техническое примечание: ширина ящика не должна превышать длину направляющей.

	L mm	AV mm		kg		
PB-0SHX-250-A	250	16	petny full полное	35	ocynk galvanized гальваника	stal steel сталь
PB-0SHX-270-A	270	16				
PB-0SHX-300-A	300	16				
PB-0SHX-350-A	350	16				
PB-0SHX-400-A	400	16				
PB-0SHX-450-A	450	16				
PB-0SHX-500-A	500	16				
PB-0SHX-550-A	550	16				
PB-0SHX-600-A	600	16				



Prowadnica dolnego montażu ze spowalniczem 0SHX-18  
 Undermount drawer slide with soft closing 0SHX-18  
 Направляющая нижнего монтажа полного выдвижения с доводчиком 0SHX под под плиту 18 мм



Rozstaw otworów montażowych  
 Mounting dimensions  
 Монтажные отверстия

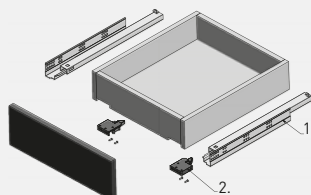
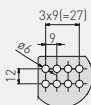
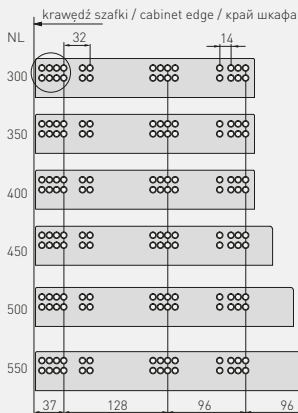

1. prowadnica lewa/prawa  
 drawer slide L/R  
 направляющая Л/П
2. sprzęgło lewe/prawe + wkręty  
 locking device L / R + screws  
 крепление фасада Л/П + саморезы

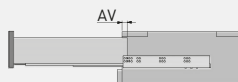

NL = długość nominalna prowadnicy  
 nominal slide length  
 номинальная длина направляющей

AV = strata wysuwu  
 extension loss  
 потеря на выдвижении

Uwagi montażowe: dla prawidłowego działania szuflady jej szerokość nie może przekraczać długości nominalnej prowadnicy.  
 Mounting information: for proper drawer operation, the width of the drawer can not exceed the nominal slide length.  
 Техническое примечание: ширина ящика не должна превышать длину направляющей.

	 L mm	 AV mm		 kg		
PB-0SHX18-300-H	300	16	pełny full полное	30	ocynk galvanized гальванیکا	stal steel сталь
PB-0SHX18-350-H	350	16				
PB-0SHX18-400-H	400	16				
PB-0SHX18-450-H	450	16				
PB-0SHX18-500-H	500	16				
PB-0SHX18-550-H	550	16				



Prowadnica dolnego montażu ze spowalniaczem OSHX-H

Undermount drawer slide with soft closing OSHX-H

Направляющая нижнего монтажа полного выдвижения с доводчиком OSHX-H

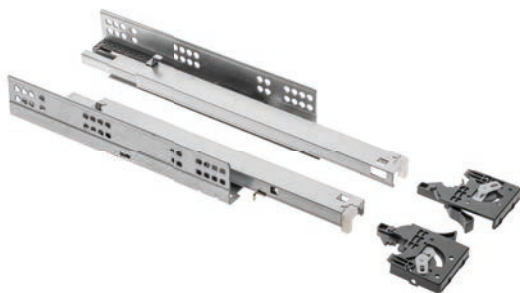

Rozstaw otworów montażowych  
Mounting dimensions  
Монтажные отверстия

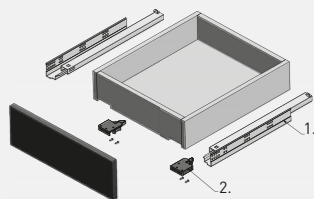
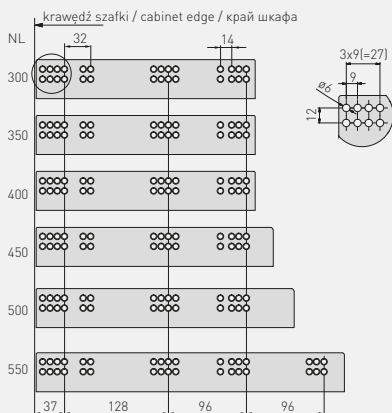







1. prowadnica lewa/prawa  
drawer slide L/R  
направляющая Л/П
2. sprzęgło lewe/prawe + wkręty  
locking device L / R + screws  
крепления фасада Л/П + саморезы



NL = długość nominalna prowadnicy  
nominal slide length  
номинальная длина направляющей  
AV = strata wysuwu  
extension loss  
потеря на выдвижении

Uwagi montażowe: dla prawidłowego działania szuflady jej szerokość nie może przekraczać długości nominalnej prowadnicy.  
Mounting information: for proper drawer operation, the width of the drawer can not exceed the nominal slide length.  
Техническое примечание: ширина ящика не должна превышать длину направляющей.

	 L mm	 AV mm		 kg		
PB-OSHX-300-H	300	16	petny full полное	25		stal galvanized гальваника
PB-OSHX-350-H	350	16				
PB-OSHX-400-H	400	16				
PB-OSHX-450-H	450	16				
PB-OSHX-500-H	500	16				
PB-OSHX-550-H	550	16				



Prowadnica dolnego montażu ze spowalniczem S10C  
 Undermount drawer slide with soft closing S10C  
 Направляющая нижнего монтажа с доводчиком S10C

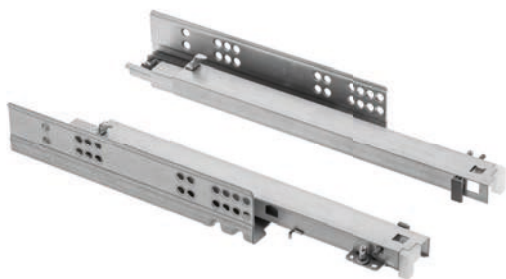

Kotek blokujący (zabezpieczenie przed wypadnięciem szuflady)  
 Blocking peg (prevents drawer from falling out)  
 Ограничитель (защита от выпадения ящика)

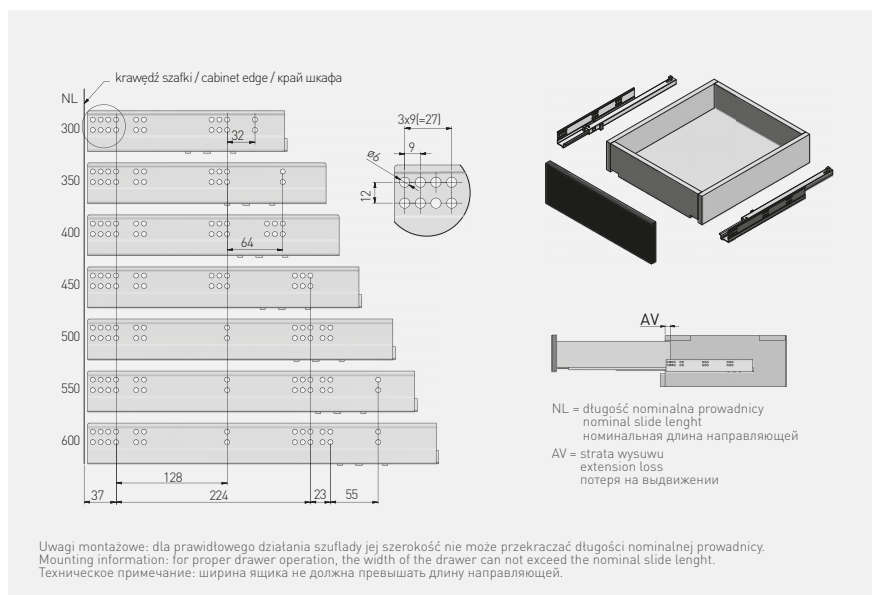

	L mm	AV mm		kg		
PB-S10C300HX	300	28	petny full полное	25	ocynk galwaniz гальваника	stal steel сталь
PB-S10C350HX	350	28				
PB-S10C400HX	400	28				
PB-S10C450HX	450	28				
PB-S10C500HX	500	28				
PB-S10C550HX	550	28				
PB-S10C600HX	600	28				





Prowadnica dolnego montażu Push to open OFPO  
 Undermount drawer slide Push to open OFPO  
 Направляющая нижнего монтажа Push to open OFPO



Możliwość zastosowania stabilizatora  
 Can be used with stabilizer  
 Возможность использования стабилизатора  
 PB-D-P20STAB

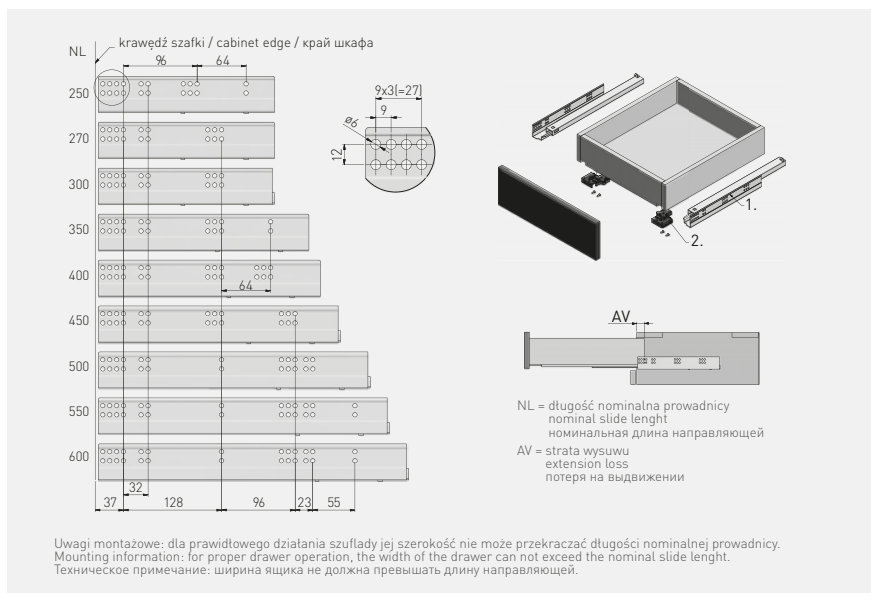

	L mm	AV mm				
PB-0FPO-250	250	26	25	pełny full полное	ocynk galvanized гальваника	stal steel сталь
PB-0FPO-270	270	26				
PB-0FPO-300	300	26				
PB-0FPO-350	350	26				
PB-0FPO-400	400	26				
PB-0FPO-450	450	26				
PB-0FPO-500	500	26				
PB-0FPO-600	600	26				







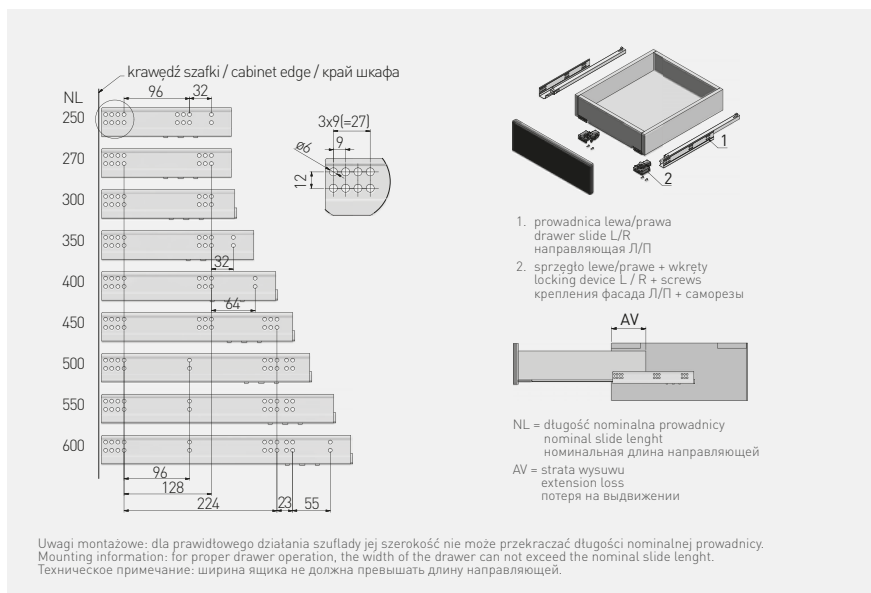

Prowadnica dolnego montażu ze spowalniczem GCHX

Undermount drawer slide with soft closing GCHX

Направляющая нижнего монтажа неполного выдвижения с доводчиком GCHX



		 L mm	 AV mm		 kg		
PB-GCHX-250		250	98,5	niepełny partial неполное	25	ocynk galvanized гальваника	stal steel сталь
PB-GCHX-270		270	98,5				
PB-GCHX-300		300	98,5				
PB-GCHX-350		350	98,5				
PB-GCHX-400		400	118,5				
PB-GCHX-450		450	118,5				
PB-GCHX-500		500	118,5				
PB-GCHX-550		550	138,5				
PB-GCHX-600		600	138,5				



Prowadnice dolnego montażu ze spowalniczem G10HX

Undermount drawer slide with soft closing G10HX

Направляющая нижнего монтажа неполное выдвижение с доводчиком G10HX









Kotek blokujący (zabezpieczenie przed wypadnięciem szuflady)  
Blocking peg (prevents drawer from falling out)  
Ограничитель (защита от выпадения ящика)

Technical drawing showing dimensions for various cabinet heights (250mm to 600mm). Dimensions include nominal slide length (NL) and extension loss (AV). A diagram shows a drawer assembly with dimensions 3x9(=27) and 86. A table below lists the dimensions for each height.

Height (mm)	Dimension 1 (mm)	Dimension 2 (mm)	Dimension 3 (mm)	Dimension 4 (mm)	Dimension 5 (mm)
250	96	32			
270					
300			32		
350				64	
400					
450					
500					
550					
600	37	96	32	96	23 55

NL = długość nominalna prowadnicy  
 nominal slide length  
 номинальная длина направляющей  
 AV = strata wysuwu  
 extension loss  
 потеря на выдвижении





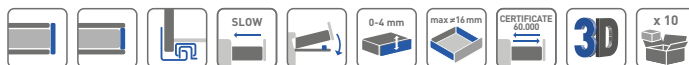

Uwagi montażowe: dla prawidłowego działania szuflady jej szerokość nie może przekraczać długości nominalnej prowadnicy.  
 Mounting information: for proper drawer operation, the width of the drawer can not exceed the nominal slide length.  
 Техническое примечание: ширина ящика не должна превышать длину направляющей.

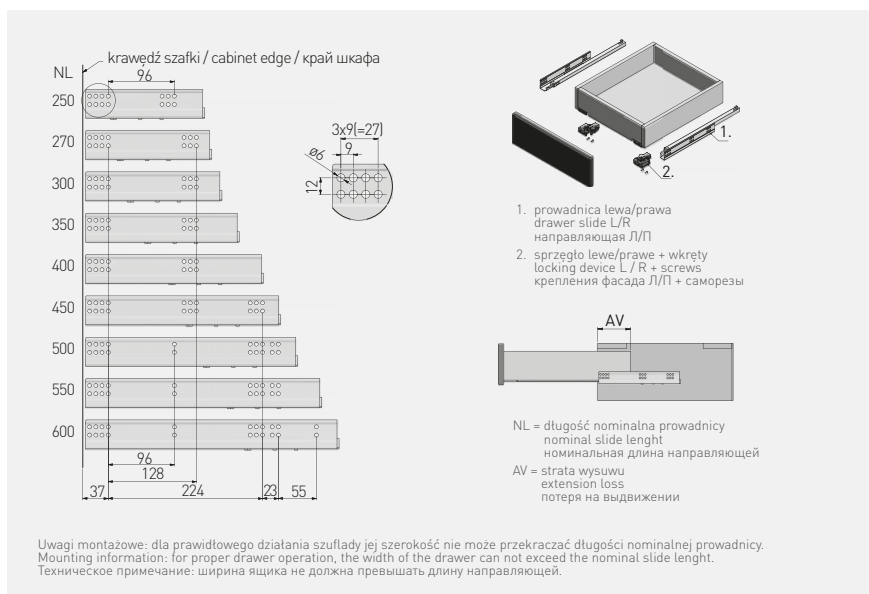
		 L mm	 AV mm		 kg		
PB-G10HX250		250	86,5	niepełny partial неполное	25	ocynk galvanized гальваника	stal steel сталь
PB-G10HX270		270	86,5				
PB-G10HX300		300	86,5				
PB-G10HX350		350	86,5				
PB-G10HX400		400	106,5				
PB-G10HX450		450	106,5				
PB-G10HX500		500	106,5				
PB-G10HX550		550	126,5				
PB-G10HX600		600	126,5				



Prowadnica dolnego montażu Push to open GAPO  
 Undermount drawer slide Push to open GAPO  
 Направляющая нижнего монтажа неполное выдвижение Push to open GAPO







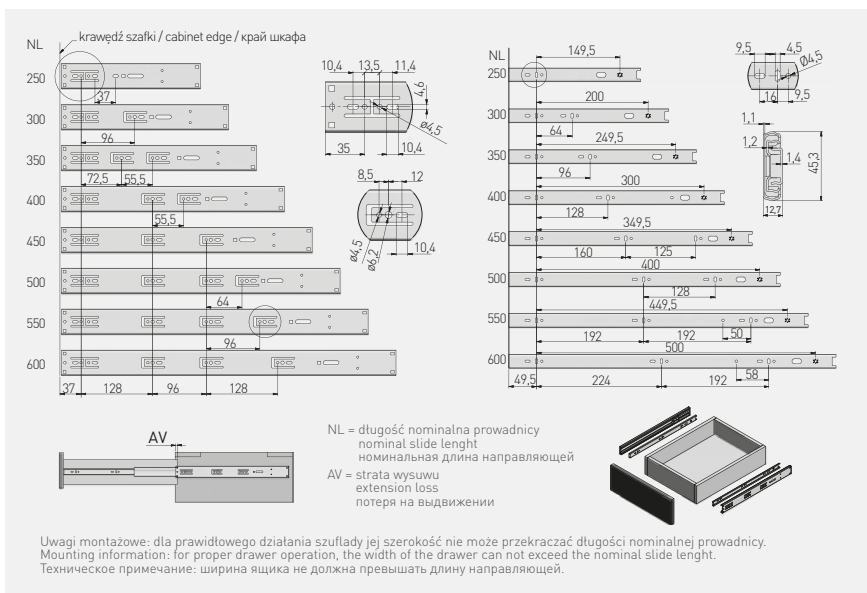

		 L mm	 AV mm				
PB-GAPO-250		250	98,5	niepełny partial неполное	25	ocynk galvanized гальваника	stal steel сталь
PB-GAPO-270		270	98,5				
PB-GAPO-300		300	98,5				
PB-GAPO-350		350	98,5				
PB-GAPO-400		400	118,5				
PB-GAPO-450		450	118,5				
PB-GAPO-500		500	118,5				
PB-GAPO-550		550	138,5				
PB-GAPO-600		600	138,5				



Prowadnica kulkowa VERSALITE PLUS ze spowalniaczem H45  
 Ball bearing slides VERSALITE PLUS with soft closing H45  
 Шариковая направляющая VERSALITE PLUS с доводчиком H45







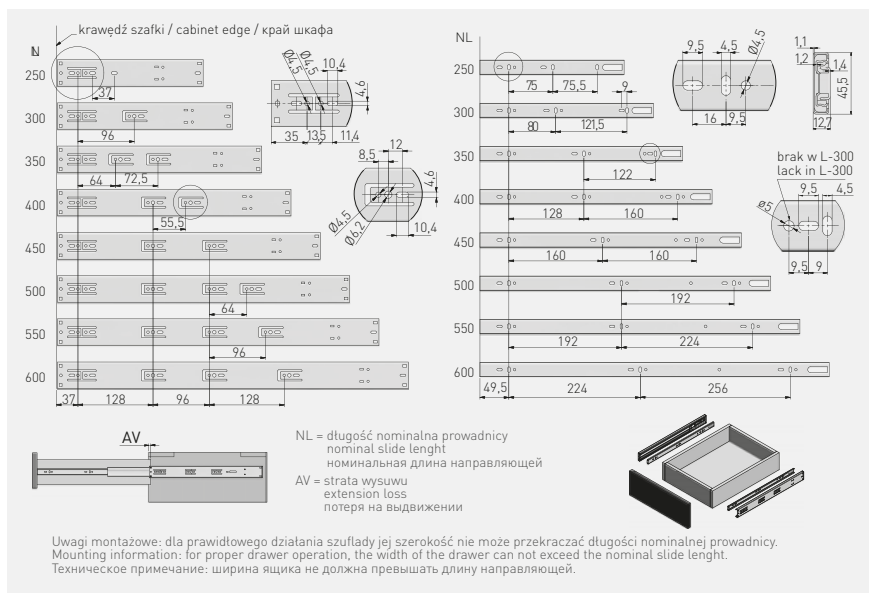

	 L mm	 AV mm		 kg		
PK-L-H45-250	250*	102	pełny full полное	30		stal steel сталь
PK-L-H45-300	300*	52				
PK-L-H45-350	350*	35				
PK-L-H45-400	400*	20				
PK-L-H45-450	450*	4				
PK-L-H45-500	500*	4				
PK-L-H45-600	600*	4				

\* Brak pełnego wysuwu / Not full extension / Неполное выдвижение



Prowadnica kulkowa VERSALITE ze spawalniaczem H45  
 Ball bearing slides VERSALITE with soft closing H45  
 Шариковая направляющая VERSALITE с доводчиком H45



		 L mm	 AV mm	 kg		
PK-L-H45-250-A		250*	55	30	osynek galvanized гальванка	stal steel сталь
PK-L-H45-300-A		300	15			
PK-L-H45-350-A		350	5			
PK-L-H45-400-A		400	5			
PK-L-H45-450-A		450	5			
PK-L-H45-500-A		500	0			
PK-L-H45-550-A		550	0			
PK-L-H45-600-A		600	0			

\*Brak pełnego wysuwu / Not full extension / Неполное выдвигение



Prowadnica kulkowa VERSALITE LIGHT ze spowalniaczem H45  
 Ball bearing slides VERSALITE LIGHT with soft closing H45  
 Шариковая направляющая VERSALITE LIGHT с доводчиком H45

NEW









krawędź szafki / Cabinet edge / край шкафа / Schrankrand

NL = długość nominalna prowadnicy  
 nominal slide length  
 номинальная длина направляющей

AV = strata wysuwu  
 extension loss  
 потеря на выдвигании

Uwagi montażowe: dla prawidłowego działania szuflady jej szerokość nie może przekraczać długości nominalnej prowadnicy.  
 Mounting information: for proper drawer operation, the width of the drawer can not exceed the nominal slide length.  
 Техническое примечание: ширина ящика не должна превышать длину направляющей.

	 L mm	 AV mm		 kg		
PK-L-H45-300-GX	300	50	petny full полное	25	ocynk galvanized гальванка	stal steel сталь
PK-L-H45-350-GX	350	20				
PK-L-H45-400-GX	400	-				
PK-L-H45-450-GX	450	-				
PK-L-H45-500-GX	500	-				
PK-L-H45-550-GX	550	-				
PK-L-H45-600-GX	600	-				



Prowadnice kulkowa z samodociąganiem H45  
 Ball bearing slides with self closing H45  
 Шариковая направляющая с фиксатором H45

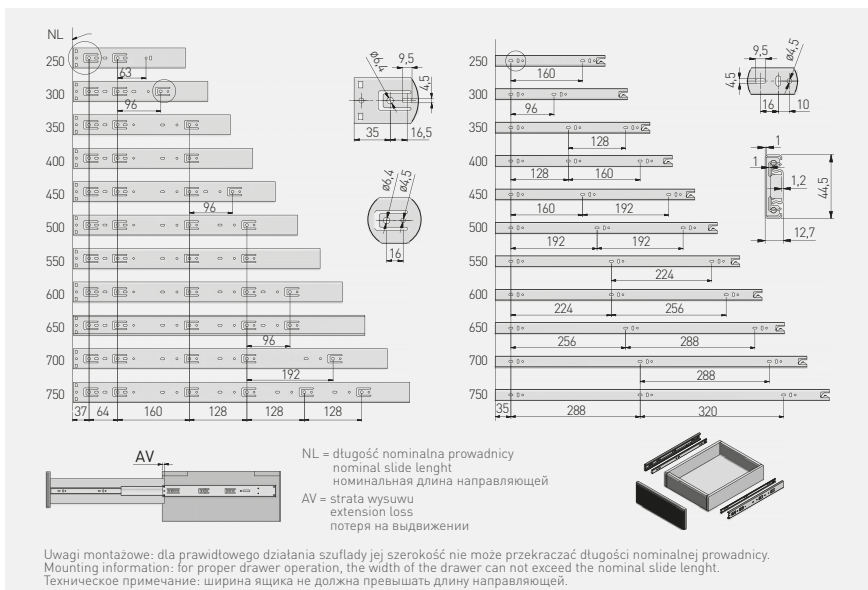

	L mm	AV mm		kg		
PK-S-H45-250	250*	22	pełny full полное	35	ocynk galvanized гальванка	stal steel сталь
PK-S-H45-300	300	-				
PK-S-H45-350	350	-				
PK-S-H45-400	400	-				
PK-S-H45-450	450	-				
PK-S-H45-500	500	-				
PK-S-H45-550	550	-				
PK-S-H45-600	600	-				
PK-S-H45-650	650	-				
PK-S-H45-700	700	-				

\* Brak pełnego wysuwu / Not full extension / Неполное выдвигение





Prowadnica kulkowa Push to open H45  
 Ball bearing slides Push to open H45  
 Шариковая направляющая Push to open H45



Możliwość zastosowania stabilizatora  
 Can be used with stabilizer  
 Возможность использования стабилизатора  
 PB-D-P20STAB

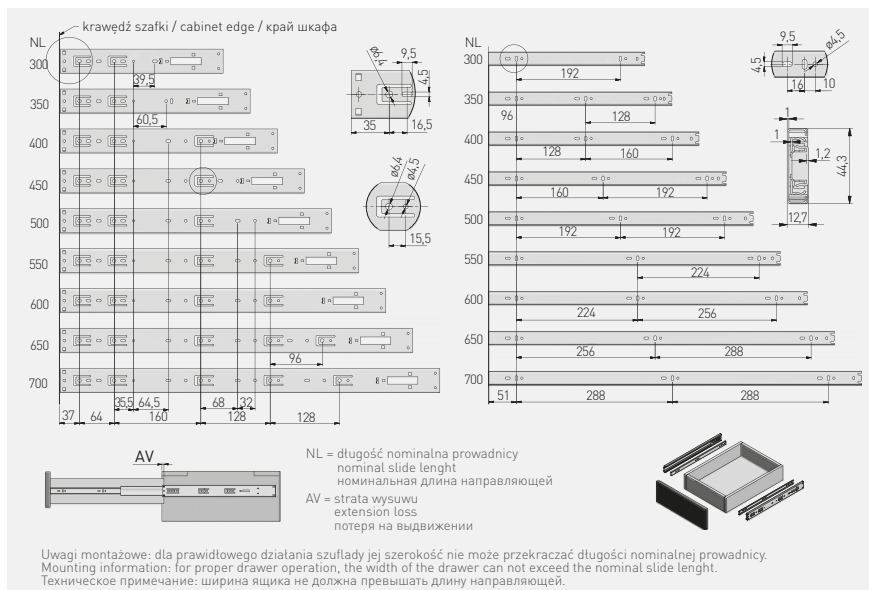

	L mm	AV mm		kg		
PK-P-0H45-300A	300*	20	petny full полное	25	ocynk galvanized гальванка	stal steel сталь
PK-P-0H45-350A	350	-				
PK-P-0H45-400A	400	-				
PK-P-0H45-450A	450	-				
PK-P-0H45-500A	500	-				
PK-P-0H45-550A	550	-				
PK-P-0H45-600A	600	-				
PK-P-0H45-650A	650	-				
PK-P-0H45-700A	700	-				

\* brak pełnego wysuwu / not full extension / Неполное выдвижение



Prowadnica kulkowa H45 PRESTIGE  
Ball bearing slide H45 PRESTIGE  
Шариковая направляющая H45 RESTIGE



NL - krawędź szafki / cabinet edge / край шкафа

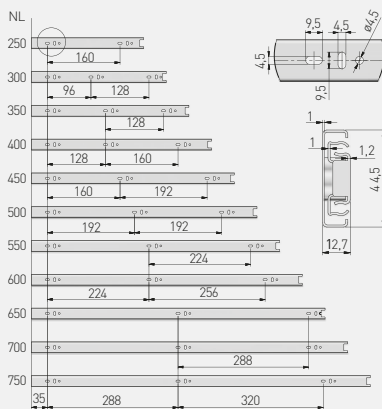
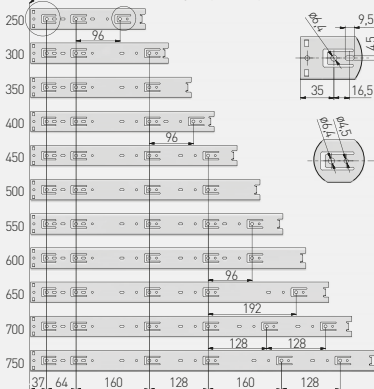





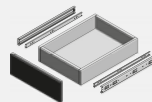

NL = długość nominalna prowadnicy  
nominal slide length  
номинальная длина направляющей

AV = strata wysuwu  
extension loss  
потеря на выдвижении









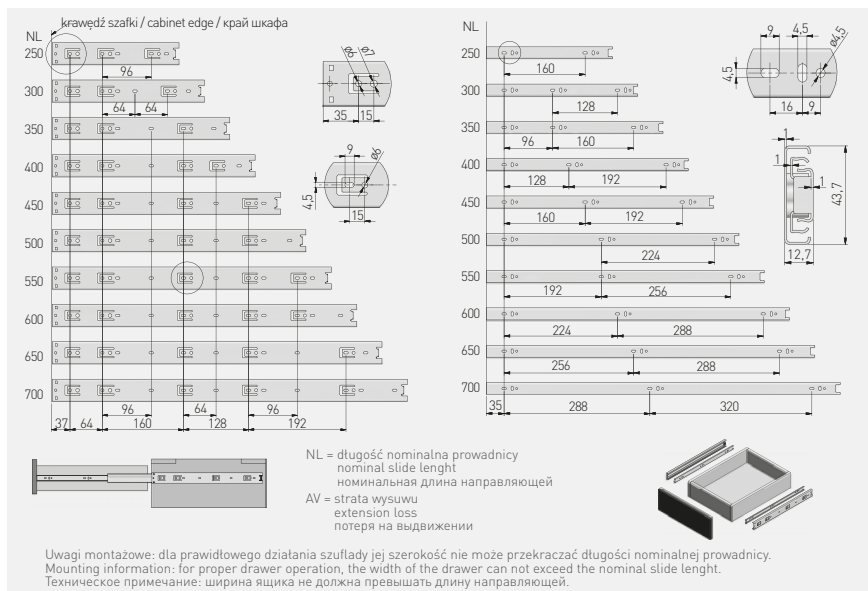

Uwagi montażowe: dla prawidłowego działania szuflady jej szerokość nie może przekraczać długości nominalnej prowadnicy.  
Mounting information: for proper drawer operation, the width of the drawer can not exceed the nominal slide length.  
Техническое примечание: ширина ящика не должна превышать длину направляющей.

	 L mm	 AV mm		 kg		
PK-0-H45-250	250	-	pełny full полное	35	ocynk galvanized гальваника	stal steel сталь
PK-0-H45-300	300	-				
PK-0-H45-350	350	-				
PK-0-H45-400	400	-				
PK-0-H45-450	450	-				
PK-0-H45-500	500	-				
PK-0-H45-550	550	-				
PK-0-H45-600	600	-				
PK-0-H45-700	700	-				



Prowadnica kulkowa XP  
Ball bearing slides XP  
Шариковая направляющая XP







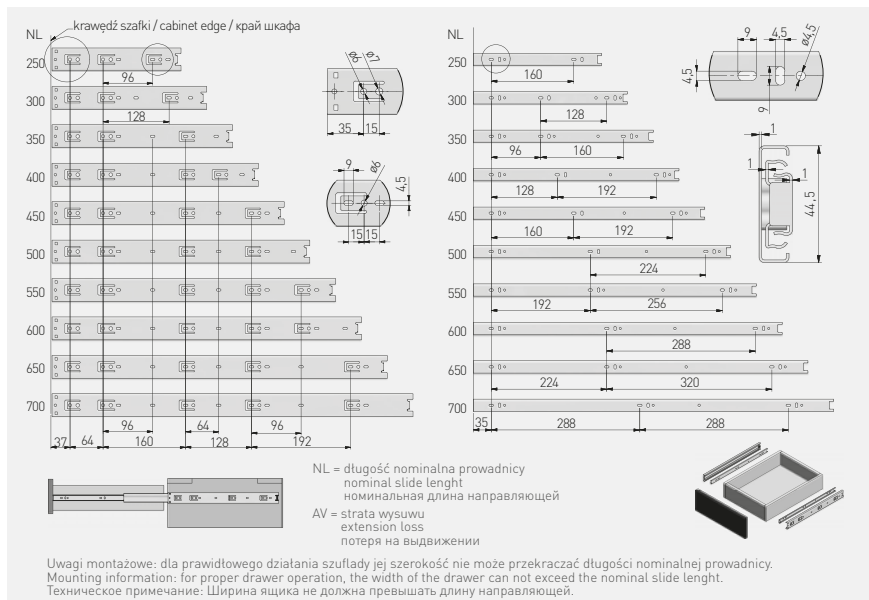

		 L mm	 AV mm		 kg		
PK-0H45250XP		250	-	pełny full полное	30	ocynk galvanized гальваника	stal steel сталь
PK-0H45300XP		300	-				
PK-0H45350XP		350	-				
PK-0H45400XP		400	-				
PK-0H45450XP		450	-				
PK-0H45500XP		500	-				
PK-0H45550XP		550	-				
PK-0H45600XP		600	-				
PK-0H45650XP		650	-				
PK-0H45700XP		700	-				



Prowadnica kulkowa H45 GX  
Ball bearing slides H45 GX  
Шариковая направляющая H45 GX







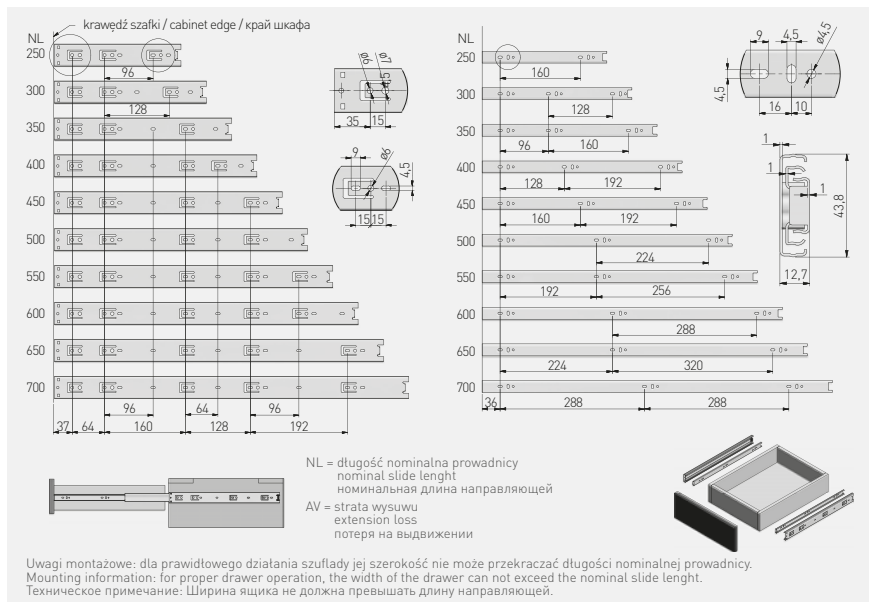

		 L mm	 AV mm		 kg		
PK-0H45250GX		250	5	pełny full полное	30	ocynk galvanized гальваника	stal steel сталь
PK-0H45300GX		300	-				
PK-0H45350GX		350	-				
PK-0H45400GX		400	-				
PK-0H45450GX		450	-				
PK-0H45500GX		500	-				
PK-0H45550GX		550	-				
PK-0H45600GX		600	-				
PK-0H45700GX		700	-				



Prowadnica kulkowa H45 GX1  
Ball bearing slides H45 GX1  
Шариковая направляющая H45 GX1



	 L mm	 AV mm		 kg		
PK-0H45250GX1	250	5	pełny full полное	30	ocynk galvanized гальваника	stal steel сталь
PK-0H45300GX1	300	-				
PK-0H45350GX1	350	-				
PK-0H45400GX1	400	-				
PK-0H45450GX1	450	-				
PK-0H45500GX1	500	-				
PK-0H45550GX1	550	-				
PK-0H45600GX1	600	-				
PK-0H45700GX1	700	-				



Prowadnica kulkowa VERSALITE ze spowalniaczem H35  
 Ball bearing slides VERSALITE with soft closing H35  
 Шариковая направляющая VERSALITE с доводчиком H35

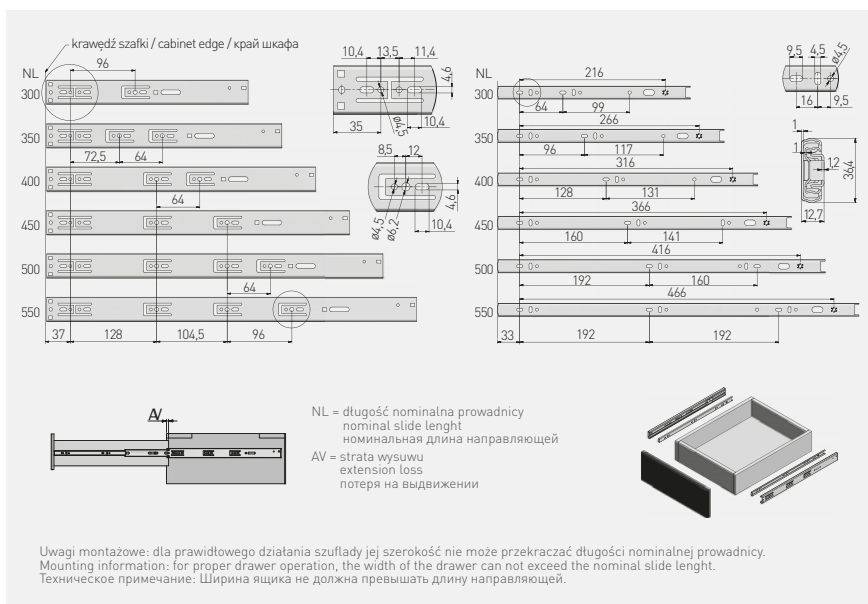







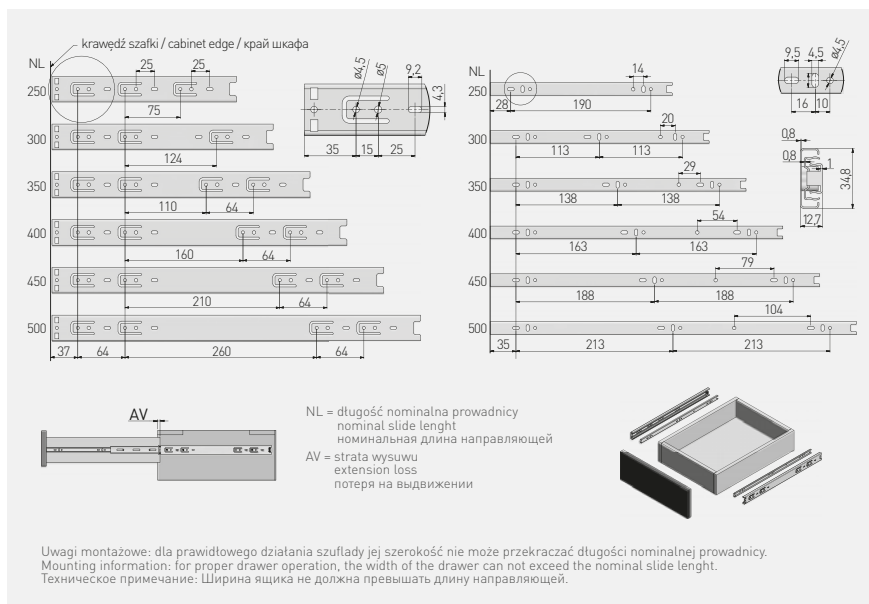

	L mm	AV mm		kg		
PK-L-H35-300	300*	52	pełny full полное	20	ocynk galvanized гальваника	stal steel сталь
PK-L-H35-350	350*	35				
PK-L-H35-400	400*	20				
PK-L-H35-450	450	4				
PK-L-H35-500	500	4				
PK-L-H35-550	550	4				

\* Brak pełnego wysuwu / Not full extension / Неполное выдвигание



Prowadnica kulkowa H35  
Ball bearing slide H35  
Шариковая направляющая H35







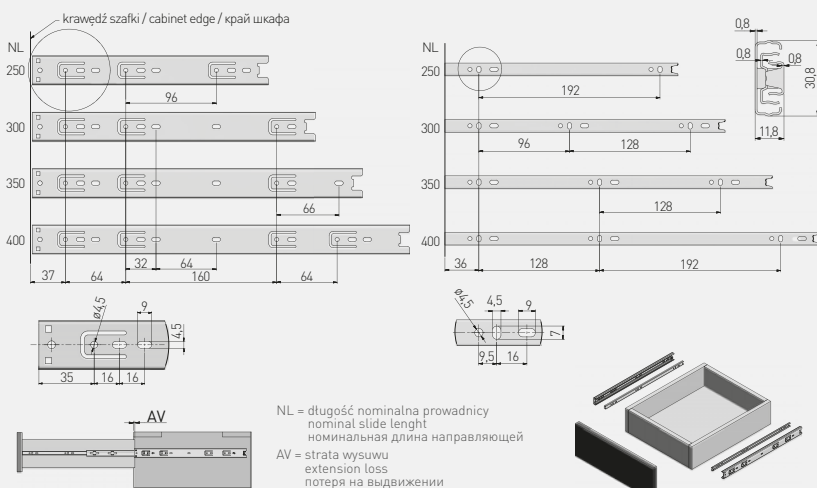

	 L mm	 AV mm		 kg		
PK-0H35-2500	250	4	pełny full полное	25	osynek galvanized гальваника	stal steel сталь
PK-0-H35-3000	300	4				
PK-0-H35-3500	350	4				
PK-0-H35-4000	400	4				
PK-0-H35-4500	450	4				
PK-0-H35-5000	500	4				



Prowadnica kulkowa H30  
Ball bearing slide H30  
Шариковая направляющая H30



Uwagi montażowe: dla prawidłowego działania szuflady jej szerokość nie może przekraczać długości nominalnej prowadnicy.  
Mounting information: for proper drawer operation, the width of the drawer can not exceed the nominal length of the slide.  
Техническое примечание: Ширина ящика не должна превышать длину направляющей.







		 L mm	 AV mm		 kg		
PK-0H30-2500		250	-	petny full полное	15	ocynk galvanized гальваника	stal steel сталь
PK-0H30-3000		300	-				
PK-0H30-3500		350	-				
PK-0H30-4000		400	-				

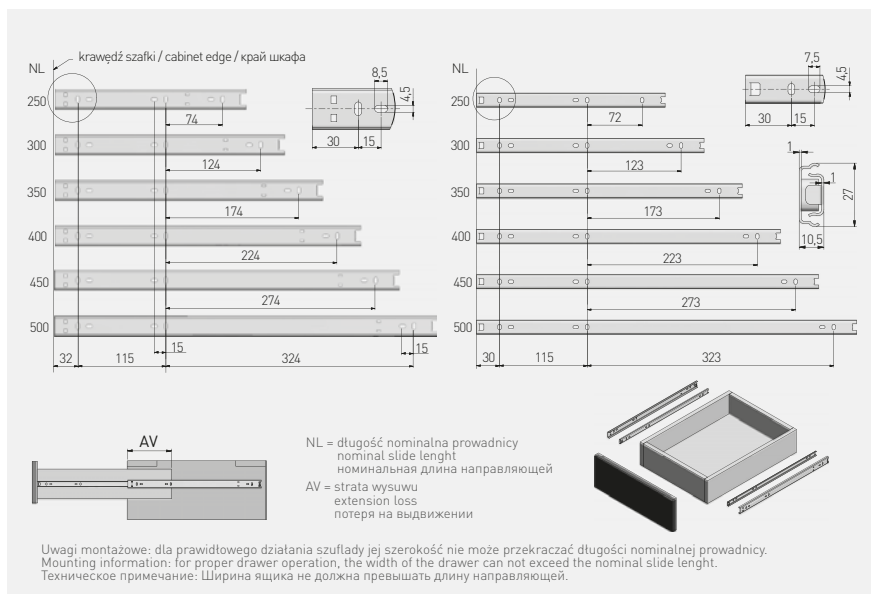



Prowadnica kulkowa H27  
Ball bearing slides H27  
Шариковая направляющая H27



	 L mm	 AV mm		 kg		
PK-0H27-3000	300	109	niepełny partial неполное	15		stal galvanized гальваника steel сталь
PK-0H27-3500	350	124				
PK-0H27-4000	400	134				
PK-0H27-4500	450	149				
PK-0H27-5000	500	184				



Prowadnica kulkowa do półki pod klawiaturę H27  
 Ball bearing slides for keyboard H27  
 Шариковая направляющая для полки под клавиатуру H27

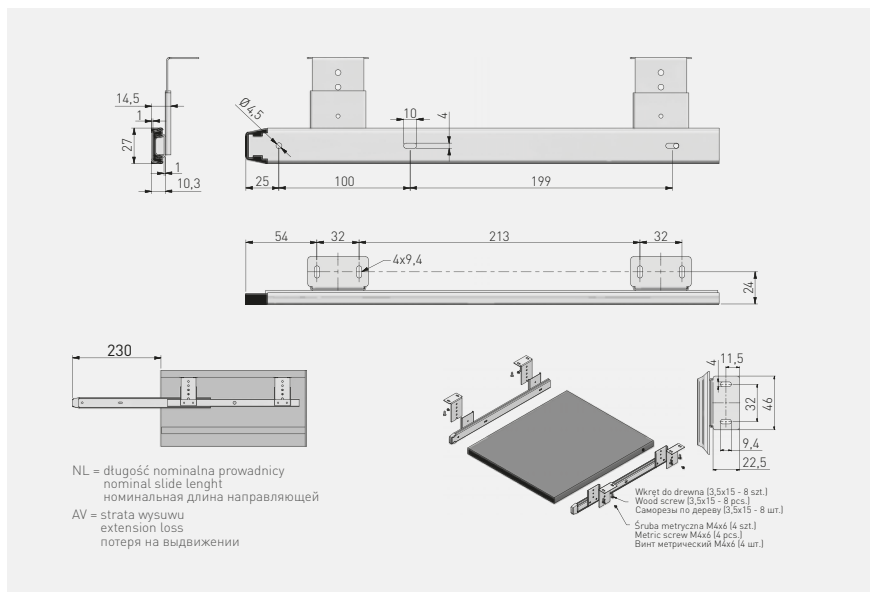

					
PK-0-000-027	360	niepety partial неполное	10	ocynk galvanized гальванка	stal steel сталь



Prowadnica kulkowa H17  
Ball bearing slide H17  
Шариковая направляющая H17

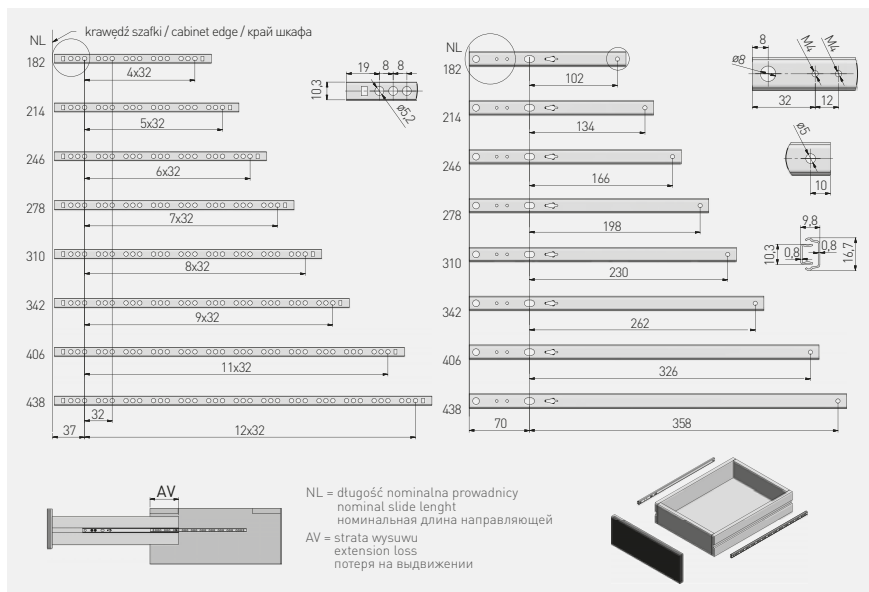

Icon	L (mm)	AV (mm)	Icon	Icon	Icon	Icon
	182	62				
PK-0H17182XP	182	62	niepełny partial неполное	8	ocynk galvanized гальваника	stal steel сталь
PK-0H17214XP	214	77				
PK-0H17246XP	246	77				
PK-0H17278XP	278	77				
PK-0H17310XP	310	100				
PK-0H17342XP	342	100				
PK-0H17406XP	406	100				
PK-0H17438XP	438	100				



Prowadnica Metalbox MP  
 Slides Metalbox MP  
 Направляющая Metalbox MP



Wymiary montażowe mocowania frontu:  
 Front mounting dimensions:  
 Установочные размеры крепления фасада:

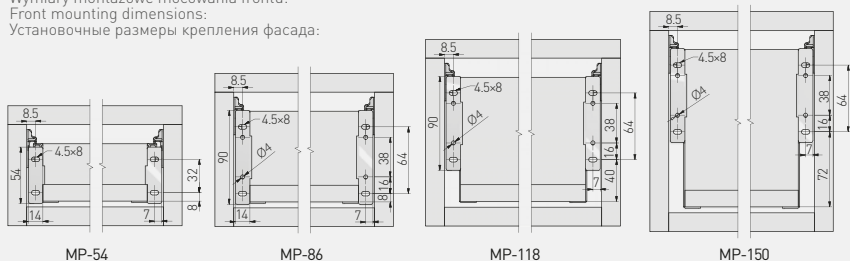

MP-54









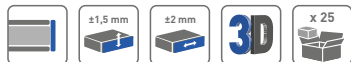
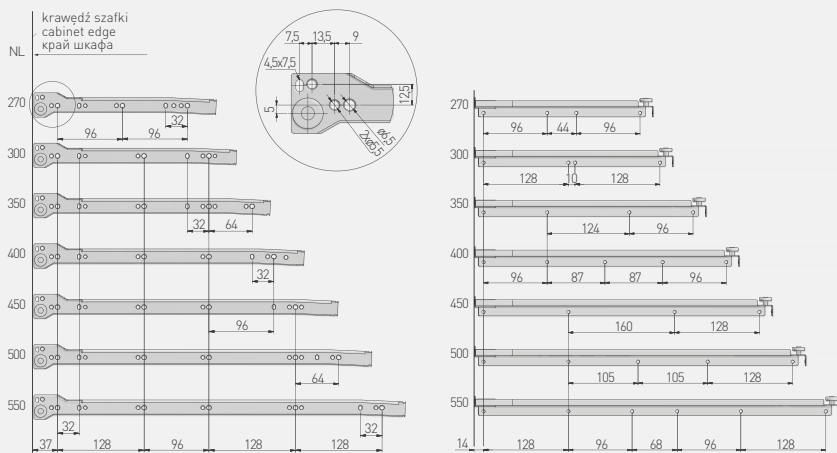

MP-86

MP-118

MP-150







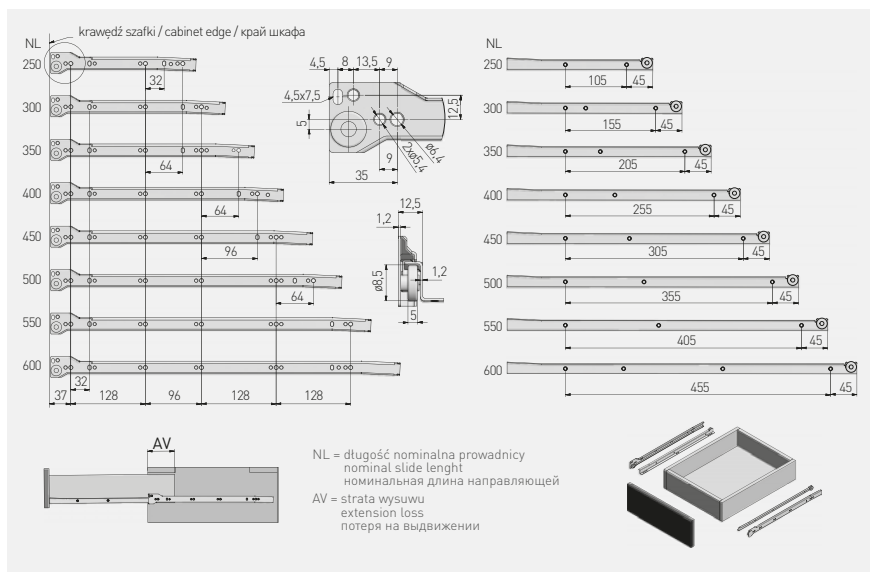

Rozstaw otworów montażowych  
 Mounting dimensions  
 Монтажные отверстия



		 H mm	 L mm	 AV mm		 kg				
MP-054350-10	54	350	88	niepełny partial неполное	25	lakier lacquer лак	biały white белый			
MP-054400-10		400	98							
MP-054450-10		450	98							
MP-054500-10		500	98							
MP-054450-80		450	98							
MP-054500-80		500	98							
MP-086270-10	86	270	88				stal steel сталь			
MP-086300-10		300	88							
MP-086350-10		350	88							
MP-086400-10		400	98							
MP-086450-10		450	98							
MP-086500-10		500	98							
MP-086550-10		550	118							
MP-086270-80		270	88							
MP-086300-80		300	88							
MP-086350-80		350	88							
MP-086400-80		400	98							
MP-086450-80		450	98							
MP-086500-80		500	98							
MP-086550-80		550	118							
MP-118350-10		118	350							88
MP-118400-10			400							98
MP-118450-10			450							98
MP-118500-10			500							98
MP-150270-10	150	270	88							
MP-150300-10		300	88							
MP-150350-10		350	88							
MP-150400-10		400	98							
MP-150450-10		450	98							
MP-150500-10		500	98							
MP-150550-10		550	118							
MP-150270-80		270	88							
MP-150300-80		300	88							
MP-150350-80		350	88							
MP-150400-80		400	98							
MP-150450-80		450	98							
MP-150500-80		500	98							
MP-150550-80		550	118							

Prowadnica rolkowa SP  
Euro roller slides  
Роликовая направляющая SP



		 L mm	 AV mm		 kg			
PR-SP-250-10		250	85	niepełny partial неполное	25	biały white белый	lakier lacquer лак	0B - stal , rolka - POM 0B - steel, roll - POM 0B - сталь, ролик - POM
PR-SP-300-10		300	85					
PR-SP-350-10		350	85					
PR-SP-400-10		400	95					
PR-SP-450-10		450	95					
PR-SP-500-10		500	95					
PR-SP-550-10		550	115					
PR-SP-600-10		600	115					



Prowadnica rolkowa 0B  
Euro roller slides 0B  
Роликовая направляющая 0B

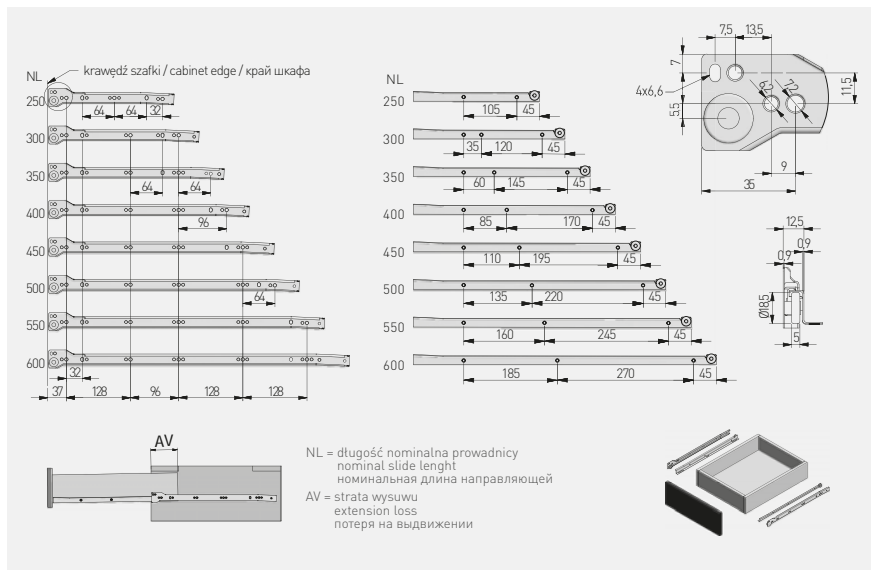





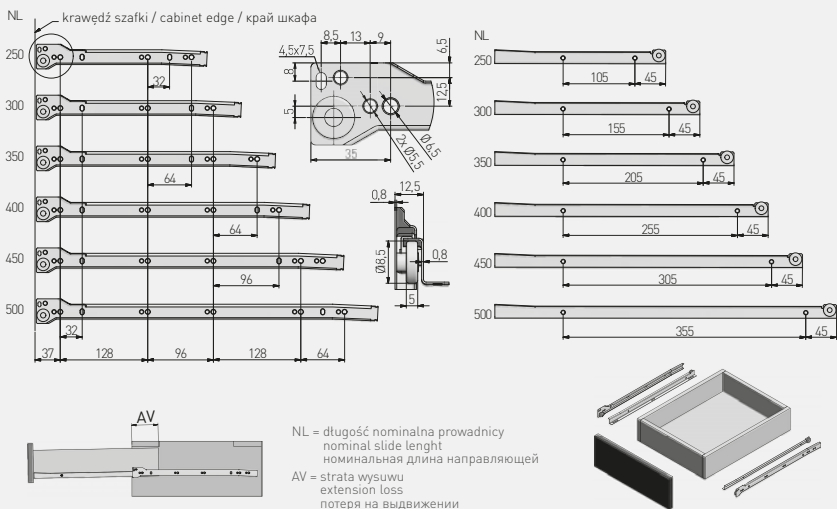

		L mm	AV mm	kg				L mm	AV mm	kg	
PR-0B-250-10		250	100				PR-0B-250-30	250	100		
PR-0B-300-10		300	100				PR-0B-300-30	300	100		
PR-0B-350-10		350	100				PR-0B-350-30	350	100		
PR-0B-400-10		400	100				PR-0B-400-30	400	100		
PR-0B-450-10		450	100				PR-0B-450-30	450	100		
PR-0B-500-10		500	110				PR-0B-500-30	500	110		
PR-0B-550-10		550	115				PR-0B-550-30	550	115		
PR-0B-600-10		600	125				PR-0B-600-30	600	125		



Prowadnica rolkowa OC  
Euro roller slides OC  
Роликовая направляющая OC





		 L mm	 AV mm		 kg		
PR-OC-250-10		250	85	niepełny partial неполное	15	biały	stal steel сталь
PR-OC-300-10		300	85				
PR-OC-350-10		350	95				
PR-OC-400-10		400	95				
PR-OC-450-10		450	95				



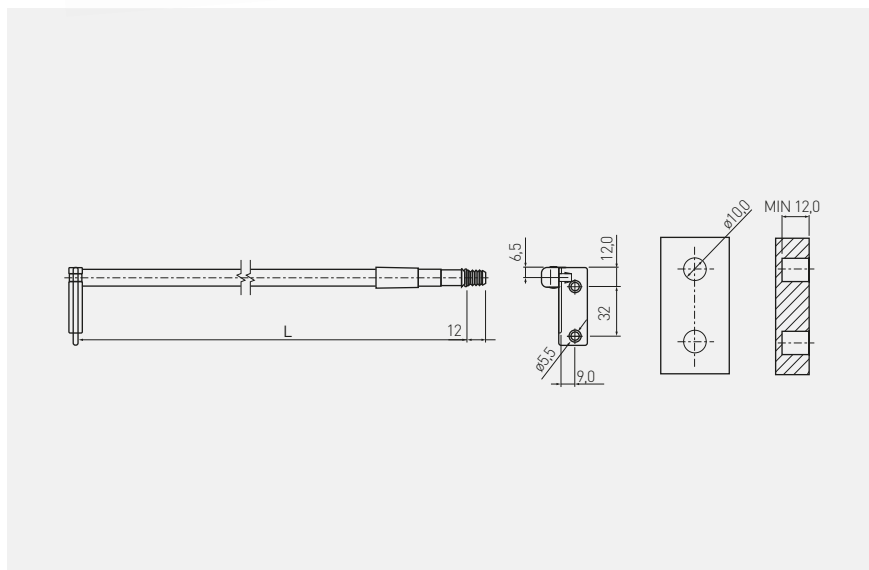

Reling z uchwytem ścianki tylnej lewy / prawy  
 Rail with back panel connector left / right  
 Релинг с ручкой задней стенки левый / правый



	$N_L$ [mm]	$L_{min} / L_{max}$ [mm]	
RS-SZ-400-10	400	393 / 404	biały / white / белый
RS-SZ-450-10	450	443 / 454	biały / white / белый
RS-SZ-450-80	450	443 / 454	srebrny / silver / серебро
RS-SZ-500-10	500	493 / 504	biały / white / белый
RS-SZ-500-80	500	493 / 504	srebrny / silver / серебро

NL - długość nominalna relingu  
 NL - rails nominal length  
 NL - номинальная длина релинга  
 $L$  - długość rzeczywista relingu mieszcząca się w przedziale ( $L_{min}; L_{max}$ )  
 $L$  - actual length  
 $L$  - фактическая длина релинга в пределах ( $L_{мин}; L_{макс}$ )

Spowalniacz do prowadnic rolkowych oraz szuflad typu Metalbox 350 - 550 mm  
 Soft closing device for Metalbox 350 - 550 mm  
 Доводчик для роликовых направляющих и Металбоксов 350 - 550 мм

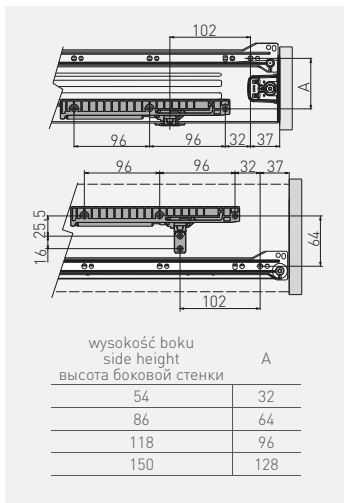

AM-MBSOFT-P2	25	szary gray серый	tworzywo plastic пластмасса

Rolka stabilizująca  
 Drawer Stabilizer  
 Стабилизирующий механизм

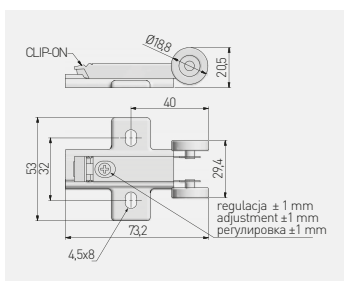

Do szuflad skrzyniowych wyposażonych w prowadnice Push to open  
 For drawers with Push to open  
 Для ящиков с направляющими push to open



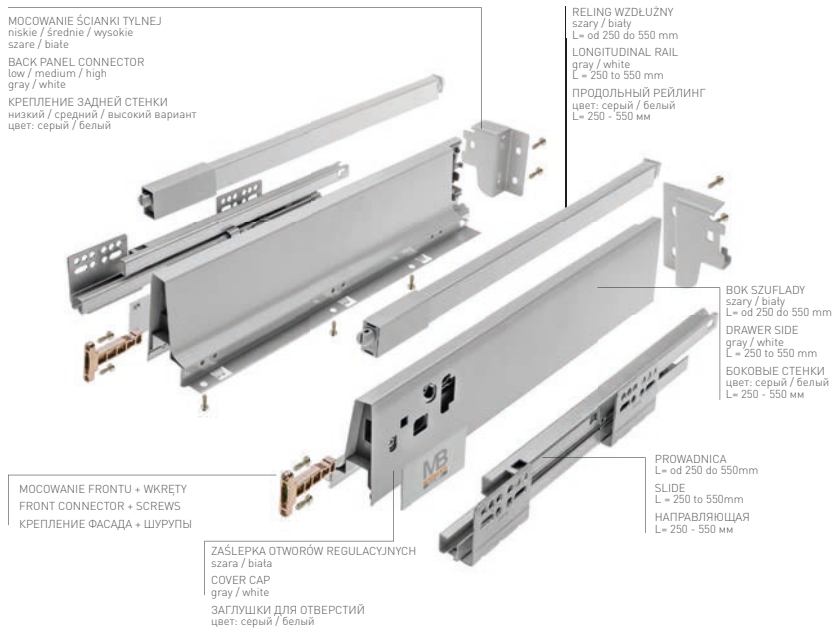

PB-D-P20STAB	nikiel / nickel / никель	stal / steel / сталь

Modern Box Square – skład zestawu  
 Modern Box Square – set  
 Modern Box Square – комплектация

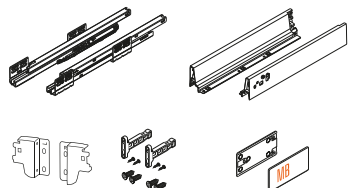







**Modern Box Square**  
 Komplet szuflady niskiej „A”  
 Low drawer set „A”  
 Низкий ящик „А”

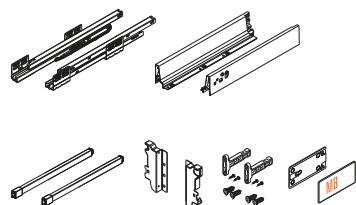

					
PB-KW-KPL300A	300	40	szary grey серый	lakier lacquer лак	stal steel сталь
PB-KW-KPL350A	350				
PB-KW-KPL400A	400				
PB-KW-KPL450A	450				
PB-KW-KPL500A	500				
PB-KW-KPL550A	550				
PB-KW-KPL250A1-50	250	50	biały white белый		
PB-KW-KPL350A1-50	350				
PB-KW-KPL400A1-50	400				
PB-KW-KPL450A1-50	450				
PB-KW-KPL500A1-50	500				
PB-KW-KPL550A1-50	550				

**Modern Box Square**  
 Komplet szuflady sredniej „B”  
 Medium drawer set „B”  
 Средний ящик „B”







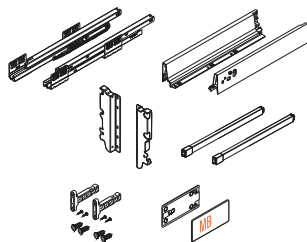

					
PB-KW-KPL250B	250	40	szary grey серый	lakier lacquer лак	stal steel сталь
PB-KW-KPL350B	350				
PB-KW-KPL400B	400				
PB-KW-KPL450B	450				
PB-KW-KPL500B	500				
PB-KW-KPL550B	550				
PB-KW-KPL350B-50	350	50	biały white белый		
PB-KW-KPL400B-50	400				
PB-KW-KPL550B-50	550				
PB-KW-KPL250B1-50	250				
PB-KW-KPL350B1-50	350				
PB-KW-KPL400B1-50	400				
PB-KW-KPL450B1-50	450				
PB-KW-KPL500B1-50	500				

## Modern Box Square

Komplet szuflady wysokiej „C”  
High drawer set „C”  
Высокий ящик „C”



	 L mm	 kg			
PB-KW-KPL250C	250	40	szary grey серый	lakier lacquer лак	stal steel сталь
PB-KW-KPL300C	300				
PB-KW-KPL350C	350				
PB-KW-KPL400C	400				
PB-KW-KPL450C	450				
PB-KW-KPL500C	500				
PB-KW-KPL550C	550	50	biały white белый		
PB-KW-KPL350C1-50	350				
PB-KW-KPL400C1-50	400				
PB-KW-KPL450C1-50	450				
PB-KW-KPL500C1-50	500				
PB-KW-KPL550C1-50	550				

## Modern Box Square

Komplet szuflady wewnętrznej wysokiej „C”  
High inner drawer set „C”  
Внутренний высокий ящик „C”

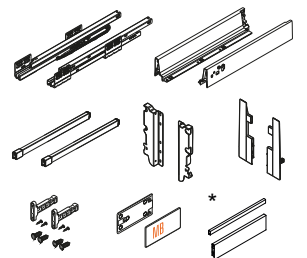

	 L mm	 kg			
PB-D-WEWKPL350C	350	40	szary grey серый	lakier lacquer лак	stal steel сталь
PB-D-WEWKPL400C	400				
PB-D-WEWKPL450C	450				
PB-D-WEWKPL500C	500				
PB-D-WEWKPL550C	550				

\*Nie wchodzi w skład zestawu:  
- PB-RP-KW1100 (reling poprzeczny)  
- PB-D-PANELWEW (panel przedni)

\*Not included in drawer set:  
- PB-RP-KW1100 (transverse rail)  
- PB-D-PANELWEW (front panel)

\*В комплект не входят:  
- PB-RP-KW1100 (поперечный рейлинг)  
- PB-D-PANELWEW (передняя панель)

Reлинг wzdużny  
Longitudinal drawer rail  
Продольный рейлинг

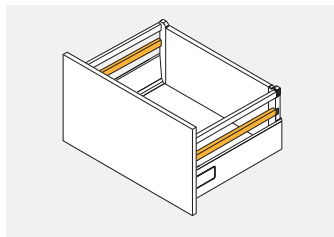

PB-D-RELKW350	350	szary grey серый	lakier lacquer лак	stal steel сталь
PB-D-RELKW400	400			
PB-D-RELKW450	450			
PB-D-RELKW500	500			
PB-D-RELKW550	550			
PB-D-RELKW350-10	350	biały white белый		
PB-D-RELKW400-10	400			
PB-D-RELKW450-10	450			
PB-D-RELKW500-10	500			
PB-D-RELKW550-10	550			



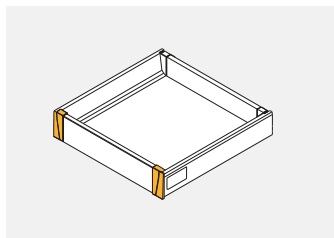

Złączka frontu wewnętrzznego, niska  
Inner front connector  
Соединитель передней панели, низкий

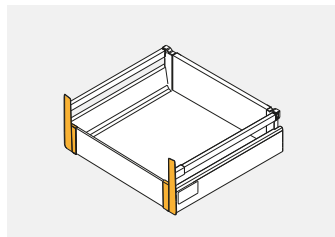

PB-D-WEWMOCA-KW	szuflada niska „A” Low drawer A Низкий ящик „А”	szary / grey / серый	tworzywo plastic пластмасса
PB-D-WEWMOCA-KW-10		biały / white / белый	

Złączka frontu wewnętrznego, średnia  
 Inner front connector  
 Соединитель передней панели, средний



			
PB-D-WEWMOCB-KW	szuflada srednia „B” medium drawer B Средний ящик „B”	szary / grey / серый	tworzywo plastic пластмасса
PB-D-WEWMOCB-KW-10		biały / white / белый	



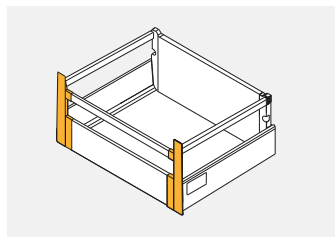

Złączka frontu wewnętrznego, wysoka  
 Inner front connector  
 Соединитель передней панели, высокий

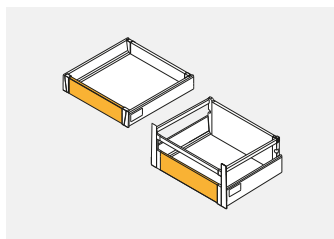
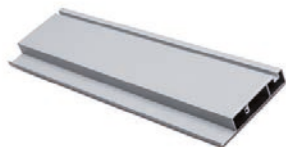

			
PB-D-WEWMOCC-KW	szuflada wysoka „C” high drawer C Высокий ящик „C”	szary / grey / серый	tworzywo plastic пластмасса
PB-D-WEWMOCC-KW-10		biały / white / белый	

Panel przedni frontu wewnętrznego  
Front panel  
Передняя панель внутреннего ящика



	 L mm		
PB-D-PANELWEW	1100	szary / grey / серый	aluminium aluminium алюминий
PB-D-PANELWEW-10		biały / white / белый	

Reлинг poprzeczny  
Transverse rail  
Поперечный рейлинг

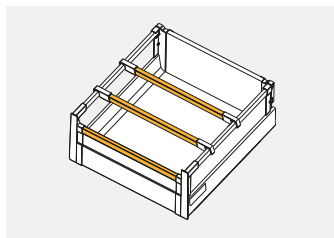

	 L mm		
PB-RP-KW1100	1100	szary / grey / серый	stal steel сталь
PB-RP-KW1100-10		biały / white / белый	



Łącznik relingu poprzecznego  
 Transverse rail connector  
 Соединитель поперечного рейлинга

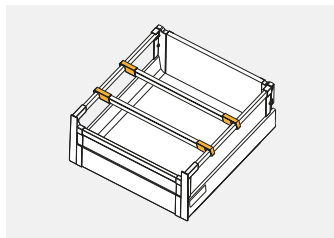

PB-D-ZR-KW-00	1 kpl. = 2 szt. 1 set = 2 pcs.	szary / grey / серый	tworzywo plastic пластмасса
PB-D-ZR-KW-10	1 комп. = 2 шт.	biały / white / белый	

Listwa poprzeczna  
 Transverse bar  
 Поперечная планка

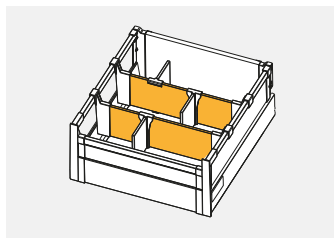

PB-D-LIS1100-KW	1100	szary / grey / серый	aluminium aluminium алюминий
PB-D-LIS1100-KW-10		biały / white / белый	

Złączka do listwy poprzecznej  
 Transverse bar connector  
 Соединитель поперечной планки

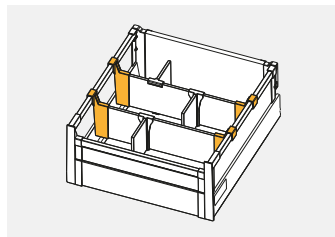

PB-D-CONREL-KW	1 kpl. = 2 szt. 1 set = 2 pcs.	szary / grey / серый	tworzywo plastic пластмасса
PB-D-CONREL-KW-10	1 комп. = 2 шт.	biały / white / белый	

Przegroda do listwy poprzecznej  
 Transverse bar divider  
 Перегородка для поперечной планки

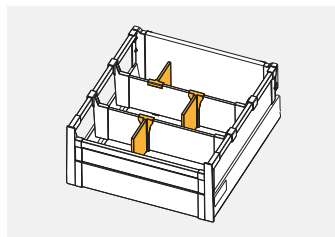

PB-D-PRZEGLP-KW	1 szt.	szary / grey / серый	tworzywo plastic пластмасса
PB-D-PRZEGLP-KW-10	1 pce. 1 шт.	biały / white / белый	

Mocowanie relingu do podwyższonej ścianki tylnej  
 Back panel connector for rails, additional  
 Соединитель задней стенки для рейлингов, дополнительная



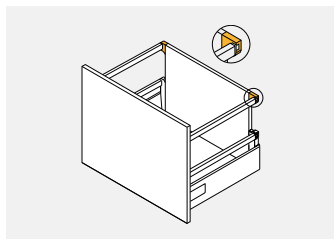

NEW

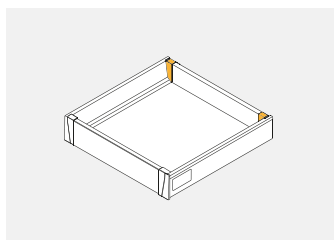

			
PB-D-D2R0-01	1 kpl. = 2 szt	biały / white / белый	tworzywo plastic пластмасса

Złączka ścianki tylnej niska  
 Back panel connector low  
 Держатель задней стенки, низкий



			
PB-D-N2R0-00	kpl.=L+P Set = L+R	szary / grey / серый	stal steel
PB-D-N2R0-01	комп.=Л+П	biały / white / белый	stal steel

Złączka ścianki tylnej średnia  
 Back panel connector medium  
 Держатель задней стенки, средний

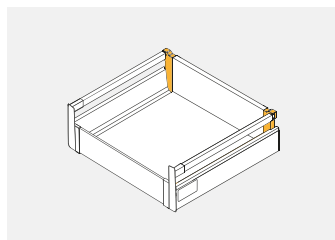

PB-D-S2R0-00	kpl.=L+P Set = L+R комп.=Л+П	szary / grey / серый	stal steel сталь
PB-D-S2R0-01		biały / white / белый	

Złączka ścianki tylnej wysoka  
 Back panel connector high  
 Держатель задней стенки, высокий

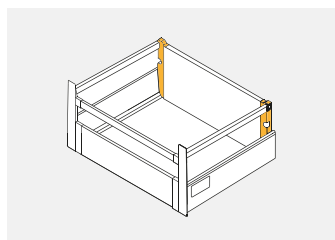

PB-D-W2R0-00	kpl.=L+P Set = L+R комп.=Л+П	szary / grey / серый	stal steel сталь
PB-D-W2R0-01		biały / white / белый	

Mocowanie do relingów  
 Rails mounting  
 Держатель рейлинга



			
PB-D-MHG04-KW	1 szt. 1 pc. 1 шт.	szary gray серый	tworzywo plastic пластмасса

Matryca do relingów  
 Marking gauge for rails  
 Матрица для рейлингов



			
PB-D-MATRYCA	kpl.=1 szt. set = 1pc. 1 комп.= 1 шт.	szary gray серый	tworzywo plastic пластмасса

Znacznik do frontów  
 Marking gauge for drawer front  
 Маркер фасада



			
PB-D-ZNACZ-0	kpl.=2 szt. set = 2 pcs. 1 комп.= 2 шт.	szary gray серый	ZnAl

Modern Box – skład zestawu  
 Modern Box – set  
 Modern Box – комплектация

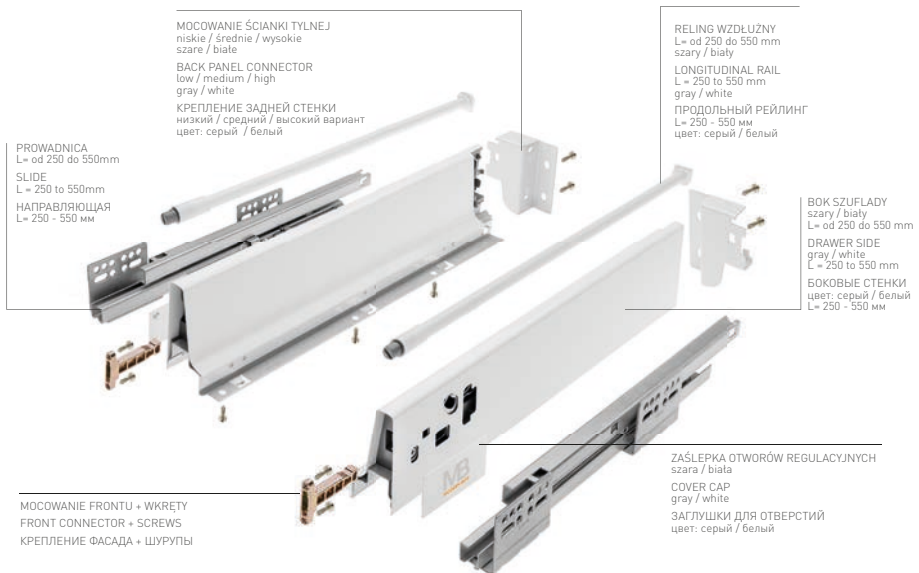







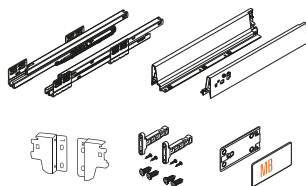

## Modern Box

MB - komplet szuflady niskiej „A”

Low drawer set A

Низкий ящик „А”



		 L mm		 Kg			
PB-D-KPL250A	250	soft close	40	szary grey серый	lakier lacquer лак	stal steel сталь	
PB-D-KPL300A	300						
PB-D-KPL350A	350						
PB-D-KPL400A	400						
PB-D-KPL450A	450						
PB-D-KPL500A	500						
PB-D-KPL550A	550						
PB-D-KPL250A1	250	push to open		szary grey серый			
PB-D-KPL300A1	300						
PB-D-KPL350A1	350						
PB-D-KPL400A1	400						
PB-D-KPL450A1	450						
PB-D-KPL500A1	500						
PB-D-KPL550A1	550						
PB-D-P20250A	250						
PB-D-P20300A	300						
PB-D-P20350A	350						
PB-D-P20400A	400						
PB-D-P20450A	450						
PB-D-P20500A	500						
PB-D-P20550A	550						



### Modern Box

MB - komplet szuflady sredniej „B”  
 Medium drawer set B  
 Средний ящик „B”



PB-D-KPL300B	300	soft close	40	szary grey серый	lakier lacquer лак	stal steel сталь
PB-D-KPL350B	350					
PB-D-KPL400B	400					
PB-D-KPL450B	450					
PB-D-KPL500B	500					
PB-D-KPL550B	550					

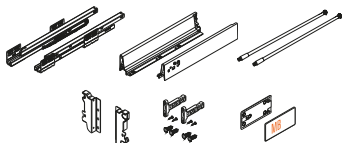

### Modern Box

MB - komplet szuflady wysokiej „C”  
 High drawer set „C”  
 Высокий ящик „C”



PB-D-KPL250C	250	soft close	40	szary grey серый	lakier lacquer лак	stal steel сталь
PB-D-KPL300C	300					
PB-D-KPL350C	350					
PB-D-KPL400C	400					
PB-D-KPL450C	450					
PB-D-KPL500C	500					
PB-D-KPL550C	550			szary grey серый		
PB-D-KPL250C1	250					
PB-D-KPL300C1	300					
PB-D-KPL350C1	350					
PB-D-KPL400C1	400					
PB-D-KPL450C1	450					
PB-D-KPL500C1	500	push to open				
PB-D-KPL550C1	550					
PB-D-P20250C	250					
PB-D-P20300C	300					
PB-D-P20350C	350					
PB-D-P20400C	400					
PB-D-P20450C	450					
PB-D-P20500C	500					
PB-D-P20550C	550					

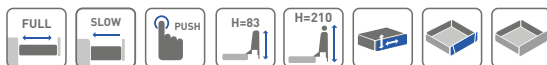
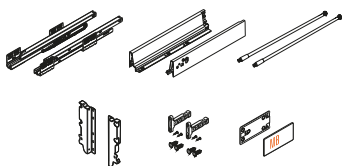



Reling wzdużny  
Longitudinal rail  
Продольный рейлинг

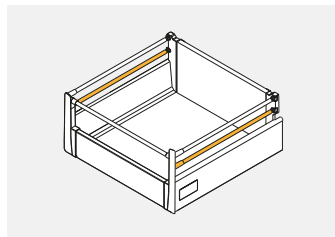

PB-D-REL2500	250	szary grey серый	stal steel сталь
PB-D-REL3000	300		
PB-D-REL3500	350		
PB-D-REL4000	400		
PB-D-REL4500	450		
PB-D-REL5000	500		
PB-D-REL5500	550	biały white белый	
PB-D-REL450-10	450		
PB-D-REL500-10	500		
PB-D-REL550-10	550		

Złączka frontu wewnętrzznego, niska  
Inner front connector low  
Соединитель передней панели, низкий

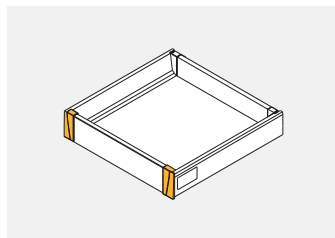

PB-D-WEWMOCA	szuflada niska „A” low drawer A низкий ящик „A”	szary / grey / серый	tworzywo plastic пластмасса
PB-D-WEWMOCA1		biały / white / белый	

Złączka frontu wewnętrznego średnia  
 Inner drawer connector medium  
 Соединитель передней панели, средний

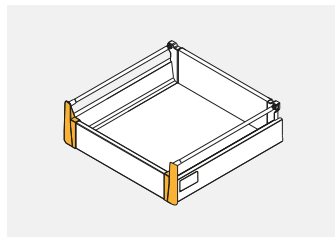

PB-D-WEWMOCB	szuflada srednia „B” medium drawer B средний ящик „B”	szary / grey / серый	tworzywo plastic пластмасса
PB-D-WEWMOCB1		biały / white / белый	

Złączka frontu wewnętrznego, wysoka, do 1 kompletu relingów  
 Inner drawer connector high, for 1 set of rails  
 Соединитель передней панели, высокий, для 1 комплекта рейлингов

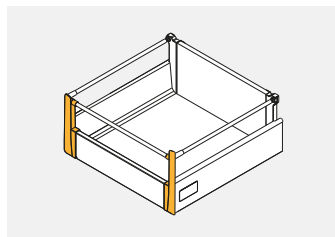

PB-D-WEWSZKLC	szuflada wysoka „C” 1 reling high drawer C 1 rail высокий ящик „C”, рейлинг -1 шт.	szary / grey / серый	tworzywo plastic пластмасса
PB-D-WEWSZKLC-10		biały / white / белый	

Złączka frontu wewnętrznego, wysoka, do 2 kompletów relingów  
 Inner drawer front connector, high, for 2 sets of rails  
 Соединитель передней панели, высокий, для 2 комплектов рейлингов

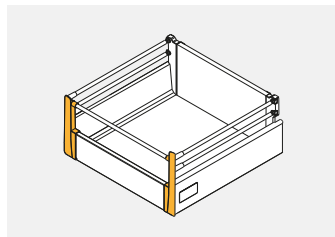
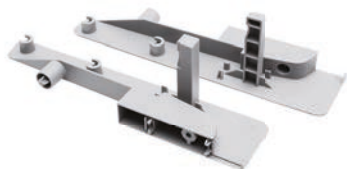

PB-D-WEWMOCC	szuflada wysoka „C” 2 relingi high drawer C 2 rails Высокий ящик „C”, рейлинг -2 шт.	szary / grey / серый	tworzywo plastic пластмасса
PB-D-WEWMOCC1		biały / white / белый	



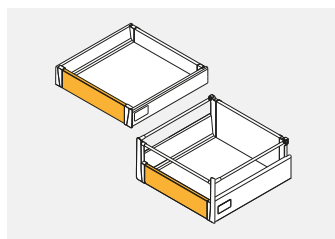
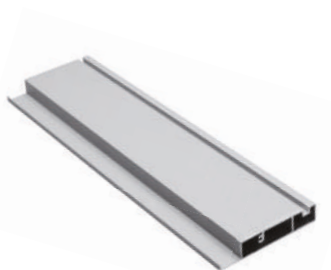

Panel przedni frontu wewnętrznego  
 Front panel  
 Передняя панель

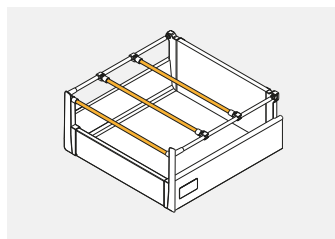

PB-D-PANELWEW	1100	szary / grey / серый	aluminium aluminium алюминий
PB-D-PANELWEW-10		biały / white / белый	



Reling poprzeczny  
Transverse rail  
Поперечный рейлинг

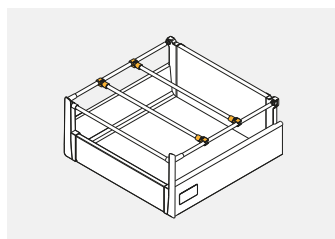

			
PB-D-RP-1100	1100	szary / grey / серый	stal steel
PB-D-RP-1100-10		biały / white / белый	stal steel

Łącznik relingu poprzecznego  
Transverse rail connector  
Соединитель поперечного рейлинга



			
PB-D-ZR-00-0	1 kpl = 2 szt. 1 set = 2 pcs. 1 комп. = 2 шт.	szary / grey / серый	tworzywo plastic
PB-D-ZR-00-10		biały / white / белый	plastmasa plastic

Uchwyt do szuflady wewnętrznej  
 Inner drawer handle  
 Ручка для внутреннего ящика

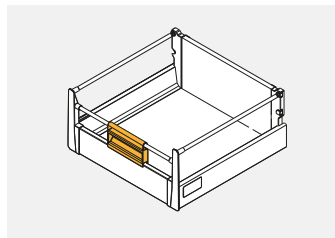

PB-D-UCHWEW	szary / grey / серый	tworzywo plastic
PB-D-UCHWEW-10	biały / white / белый	пластмасса

Łącznik krzyżowy do relingu  
 Cross rail connector  
 Крестообразный соединитель рейлингов

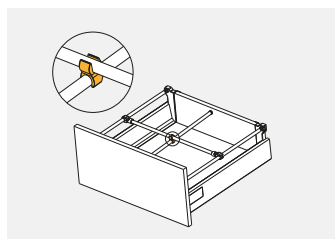

PB-D-LR-00-0	szary / grey / серый	tworzywo plastic
PB-D-LR-00-10	biały / white / белый	пластмасса

Zaślepka do relingu poprzecznego  
End cap for transverse rail  
Заглушка для поперечного рейлинга

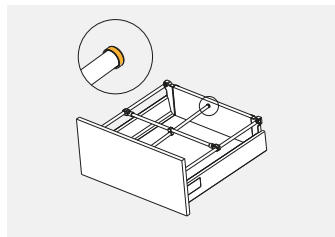

PB-D-RELCOV	szary / grey / серый	tworzywo plastic пластмасса
PB-D-RELCOV-10	biały / white / белый	

Listwa poprzeczna  
Transverse bar  
Поперечная планка

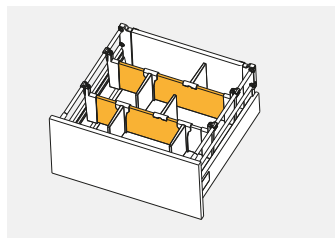

PB-D-LIS1100	1100	szary / grey / серый	aluminium aluminium алюминий
PB-D-LIS1100-10		biały / white / белый	

Złączka listwy poprzecznej do relingu  
 Connector for transverse rail and bar  
 Соединитель поперечных планок и рейлингов

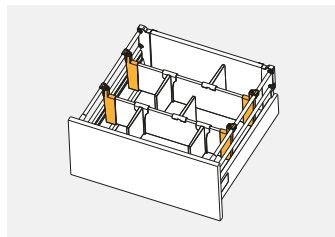

PB-D-CONREL	1 kpl. = 2 szt. 1 set = 2 pcs. 1 комп. = 2 шт.	szary / grey / серый	tworzywo plastic пластмасса
PB-D-CONREL-10		biały / white / белый	

Złączka listwy poprzecznej do boku perforowanego  
 Transverse bar connector for perforated sides  
 Соединитель поперечных планок и перфорированных боковин

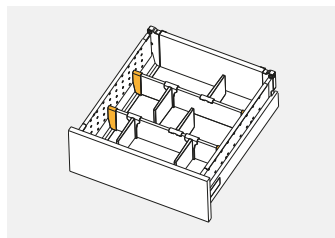

PB-D-CONBXSID	1 kpl. = 2 szt. 1 set = 2 pcs. 1 комп. = 2 шт.	szary / grey / серый	tworzywo plastic пластмасса
PB-D-CONBXSIDE-10		biały / white / белый	

Przegroda listwy poprzecznej  
 Transverse bar divider  
 Перегородка для поперечной планки

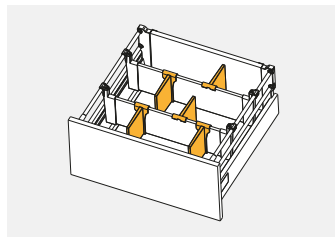

PB-D-PRZEGLP	szary / grey / серый	tworzywo plastic пластмасса
PB-D-PRZEGLP-10	biały / white / белый	

Bok perforowany do szuflady średniej  
 Perforated side for medium drawer  
 Перфорированная боковина, низкая

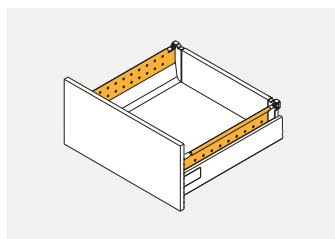





PB-D-BXSIDE45B	450	szary / grey / серый	stal steel
PB-D-BXSIDE45B-10		biały / white / белый	
PB-D-BXSIDE50B	500	szary / grey / серый	
PB-D-BXSIDE50B-10		biały / white / белый	

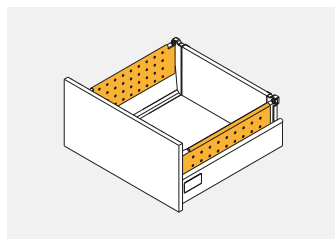





Bok perforowany do szuflady wysokiej  
 Perforated side for high drawer  
 Перфорированная боковина, высокая

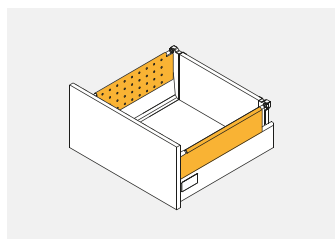

	 mm		
PB-D-BXSIDE45C	450	szary / grey / серый	stal steel сталь
PB-D-BXSIDE45C-10		biały / white / белый	
PB-D-BXSIDE50C	500	szary / grey / серый	
PB-D-BXSIDE50C-10		biały / white / белый	





Podwójny bok perforowany do szuflady wysokiej  
 Double perforated side for high drawer  
 Боковая стенка для высокого ящика, двойная, перфорированная

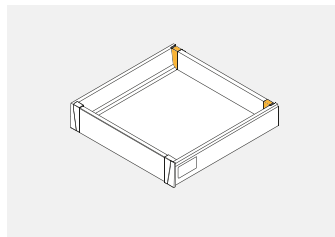

	 mm		
PB-D-DBOX450C	450	szary grey серый	stal steel сталь
PB-D-DBOX500C	500		





Złączka ścianki tylnej niska  
 Back panel connector low  
 Соединитель задней стенки, низкий

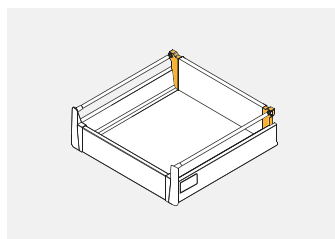

			
PB-D-N2R0-00	kpl.=L+P Set = L+R	szary / grey / серый	stal steel
PB-D-N2R0-01	комп.=Л+П	biały / white / белый	сталь

Złączka ścianki tylnej średnia  
 Back panel connector medium  
 Соединитель задней стенки, средний



			
PB-D-S2R0-00	kpl.=L+P Set = L+R	szary / grey / серый	stal steel
PB-D-S2R0-01	комп.=Л+П	biały / white / белый	сталь

Złączka ścianki tylnej wysoka  
 Back panel connector high  
 Соединитель задней стенки, высокий

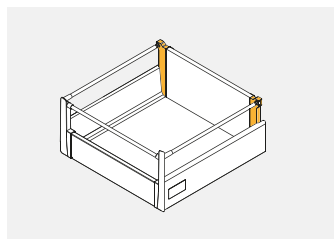

PB-D-W2R0-00	kpl.=L+P Set = L+R комп.=Л+П	szary / grey / серый	stal steel сталь
PB-D-W2R0-01		biały / white / белый	

Mocowanie relingu do podwyższonej ścianki tylnej  
 Back panel connector for rails, additional  
 Соединитель задней стенки для рейлингов, дополнительная



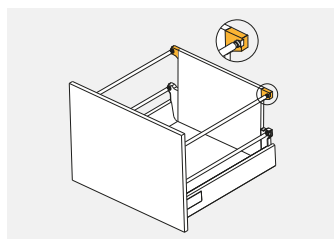

NEW



PB-D-D2R0-00	1 kpl. = 2 szt	szary / grey / серый	tworzywo plastic пластмасса
PB-D-D2R0-01		biały / white / белый	





Matryca do relingów  
 Marking gauge for rails  
 Матрица для рейлингов



			
PB-D-MATRYCA	kpl = 1 szt. set = 1 pcs. комп. = 1 шт.	szary grey серый	tworzywo plastic пластмасса





Znacznik do frontów  
 Marking gauge for drawer front  
 Маркер фасада



			
PB-D-ZNACZ-0	kpl.=2 szt. set = 2 pcs. комп. = 2 шт.	szary grey серый	ZnAl





Mocowanie do relingów  
 Rail mounting  
 Держатель рейлинга

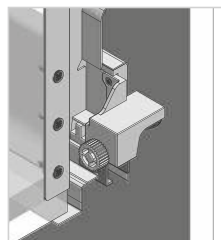

			
PB-D-MHG04	kpl.=2 szt. set = 2 pcs. комп. = 2 шт.	szary grey серый	tworzywo plastic пластмасса

Rollka stabilizująca do szuflad Push-to open  
 Drawer stabilizer for Push-to-open drawers  
 Стабилизированный механизм для ящиков



			
PB-D-MBSTAB-00	kpl.=L+P set = L+R комп.=Л+П	szary grey серый	tworzywo plastic пластмасса

Modern Box  
 Komplet szuflady piekarnikowej niskiej  
 Under oven drawer set – low  
 Ящик под духовку, низкий



					
PB-D-KPL68-450-80	450	40	szary grey серый	lakier lacquer лак	stal steel сталь
PB-D-KPL68-500-80	500				
PB-D-KPL68-450-10	450		biały white белый		
PB-D-KPL68-500-10	500				

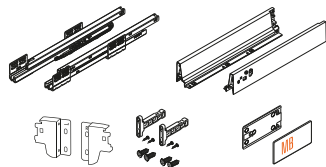

## Modern Box

Komplet szuflady narożnej niskiej  
 Corner drawer set – low  
 Угловой ящик, низкий



PB-D-COR600A	600	40	szary grey серый	lakier lacquer лак	stal steel сталь
PB-D-COR650A	650				

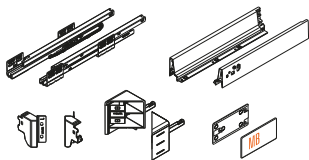

## Modern Box

Komplet szuflady narożnej wysokiej  
 Corner drawer set – high  
 Угловой ящик, высокий





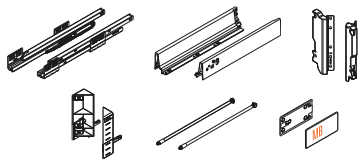



PB-D-COR600C	600	40	szary grey серый	lakier lacquer лак	stal steel сталь
PB-D-COR650C	650				

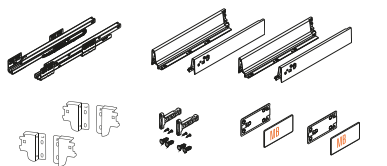

## Modern Box

Komplet szuflady zlewozmywakowej niskiej  
 Under sink drawer - sets  
 Ящик под мойку





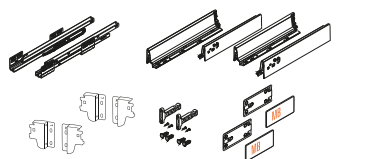

	 L mm	 kg ↓			
PB-D-ZLE-450	450	40	szary grey серый	lakier lacquer лак	stal steel сталь
PB-D-ZLE-500	500				

## Modern box

MB - komplet szuflady zlewozmywakowej „U”, niskiej  
 Under sink drawer „U”, low - sets  
 Ящик под мойку „U”, низкий - компоненты



	 L mm	 kg ↓			
PB-D-ULE-500	500	40	szary grey серый	lakier lacquer лак	stal steel сталь

AXIS

Skład zestawu  
Set  
Комплектация

bok szuflady  
szary / biały  
l= od 450 do 500 mm

drawer side  
gray / white  
l=450 to 500 mm

БОКОВИНЫ  
цвет: серый / белый  
l=450 - 500 мм

mocowanie ścianki tylnej  
niskie / średnie / wysokie  
szare / białe

back panel connector  
low / medium / high  
grey / white

крепление задней стенки  
низкое / среднее / высокое  
цвет: серый / белый

ultracienki płaszcz boczny  
ultra thin drawer sides  
ультратонкие боковины

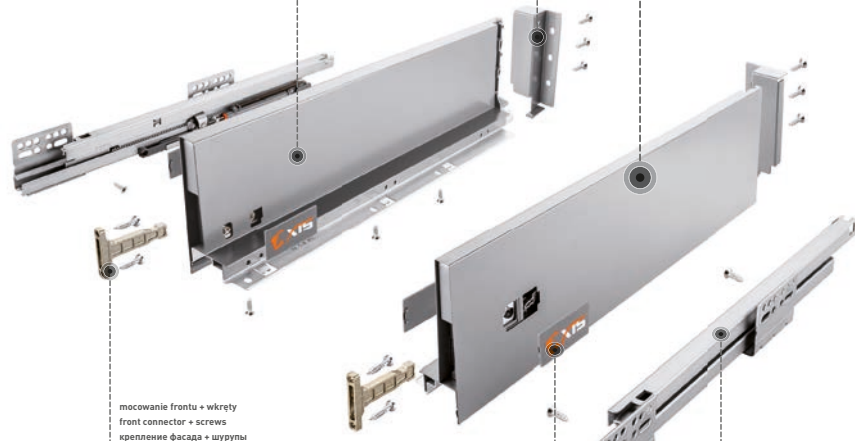

mocowanie frontu + wkrety  
front connector + screws  
крепление фасада + шурупы

zaślepka otworów regulacyjnych  
szara / biała  
cover cap  
gray / white  
заглушки для отверстий  
цвет: серый / белый

przewodnica  
l= od 450 do 500 mm  
slide  
l= 450 to 500 mm  
направляющая  
l= 450 - 500 мм



AXIS



**AXIS**

Komplet szuflady niskiej „A”  
 Low drawer set „A”  
 Низкий ящик „A”

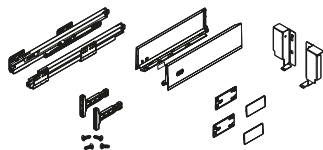

PB-AXIS-KPL450A	450	40	szary grey серый	lakier lacquer лак	stal steel сталь
PB-AXIS-KPL500A	500				
PB-AXIS-KPL450A1	450		biały white белый		
PB-AXIS-KPL500A1	500				

**AXIS**

Komplet szuflady średniej „B”  
 Medium drawer set „B”  
 Средний ящик „B”





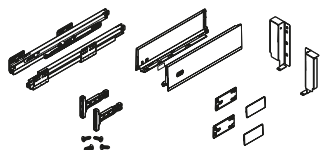





PB-AXIS-KPL450B	450	40	szary grey серый	lakier lacquer лак	stal steel сталь
PB-AXIS-KPL500B	500				
PB-AXIS-KPL450B1	450		biały white белый		
PB-AXIS-KPL500B1	500				



## AXIS

Komplet szuflady wysokiej „C”  
High drawer set „C”  
Высокий ящик „C”



	 L mm	 kg			
PB-AXIS-KPL450C	450	40			
PB-AXIS-KPL500C	500				
PB-AXIS-KPL450C1	450				
PB-AXIS-KPL500C1	500				

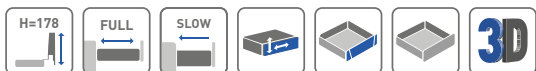
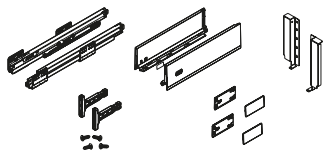

Mocowanie relingu do podwyższonej ścianki tylnej

Back panel connector for rails, additional

Соединитель задней стенки для рейлингов, дополнительная

NEW

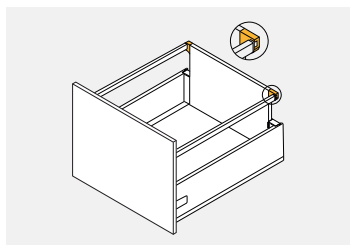

			
PB-AXIS-U2R0-00	1 kpl. = 2 szt	szary / grey / серый	tworzywo plastic пластмасса
PB-AXIS-U2R0-10		biały / white / белый	

Reлинг wzdużny  
Longitudinal rail  
Продольный рейлинг



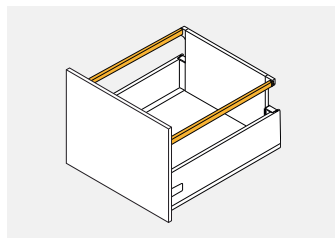

NEW

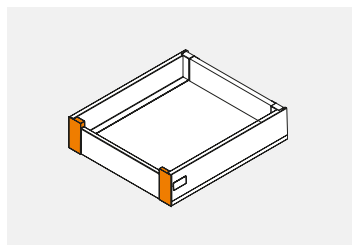

	 L mm			
PB-AXIS-RELKW450	450	szary / grey / серый	lakier lacquer лак	stal steel сталь
PB-AXIS-RELKW450-10	450	biały / white / белый		
PB-AXIS-RELKW500	500	szary / grey / серый		
PB-AXIS-RELKW500-10	500	biały / white / белый		

Złączka frontu wewnętrznego, niska  
Inner front connector low  
Соединитель передней панели, низкий



			
PB-AXIS-WEWMOCA	Szuflada niska „A” Low drawer „A” Низкий ящик „A”	szary / grey / серый	tworzywo plastic пластмасса
PB-AXIS-WEWMOCA1		biały / white / белый	

Złączka frontu wewnętrznego, średnia  
 Inner front connector medium  
 Соединитель передней панели, средний

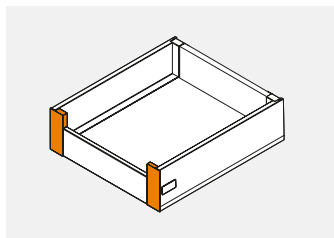

PB-AXIS-WEWMOCB	Szuflada srednia „B” Medium drawer „B”	szary / grey / серый	tworzywo plastic пластмасса
PB-AXIS-WEWMOCB1	Средний ящик „B”	biały / white / белый	

Złączka frontu wewnętrznego, wysoka  
 Inner front connector high  
 Соединитель передней панели, высокий

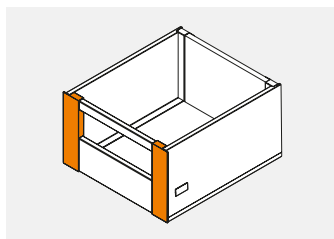

PB-AXIS-WEWMOCC	Szuflada wysoka „C” High drawer „C”	szary / grey / серый	tworzywo plastic пластмасса
PB-AXIS-WEWMOCC1	Высокий ящик „C”	biały / white / белый	

Panel przedni frontu wewnętrznego  
Front panel  
Передняя панель

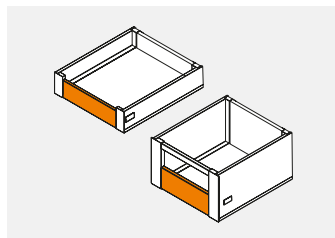

PB-AXIS-PANELWEW	1100	szary / grey / серый	aluminium aluminium алюминий
PB-AXIS-PANELWEW-10		biały / white / белый	

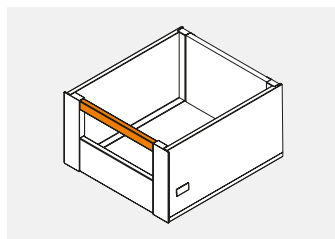

Reling poprzeczny  
Transverse rail  
Поперечный рейлинг

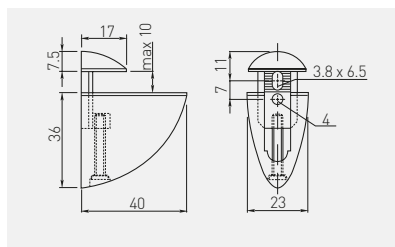

PB-AXIS-RP-1100	1054	szary / grey / серый	stal steel сталь
PB-AXIS-RP-1100-10		biały / white / белый	

## Podpórka PELIKAN mini Shelf support PELIKAN (mini) Полкодержатель PELIKAN



		
PP-XS0045-01	chrom / chrome / хром	ZnAl
PP-XS0045-02	satyna / satin / сатин	
PP-XS0045-05	aluminium / aluminium / алюминий	

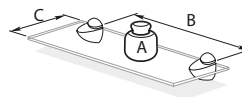

A - max 5 kg / макс. 5 кг

B - 25 cm / 25 см

C - 15 cm / 15 см

Maksymalne obciążenie zależy od ilości wsporników i materiału z jakiego wykonana jest półka.

The maximum load depends on the number of supports and material of which the self is made.

Максимальная нагрузка зависит от количества кронштейнов и материала, из которого изготовлена полка.

## Podpórka PELIKAN mała Shelf support PELIKAN (small) Полкодержатель PELIKAN

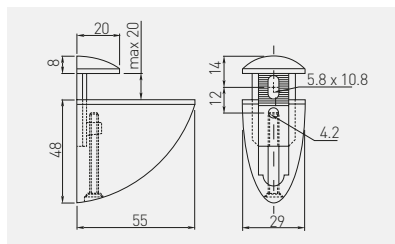

		
PP-MP0055-01	chrom / chrome / хром	ZnAl
PP-MP0055-02	satyna / satin / сатин	
PP-MP0055-05	aluminium / aluminium / алюминий	
PP-MP0055-06	stal szorstkowana / brushed steel / шлифованная сталь	
PP-MP0055-10	biały / white / белый	
PP-MP0055-20	czarny / black / чёрный	

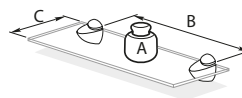

A - max 8 kg / макс. 8 кг

B - 40 cm / 40 см

C - 20 cm / 20 см

Maksymalne obciążenie zależy od ilości wsporników i materiału z jakiego wykonana jest półka.

The maximum load depends on the number of supports and material of which the self is made.

Максимальная нагрузка зависит от количества кронштейнов и материала, из которого изготовлена полка.

## Podpórka PELIKAN średnia Shelf support PELIKAN (medium) Полкодержатель PELIKAN

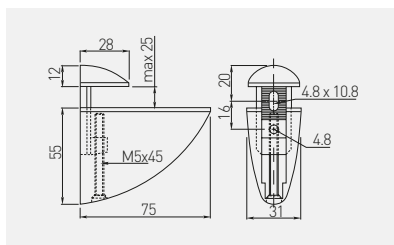

PP-SP0075-01	chrom / chrome / хром	ZnAl	
PP-SP0075-02	satyna / satin / сатин		
PP-SP0075-05	aluminium / aluminium / алюминий		
PP-SP0075-06	stal szcztokowana / brushed steel шлифованная сталь		

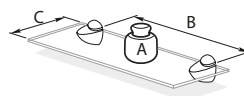

A - max 10 kg / макс. 10 кг  
B - 50 cm / 50 см  
C - 25 cm / 25 см

Maksymalne obciążenie zależy od ilości wsporników i materiału z jakiego wykonana jest półka.  
The maximum load depends on the number of supports and material of which the shelf is made.

Максимальная нагрузка зависит от количества кронштейнов и материала, из которого изготовлена полка.

## Podpórka PELIKAN duża Shelf support PELIKAN (large) Полкодержатель PELIKAN

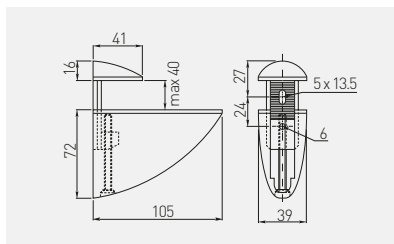

PP-DP0105-01	chrom / chrome / хром	ZnAl	
PP-DP0105-02	satyna / satin / сатин		
PP-DP0105-05	aluminium / aluminium / алюминий		
PP-DP0105-06	stal szcztokowana / brushed steel шлифованная сталь		

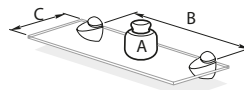

A - max 12 kg / макс. 12 кг  
B - 60 cm / 60 см  
C - 30 cm / 30 см

Maksymalne obciążenie zależy od ilości wsporników i materiału z jakiego wykonana jest półka.  
The maximum load depends on the number of supports and material of which the shelf is made.

Максимальная нагрузка зависит от количества кронштейнов и материала, из которого изготовлена полка.

## Podpórka GS01 Shelf support GS01 Полкодержатель GS01

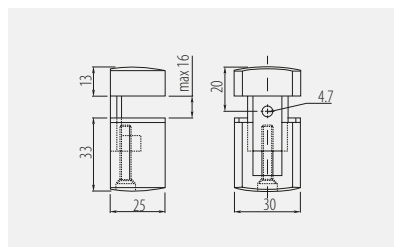

PP-00GS01-01	chrom / chrome / хром	ZnAl
PP-00GS01-02	satyna / satin / сатин	
PP-00GS01-05	aluminium / aluminium / алюминий	

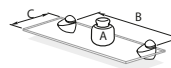

A - max 3 kg / макс. 3 кг

B - 25 cm / см

C - 15 cm / см

Maksymalne obciążenie zależy od ilości wsporników i materiału z jakiego wykonana jest półka.

The maximum load depends on the number of supports and material of which the shelf is made.

Максимальная нагрузка зависит от количества кронштейнов и материала, из которого изготовлена полка.

## Podpórka GS02 Shelf support GS02 Полкодержатель GS02

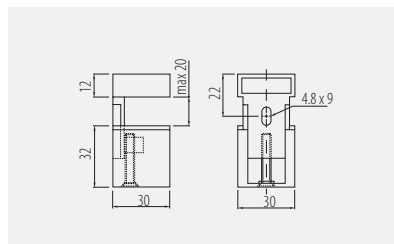

PP-00GS02-01	chrom / chrome / хром	ZnAl
PP-00GS02-02	satyna / satin / сатин	
PP-00GS02-05	aluminium / aluminium / алюминий	
PP-00GS02-06	stal szorstkowana / brushed steel / шлифованная сталь	

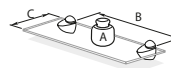

A - max 4 kg / макс. 4 кг

B - 40 cm / см

C - 20 cm / см

Maksymalne obciążenie zależy od ilości wsporników i materiału z jakiego wykonana jest półka.

The maximum load depends on the number of supports and material of which the shelf is made.

Максимальная нагрузка зависит от количества кронштейнов и материала, из которого изготовлена полка.



## Podpórka GS03

### Shelf support GS03

### Полкодержатель GS03

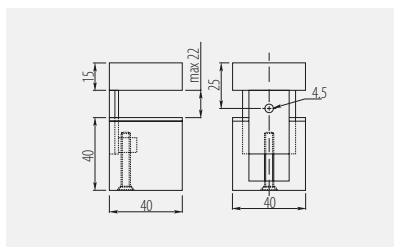

PP-00GS03-01	chrom / chrome / хром	ZnAl
PP-00GS03-02	satyna / satin / сатин	
PP-00GS03-05	aluminium / aluminium / алюминий	
PP-00GS03-06	stal szorstkowana / brushed steel / шлифованная сталь	

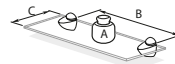

A - max 6 kg / макс. 6 кг  
B - 50 cm / см  
C - 25 cm / см

Maksymalne obciążenie zależy od ilości wsporników i materiału z jakiego wykonana jest półka.  
The maximum load depends on the number of supports and material of which the self is made.

Максимальная нагрузка зависит от количества кронштейнов и материала, из которого изготовлена полка.

## Podpórka GS04

### Shelf support GS04

### Полкодержатель GS04

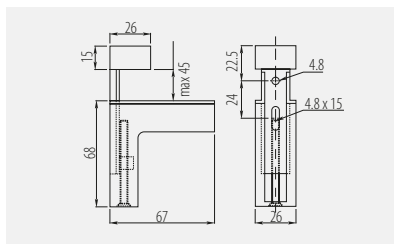

PP-00GS04-01	chrom / chrome / хром	ZnAl
PP-00GS04-02	satyna / satin / сатин	
PP-00GS04-05	aluminium / aluminium / алюминий	
PP-00GS04-06	stal szorstkowana / brushed steel / шлифованная сталь	

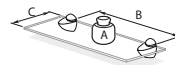

A - max 10 kg / макс. 10 кг  
B - 60 cm / см  
C - 30 cm / см

Maksymalne obciążenie zależy od ilości wsporników i materiału z jakiego wykonana jest półka.  
The maximum load depends on the number of supports and material of which the self is made.

Максимальная нагрузка зависит от количества кронштейнов и материала, из которого изготовлена полка.

Podpórka A48 mocowana na wkręt  
Shelf support A48 screw mounted  
Полкодержатель A48 монтаж на винт

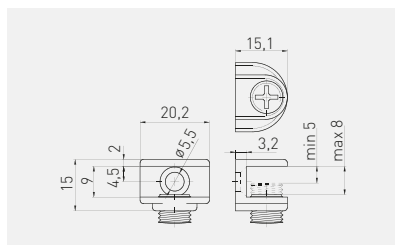

PP-GL-A48-01

chrom / chrome / хром

ZnAl



Podpórka B48 mocowana na wcisk  
Shelf support B48 plug in  
Полкодержатель B48 вставной

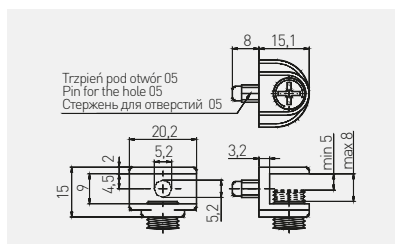

PP-GL-B48-01

chrom / chrome / хром

ZnAl



Podpórka CGP mocowana na wkręt  
Shelf support CGP screw mounted  
Полкодержатель CGP монтаж на винт

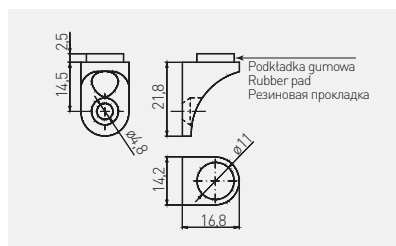

		
PP-GL-CGP-01	chrom / chrome / хром	ZnAl



Podpórka E410 mocowana na wcisk  
Shelf support E410 plug in  
Полкодержатель E410 вставной

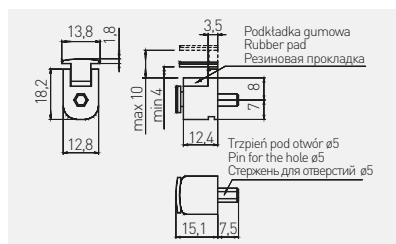

		
PP-GL-E410-01	chrom / chrome / хром	ZnAl



Podpórka F46 mocowana na wcisk  
Shelf support F46 plug in  
Полкодержатель F46 вставной

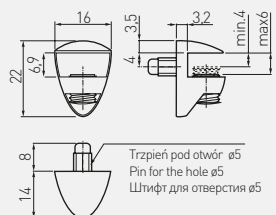

PP-GL-F46B-01

chrom / chrome / хром

ZnAl



Podpórka SL3  
Shelf support SL3  
Полкодержатель SL3

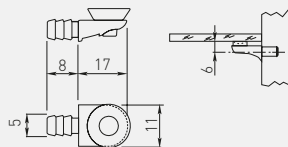

PP-S0L003-01

chrom / chrome / хром

ZnAl, tworzywo / ZnAl, plastic / ZnAl, пластмасса



Podpórka SL12  
Shelf support SL12  
Полкодержатель SL12

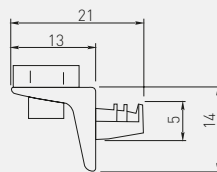

Grubość szkła max 5 mm  
Glass thickness, max. 5 mm  
Толщина стекла макс. 5 мм



PP-S0L012-01



chrom / chrome / хром



ZnAl, tworzywo / ZnAl, plastic / ZnAl, пластмасса



Podpórka HS0  
Shelf support HS0  
Полкодержатель HS0

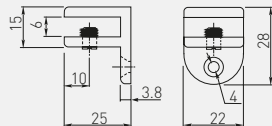

Grubość szkła max 5 mm  
Glass thickness, max. 5 mm  
Толщина стекла макс. 5 мм



PP-HS0006-01



chrom / chrome / хром



ZnAl



Podpórka HS2  
Shelf support HS2  
Полкодержатель HS2

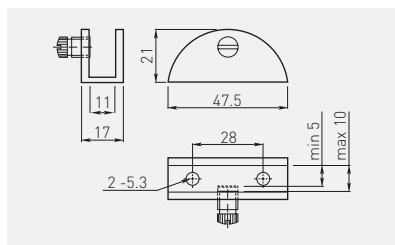

PP-HS2710-01

chrom / chrome / хром

ZnAl



Podpórka J63  
Shelf support J63  
Полкодержатель J63

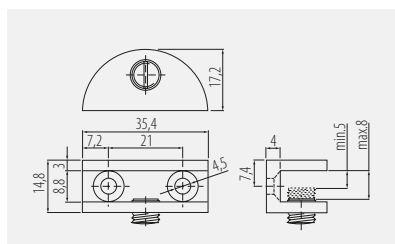

MC-J63-01

chrom / chrome / хром

MC-J63-06





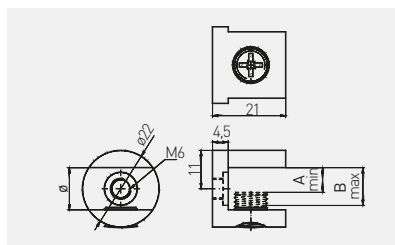

stal szcztotkowana / brushed steel / шлифованная сталь

ZnAl



Podpórka J65  
Shelf support J65  
Полкодержатель J65





	 $\varnothing$ mm	 A mm	 B mm		
MC-J65-08-01	8	4	8	chrom / chrome / хром	
MC-J65-08-05	8	4	8	stal szcztokowana / brushed steel / шлифованная сталь	ZnAl
MC-J65-10-01	10	6	10	chrom / chrome / хром	
MC-J65-10-05	10	6	10	stal szcztokowana / brushed steel / шлифованная сталь	
MC-J65-12-01	12	7	11	chrom / chrome / хром	
MC-J65-12-05	12	7	11	stal szcztokowana / brushed steel / шлифованная сталь	

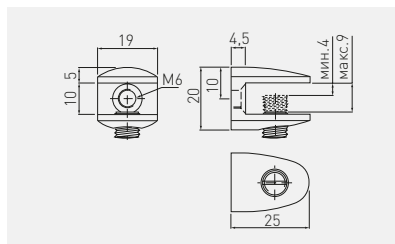

Podpórka J123  
Shelf support J123  
Полкодержатель J123



		
MC-J123-01	chrom / chrome / хром	ZnAl
MC-J123-05	stal szcztokowana / brushed steel / шлифованная сталь	



Podpórka K135  
Shelf support K135  
Полкодержатель K135

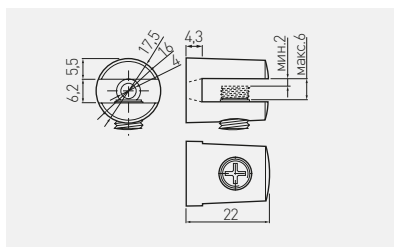

MC-K135-06-01



chrom / chrome / хром



ZnAl



Mocowanie J01  
Fixture J01  
Крепление J01

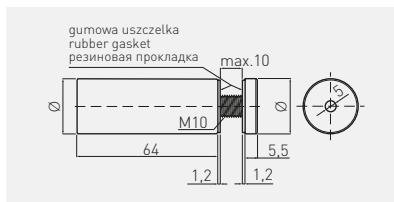

MC-J01A-12-01



mm

12

chrom / chrome / хром

MC-J01A-12-06

12

stal szcztokowana / brushed steel / шлифованная сталь

MC-J01A-16-01

16

chrom / chrome / хром

MC-J01A-16-06

16

stal szcztokowana / brushed steel / шлифованная сталь

MC-J01A-19-01

19

chrom / chrome / хром

MC-J01A-19-06

19

stal szcztokowana / brushed steel / шлифованная сталь

MC-J01A-25-01

25

chrom / chrome / хром

MC-J01A-25-06

25

stal szcztokowana / brushed steel / шлифованная сталь

stal / steel / сталь





Mocowanie J02  
Fixture J02  
Крепление J02

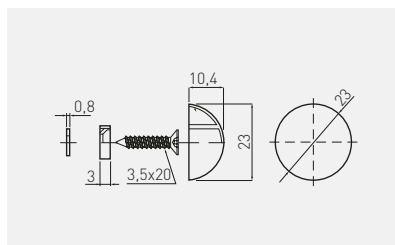

MC-J02A-25-01

23

chrom / chrome / хром

stal / steel / сталь



Mocowanie J04  
Fixture J04  
Крепление J04

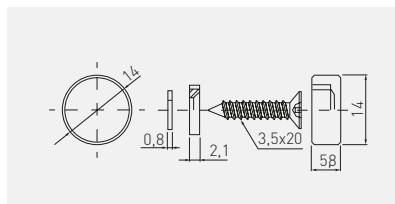

MC-J04A2-14-01

14

chrom / chrome / хром

MC-J04A2-14-06

14

stal szcztokowana / brushed steel / шлифованная сталь

MC-J04A2-18-01

18

chrom / chrome / хром

MC-J04A2-22-01

22

chrom / chrome / хром

MC-J04A2-22-06

22

stal szcztokowana / brushed steel / шлифованная сталь

ZnAl



Mocowanie J60  
Fixture J60  
Крепление J60

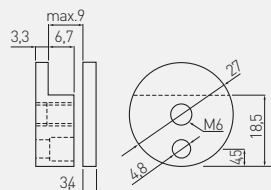

		
MC-J60A27-01	chrom / chrome / хром	ZnAl
MC-J60A27-06	stal szcztokowana / brushed steel / шлифованная сталь	



Mocowanie J62  
Fixture J62  
Крепление J62

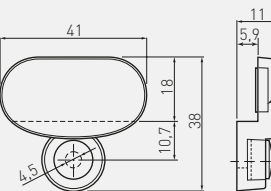

		
MC-J62-01	chrom / chrome / хром	ZnAl
MC-J62-06	stal szcztokowana / brushed steel / шлифованная сталь	



Mocowanie K90  
 Fixture K90  
 Крепление K90

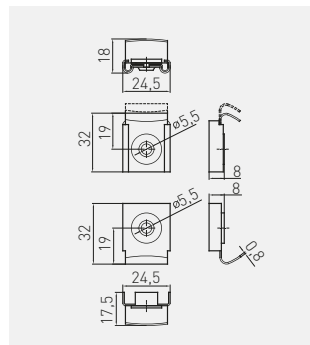

MC-K090-AR-01



chrom / chrome / хром



stal / steel / сталь



Mocowanie K91  
 Fixture K91  
 Крепление K91

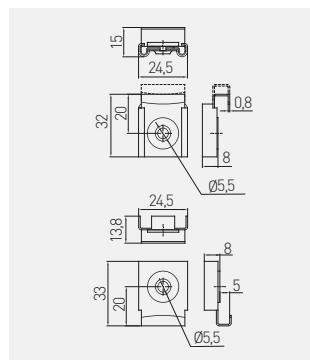

MC-K091-SQ-01



chrom / chrome / хром



stal / steel / сталь



Podpórka GL  
Shelf support GL  
Полкодержатель GL

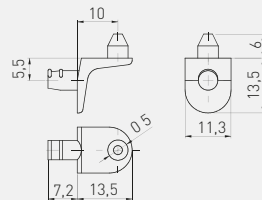

PP-GL-DR5-01



chrom / chrome / хром



ZnAl



Podpórka SAFETY  
Shelf support SAFETY  
Полкодержатель SAFETY

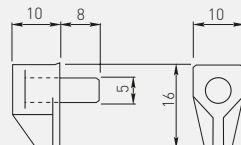

PP-SPL001-01

przeźroczysty  
transparent  
прозрачныйstal, tworzywo  
steel, plastic  
сталь, пластмасса

Podpórka MR-11  
Shelf support pin MR-11  
Полкодержатель MR-11

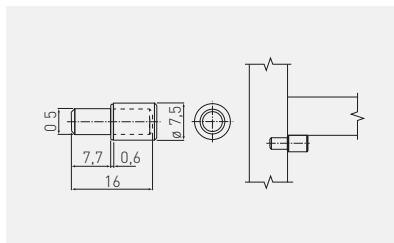

MR-ZSL011-01	z nakładką with plastic coating с накладкой	chrom / chrome / хром	stal / steel / сталь
MR-TDL011-01	bez nakładki without plastic coating без накладки		



Podpórka SMART  
Shelf support SMART  
Полкодержатель SMART

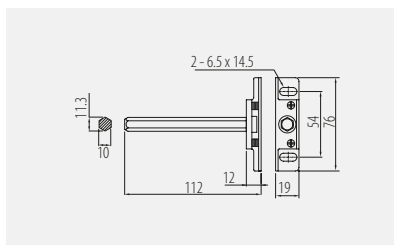

PP-SMART-000	srebrny / silver / серебристый	stal / steel / сталь



Podpórka CLEAR  
Shelf support CLEAR  
Полкодержатель CLEAR



	mm	mm	kg		
PP-NW09X90B	9	90	10	brąz brown коричневый	stal steel сталь
PP-NW10X100B	10	110	15		
PP-NW10X145B	10	145	15		
PP-NW12X120B	12	120	15		
PP-NW14X120B	14	120	25		
PP-NW14X140B	14	140	25		
PP-NW14X165B	14	165	25		

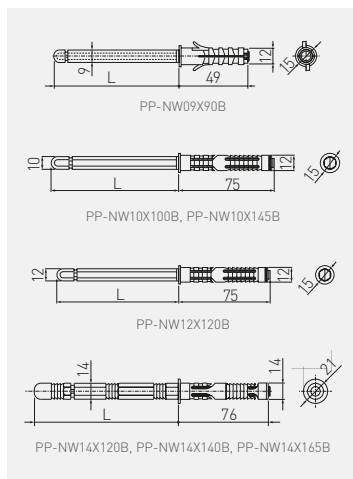

Podpórka LUK pod półkę  
Shelf support bracket LUK  
Полкодержатель LUK

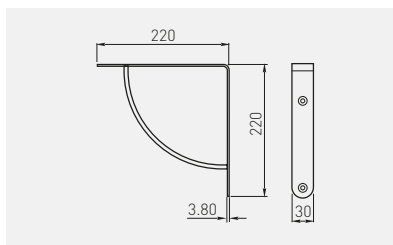

PP-LUK-00-01	30 / 2 szt. 30 / 2 pcs. 30 / 2 шт.	chrom / chrome / хром	stal steel сталь
PP-LUK-00-02		satyna / satin / сатин	
PP-LUK-00-05	aluminium / aluminium / алюминий		



Podpórka WB-24 pod półkę  
Shelf support bracket WB-24  
Полкодержатель WB-24

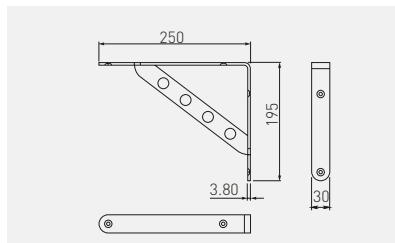





			
WB-073024-01	30 / 2 szt. 30 / 2 pcs.	chrom / chrome / хром	stal / steel / сталь
WB-073024-06	30 / 2 шт.	stal szorstkowana / brushed steel / шлифованная сталь	

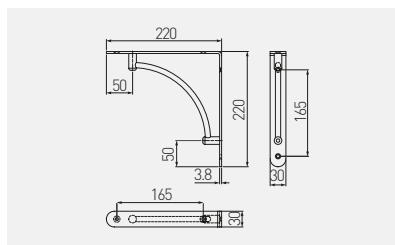

Podpórka WB-25 pod półkę  
Shelf support bracket WB-25  
Полкодержатель WB-25



			
WB-073025-01	30 / 2 szt. 30 / 2 pcs.	chrom / chrome / хром	stal / steel / сталь
WB-073025-06	30 / 2 шт.	stal szorstkowana / brushed steel / шлифованная сталь	



Podpórka WB-26 pod półkę  
Shelf support bracket WB-26  
Полкодержатель WB-26

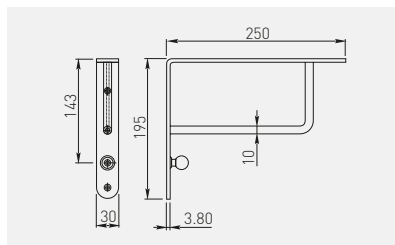

WB-073026-01		30 / 2 szt. 30 / 2 pcs.	chrom / chrome / хром	stal / steel / сталь
WB-073026-06		30 / 2 szt.	stal szczotkowana / brushed steel / шлифованная сталь	



Podpórka WS12  
Shelf support bracket WS12  
Полкодержатель WS12

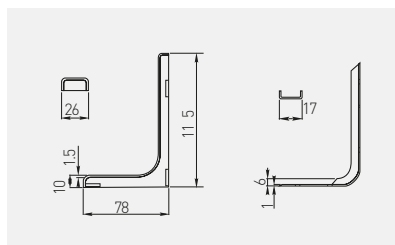

WB-WS-12-001	120	8 / 2 szt. 8 / 2 pcs. 8 / 2 шт.	chrom / chrome / хром	tworzywo plastic пластмасса	
WB-WS-12-010			biały / white / белый		
WB-WS-12-020			czarny / black / чёрный		
WB-WS-12-030			brąz / brown / коричневый		
WB-WS-12-031			ciemny brąz / dark brown / темно-коричневый		
WB-WS-12-032			jasny brąz / light brown / светло-коричневый		
WB-WS-12-033			kalwados / calvados / кальвадос		
WB-WS-12-060			szary / gray / серый		





## Podpórka WS18

### Shelf support bracket WS18

### Полкодержатель WS18

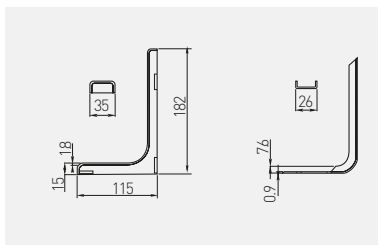

WB-WS-18-001	180	9,5 / 2 szt. 9,5 / 2 pcs. 9,5 / 2 шт.	chrom / chrome / хром	tworzywo plastic пластмасса
WB-WS-18-010	180		biały / white / белый	
WB-WS-18-020	180		czarny / black / чёрный	
WB-WS-18-030	180		brąz / brown / коричневый	
WB-WS-18-031	180		ciemny brąz / dark brown / темно-коричневый	
WB-WS-18-032	180		jasny brąz / light brown / светло-коричневый	
WB-WS-18-033	180		kalwados / calvados / кальвадос	
WB-WS-18-060	180		szary / gray / серый	



## Podpórka WS24

### Shelf support bracket WS24

### Полкодержатель WS24

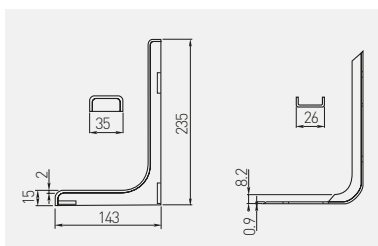

WB-WS-24-001	240	11 / 2 szt. 11 / 2 pcs. 11 / 2 шт.	chrom / chrome / хром	tworzywo plastic пластмасса
WB-WS-24-010	240		biały / white / белый	
WB-WS-24-020	240		czarny / black / чёрный	
WB-WS-24-030	240		brąz / brown / коричневый	
WB-WS-24-031	240		ciemny brąz / dark brown / темно-коричневый	
WB-WS-24-032	240		jasny brąz / light brown / светло-коричневый	
WB-WS-24-033	240		kalwados / calvados / кальвадос	
WB-WS-24-060	240		szary / gray / серый	



Kątownik FS01 szeroki  
Angle bracket FS01  
Широкий крепежный уголок FS01

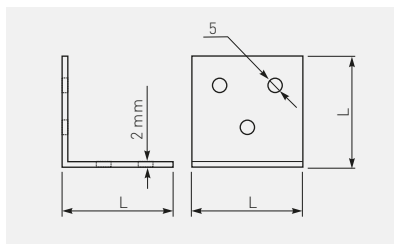

	 L mm		
KW-FS0125-01	25x25x24	chrom / chrome / хром	stal / steel / сталь
KW-FS0140-01	40x40x40		



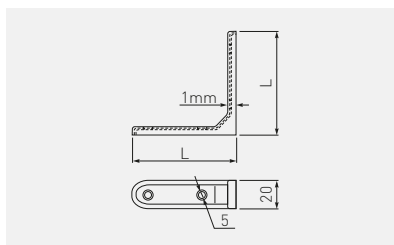

Kątownik FS03 wzmocniony  
Angle bracket FS03 reinforced  
Усиленный крепежный уголок FS03

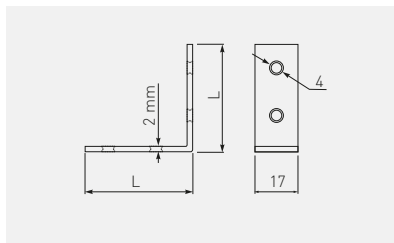

	 L mm		
KW-FS0335-01	35x35x20	chrom / chrome / хром	stal / steel / сталь
KW-FS0350-01	50x50x20		
KW-FS0375-01	75x75x20		

Кątownik FS04 standardowy  
 Angle bracket FS04 standard  
 Стандартный крепежный уголок FS04



	 L mm		
KW-FS0425-03	25x25x17	mosiądz / brass / латунь	stal / steel / сталь
KW-FS0430-03	30x30x17		
KW-FS0440-03	40x40x17		
KW-FS0450-03	50x50x17		
KW-FS0460-03	60x60x17		
KW-FS0475-03	75x75x17		

Кątownik FS06 narożnikowy  
 Corner bracket FS06  
 Угловой крепежный уголок FS06

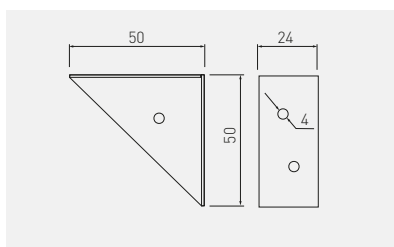

	 L mm		
KW-FS0650-01	50x50x24	chrom / chrome / хром	stal / steel / сталь

## Narożnik MONT pojedynczy Corner bracket MONT single Одинарный уголок MONT

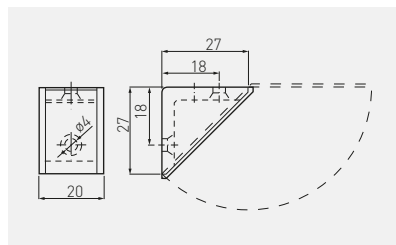

PP-PMONT0M-01	biały / white / белый	tworzywo plastic пластмасса
PP-PMONT0M-07	ciemny brąz / dark brown / темно-коричневый	
PP-PMONT0M-08	szary / gray / серый	
PP-PMONT0M-11	czarny / black / чёрный	
PP-PMONT0M-20	mahoń / mahogany / красное дерево	
PP-PMONT0M-22	kość stoniowa / ivory / слоновая кость	

## Narożnik MONT podwójny Corner bracket MONT double Двойной уголок MONT

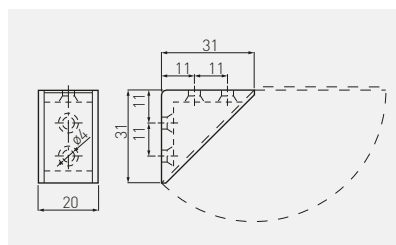

PP-PMONT0D-01	biały / white / белый	tworzywo plastic пластмасса
PP-PMONT0D-07	jasny brąz / light brown / светло-коричневый	
PP-PMONT0D-08	szary / gray / серый	
PP-PMONT0D-11	czarny / black / чёрный	
PP-PMONT0D-20	mahoń / mahogany / красное дерево	
PP-PMONT0D-22	kość stoniowa / ivory / слоновая кость	
PP-PMONT0D-01	olcha / alder / ольха	
PP-PMONT0D-50	beż / beige / бежевый	
PP-PMONT0D-724	wiśnia / cherry / вишня	
PP-PMONT0D-732	ciemny brąz / dark brown / темно-коричневый	

## Narożnik NARS pojedynczy Corner bracket NARS single Одинарный уголок NARS

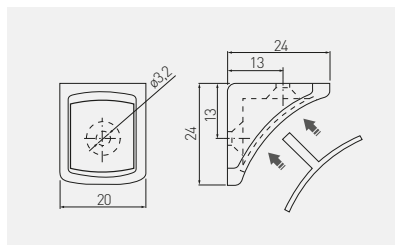

PM-NAR1003-512	kość stoniowa / ivory / слоновая кость	tworzywo plastic пластмасса
PM-NAR1003-645	szary / gray / серый	
PM-NAR1003-677	czarny / black / чёрный	
PM-NAR1003-680	biały / white / белый	
PM-NAR1003-695	srebrny / silver / серебристый	
PM-NAR1003-725	jasny brąz / light brown / светло-коричневый	
PM-NAR1003-728	beż / beige / бежевый	
PM-NAR1003-731	mahoń / mahogany / красное дерево	
PM-NAR1003-732	ciemny brąz / dark brown / темно-коричневый	
PM-NAR1003-770	grusza / pear / груша	
PM-NAR1003-771	olcha / alder / ольха	



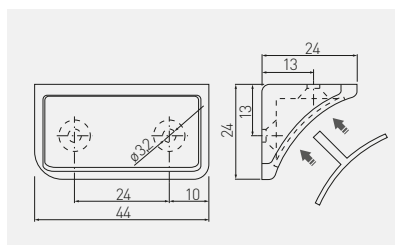

## Narożnik NARS podwójny Corner bracket NARS double Двойной уголок NARS

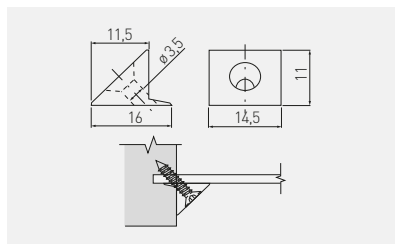

PM-NAR1004-512	kość stoniowa / ivory / слоновая кость	tworzywo plastic пластмасса
PM-NAR1004-645	szary / gray / серый	
PM-NAR1004-677	czarny / black / чёрный	
PM-NAR1004-680	biały / white / белый	
PM-NAR1004-695	aluminium / aluminium / алюминий	
PM-NAR1004-724	wiśnia / cherry / вишня	
PM-NAR1004-725	jasny brąz / light brown / светло-коричневый	
PM-NAR1004-728	beż / beige / бежевый	
PM-NAR1004-731	mahoń / mahogany / красное дерево	
PM-NAR1004-732	ciemny brąz / dark brown / темно-коричневый	
PM-NAR1004-770	grusza / pear / груша	
PM-NAR1004-771	olcha / alder / ольха	

Stabilizator ścianki tylnej  
Rear stabilizer  
Стабилизатор задней стенки



			
WZ-SCTYLPR-WK	Z wkrętem 3,5 x 20 With screw 3,5 x 20 С шурупом 3,5 x 20	biały white	tworzywo plastic
WZ-SCTYLPR-BWK	Bez wkręta Without screw Без шурупа	белый white	пластмасса plastic

Zawieszka niewidoczna FORCE  
Invisible kitchen hanger FORCE  
Скрытый навес FORCE

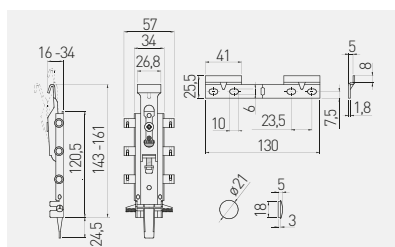

			
ZK-FORCE-KPL	100 / 2 szt. 100 / 2 pcs. 100 / 2 шт.	srebrny / silver / серебристый	ZnAl, stal / ZnAl, steel / ZnAl, сталь



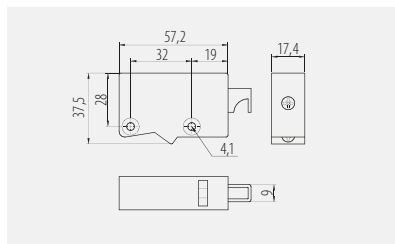

Zawieszka kuchenna R0 z regulacją  
Kitchen hanger R0 adjustable  
Навес кухонный R0 с регулировкой

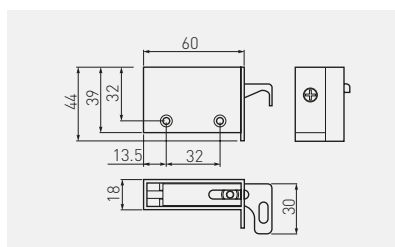

				
ZK-ZAW-R0-10		50 / 2 szt.	biały / white / белый	stal, tworzywo steel, plastic сталь, пластмасса
ZK-ZAW-R0-30		50 / 2 pcs.	brąz / brown / коричневый	
ZK-ZAW-R0-32		50 / 2 шт.	jasny brąz / light brown / светло-коричневый	

Zawieszka kuchenna R1  
Kitchen hanger R1  
Навес кухонный R1



				
ZK-R1-KPL-10		90 / 2 szt.	biały / white / белый	stal, tworzywo steel, plastic сталь, пластмасса
ZK-R1-KPL-30		90 / 2 pcs.	brąz / brown / коричневый	

## Zawieszka kuchenna STRONG

### Kitchen hanger STRONG

### Навес кухонный STRONG

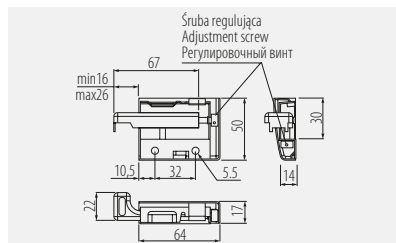

ZK-STRONG-L1	130 / 2 szt. 130 / 2 pcs.	lewa / left / левый	srebrny silver	stal, tworzywo steel, plastic
ZK-STRONG-P1	130 / 2 szt.	prawa / right / правый	srebrzysty серебристый	stal, plastmasa steel, plastic

## Zaślepka do zawieszki STRONG

### Hanger caps STRONG

### Заглушки для навесов STRONG

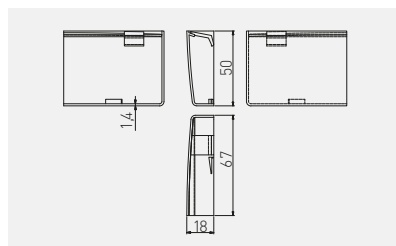





ZK-ZAS-L0-10	lewa / left / левая	biały / white / белый	tworzywo plastic пластмасса
ZK-ZAS-L0-15		beż / beige / бежевый	
ZK-ZAS-L0-31		ciemny brąz / dark brown / темно-коричневый	
ZK-ZAS-L0-32		jasny brąz / light brown / светло-коричневый	
ZK-ZAS-P0-10	prawa / right / правая	biały / white / белый	
ZK-ZAS-P0-15		beż / beige / бежевый	
ZK-ZAS-P0-31		ciemny brąz / dark brown / темно-коричневый	
ZK-ZAS-P0-32		jasny brąz / light brown / светло-коричневый	

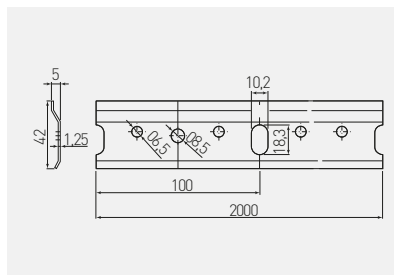

Listwa montażowa  
Mounting strip  
Монтажная планка







			
LO-M2M-00-125	2000	ocynk galvanized гальваника	stal steel сталь

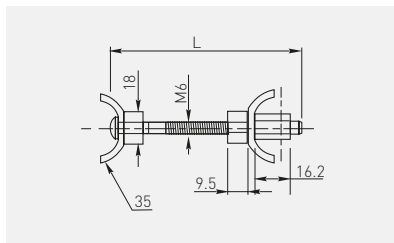







Złącze do blatów śrubowe  
Concealed worktop connector  
Стяжка для столешниц

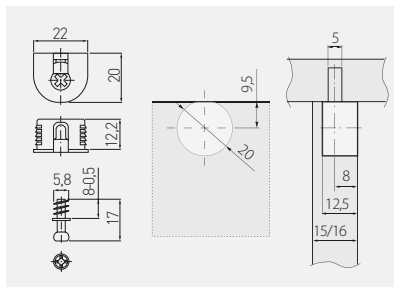

	 L mm		
EM-SBL060-01	60	chrom / chrome / хром	stal, tworzywo steel, plastic сталь, пластмасса
EM-SBL100-01	100		
EM-SBL150-01	150		

Złącze mimośrodowe  
Eccentric connecting fitting  
Эксцентрик



	 mm			
MM-FI20X6X7-PL10	20	trzpień 6x7mm dowel 6x7mm штифт 6x7mm	biały / white / белый	ZnAl, tworzywo ZnAl, plastic ZnAl, пластмасса
MM-FI20X6X7-PL20			czarny / black / чёрный	
MM-FI20X6X7-PL30			brąz / brown / коричневый	
MM-FI20X6X7-PL80			szary / gray / серый	
MM-FI20X6X7-ZN			srebrny / silver / серебристый	



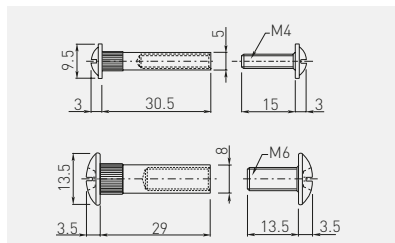

## Szybkozłącze Threaded sleeve, with internal thread Стяжки



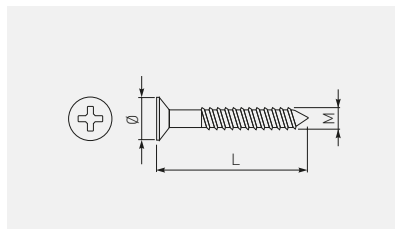



	 mm		
SZ-005-00-01	5	chrom / chrome / хром	stal / steel / сталь
SZ-008-00-01	8		

## Wkręty do drewna Screws for wood Мебельные метизы



	 mm		
WK-D0310-001	3 x 10	chrom chrome хром	stal steel сталь
WK-D0313-001	3 x 13		
WK-D0316-001	3 x 16		
WK-D0320-001*	3 x 20		
WK-D0325-001*	3 x 25		
WK-D0330-001*	3 x 30		
WK-D0416-001	4 x 16		
WK-D0420-001	4 x 20		
WK-D0425-001*	4 x 25		

	 mm		
WK-D0430-001	4 x 30	chrom chrome хром	stal steel сталь
WK-D0435-001	4 x 35		
WK-D0440-001*	4 x 40		
WK-D0460-001*	4 x 60		
WK-D3516-001	3,5 x 16		
WK-D3520-001*	3,5 x 20		
WK-D3525-001	3,5 x 25		
WK-D3530-001	3,5 x 30		

\*Produkt dostępny na indywidualne zamówienie / Available for special orders / Товар доступен под заказ

Konfirmat  
 Confirmat screw  
 Конфирмат

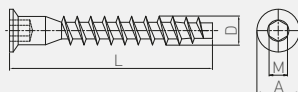

		L	D	A	M
WK-CF4450-01	6,4 x 50	50	6,4	9,5	4
WK-CF0750-01	7 x 50	50	7	10	4



WK-CF4450-01	chrom / chrome / хром	stal / steel / сталь
WK-CF0750-01		

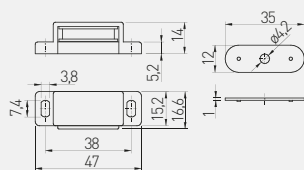

Magnes MENSA  
 Magnetic catch MENSA  
 Магнит MENSA

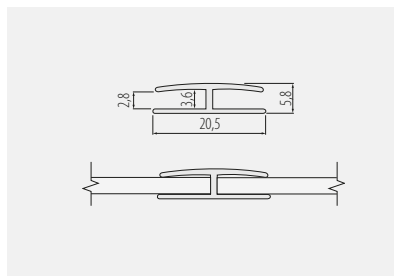

MG-MENSA-010	biały / white / белый	stal, tworzywo steel, plastic сталь, пластмасса
MG-MENSA-030	brąz / brown / коричневый	

Profil meblowy PFM - typ H  
 Furniture edge profile PFM - type H  
 Мебельный профиль PFM - тип H



	 mm		
PM-PFMH50-10	2000	biały / white / белый	tworzywo plastic пластмасса
PM-PFMH51-10	2000	ciemny brąz / dark brown / темно-коричневый	
PM-PFMH53-10	2000	jasny brąz / light brown / светло-коричневый	
PM-PFMH61-10	2000	ciemny mahoń / dark mahogany / темное красное дерево	
PM-PFMH64-10	2000	mahoń / mahogany / красное дерево	
PM-PFMH69-10	2000	beż / beige / бежевый	
PM-PFMH50-24	2400	biały / white / белый	
PM-PFMH50-25	2500	biały / white / белый	
PM-PFMH55-25	2500	czarny / black / чёрный	
PM-PFMH64-25	2500	mahoń / mahogany / красное дерево	

Listwa ozdobna płaska  
Flat decorative strip  
Плоская декоративная планка

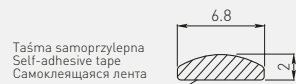

	 mm		
LO-00-00-001	2000	chrom / chrome / хром	tworzywo plastic пластмасса
LO-00-00-003	2000	mosiądz / brass / латунь	

Listwa ozdobna wypukła  
Convex decorative strip  
Выпуклая декоративная планка



	 mm		
LO-P0-00-010	2000	biały / white / белый	tworzywo plastic пластмасса
LO-P0-00-030	2000	brąz / brown / коричневый	

Profil do frontów PA-731  
Aluminium door profile PA-731  
Профиль PA-731 для фасадов

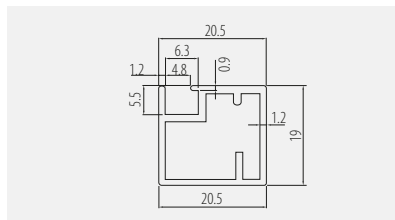

Łącznik do profili / Conector / Соединитель:



PA-LACZWASKI



PA-3731-35-50

aluminium / aluminium / алюминий

aluminium / aluminium / алюминий

Profil do frontów PA-730  
Aluminium door profile PA-730  
Профиль PA-730 для фасадов

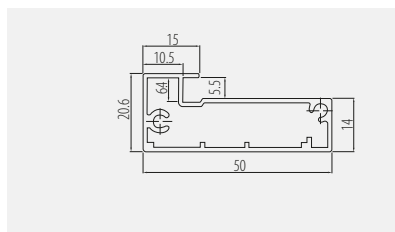

Łącznik do profili / Conector / Соединитель:



PA-LACZSZERO



PA-3730-35-50

aluminium / aluminium / алюминий

aluminium / aluminium / алюминий

Listwa boczna 28  
Worktop edging strip 28  
Торцевая планка 28

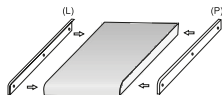

Do blatów o grubości 28 mm  
For worktops 28 mm thick  
Для столешниц толщиной 28 мм

		 L mm		
LMB-BOCZ28L-ALU	lewa / left / левая	600	aluminium aluminium алюминий	aluminium aluminium алюминий
LMB-BOCZ28P-ALU	prawa / right / правая			

Listwa boczna 38  
Worktop edging strip 38  
Торцевая планка 38

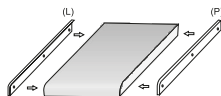

Do blatów o grubości 38 mm  
For worktops 38 mm thick  
Для столешниц толщиной 38 мм

		 L mm		
LMB-BOCZ38L-ALU	lewa / left / левая	600	aluminium aluminium алюминий	aluminium aluminium алюминий
LMB-BOCZ38P-ALU	prawa / right / правая			



Listwa SU boczna 28  
Worktop SU edging strip 28  
Торцевая планка SU 28

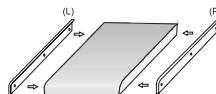

Do blatów o grubości 28 mm  
For worktops 28 mm thick  
Для столешниц толщиной 28 мм

				
LMB-SU-BOCZ28L-ALU	lewa / left / левая	600	aluminium aluminium алюминий	aluminium aluminium алюминий
LMB-SU-BOCZ28P-ALU	prawa / right / правая			

Listwa kątowna 28  
Worktop angle edging strip 28  
Угловая планка 28

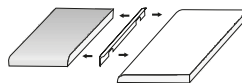



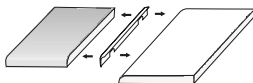

Do blatów o grubości 28 mm  
For worktops 28 mm thick  
Для столешниц толщиной 28 мм

			
LMB-KAT28-ALU	600	aluminium aluminium алюминий	aluminium aluminium алюминий

Listwa kąтова 38  
Worktop angle edging strip 38  
Угловая планка 38





Do blatów o grubości 38 mm  
For worktops 38 mm thick  
Для столешниц толщиной 38 мм

			
LMB-KAT38-ALU	600	aluminium aluminium алюминий	aluminium aluminium алюминий

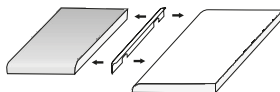
Listwa SU kąтова 28  
Worktop angle edging strip SU 38  
Торцевая планка SU 28



Do blatów o grubości 28 mm  
For worktops 28 mm thick  
Для столешниц толщиной 28 мм

			
LMB-SU-KAT28-ALU	600	aluminium aluminium алюминий	aluminium aluminium алюминий

Listwa szczelinowa 28  
Worktop joining strip 28  
Щелевая планка 28

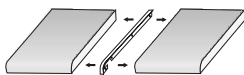



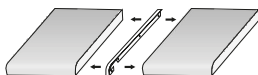

Do blatów o grubości 28 mm  
For worktops 28 mm thick  
Для столешниц толщиной 28 мм

			
LMB-SZCZ28-ALU	600	aluminium aluminium алюминий	aluminium aluminium алюминий

Listwa szczelinowa 38  
Worktop joining strip 38  
Щелевая планка 38



Do blatów o grubości 38 mm  
For worktops 38 mm thick  
Для столешниц толщиной 38 мм

			
LMB-SZCZ38-ALU	603	aluminium aluminium алюминий	aluminium aluminium алюминий

Listwa SU szczelinowa 28  
 Worktop joining strip SU 28  
 Щелевая планка SU 28

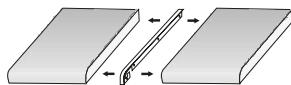

Do blatów o grubości 28 mm  
 For worktops 28mm thick  
 Для столешниц толщиной 28 мм



LMB-SU-SZCZ28-ALU	605	aluminium aluminium алюминий	aluminium aluminium алюминий
-------------------	-----	------------------------------------	------------------------------------



Drążek owalny  
 Oval wardrobe rail  
 Овальная труба для гардероба

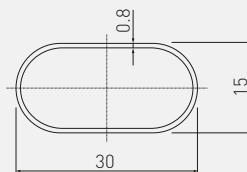

	 mm		
RR-CH-OW-000	3000	chrom / chrome / хром	stal / steel / сталь

Mocowanie RDR do drążka owalnego  
 RDR mounting bracket for oval wardrobe rail  
 Крепление RDR для овальной трубы

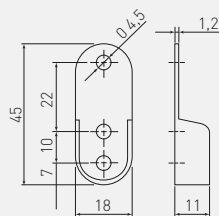

		
MR-RDRO-0000	chrom / chrome / хром	stal / steel / сталь

Uchwyt WP-28 do rury owalnej  
 WP-28 angle bracket for oval rail  
 Крепление дистанционное для овальной трубы

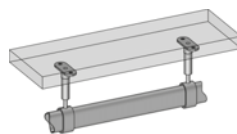
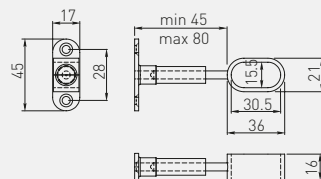

MR-WP-028-01





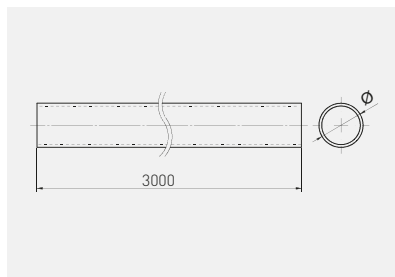

chrom / chrome / хром

ZnAl



Drążek okrągły  
Round wardrobe rail  
Мебельная штанга



		 mm	 mm	 mm		
RR-161030H01		16	1	3000	chrom chrome хром	stal steel сталь
RR-161230H01		16	1,2			
RR-250730H01		25	0,7			
RR-250830H01		25	0,8			
RR-250930H01		25	0,9			
RR-251030H01		25	1			
RR-401230H01		40	1,2			
RR-501030H01		50	1,2			
RR-501230H01		50	1,2			

Монтаж R-25 до дрэжка круглого  
R-25 mounting bracket for round rail  
Крепление R-25 для трубы

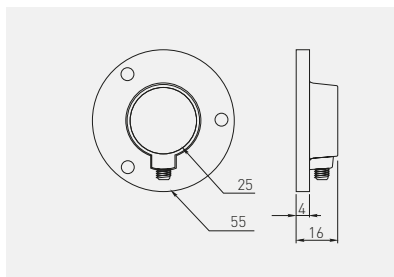

MR-RS025-001	25	chrom / chrome / хром	stal / steel / сталь
--------------	----	-----------------------	----------------------

Монтаж R-50 до дрэжка круглого  
R-50 mounting bracket for round rail  
Крепление R-50 для трубы

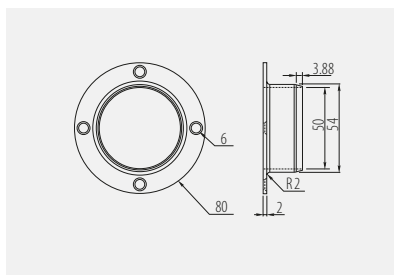

MR-R0050-001	50	chrom / chrome / хром	stal / steel / сталь
--------------	----	-----------------------	----------------------



Монowanie PZ-2 dolne do drążka okrągłego  
 PZ-2 bottom mounting bracket for round rail  
 Нижнее крепление PZ-2 для трубы

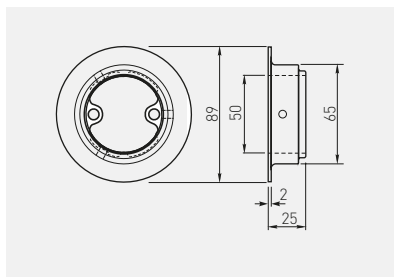

	 mm		
MR-WPZ002-01	50	chrom / chrome / хром	stal / steel / сталь

Pierścień mocujący PZ-3  
 Mounting ring PZ-3  
 Крепёжное кольцо PZ-3

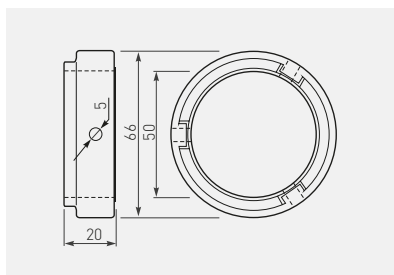

	 mm		
MR-WPZ003-01	50	chrom / chrome / хром	ZnAl

Uchwyt WP-10 dystansowy regulowany  
 WP-10 support bracket adjustable  
 Регулируемый кронштейн WP-10

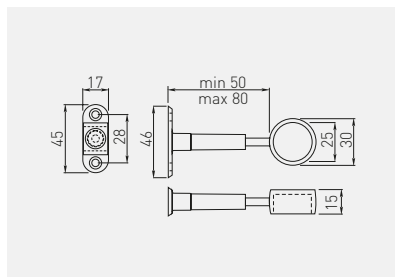

	 mm		
MR-WP-010-01	25	chrom / chrome / хром	ZnAl

Uchwyt WP-11 dystansowy regulowany z zaślepką  
 WP-11 support bracket adjustable with cover  
 Регулируемый кронштейн WP-11 с заглушкой

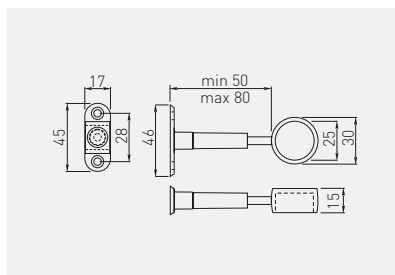

	 mm		
MR-WP-011-01	25	chrom / chrome / хром	ZnAl

Uchwyt THA-12 dystansowy przelotowy  
 THA-12 support bracket  
 Опорный кронштейн THA-12 сквозной

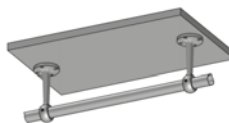
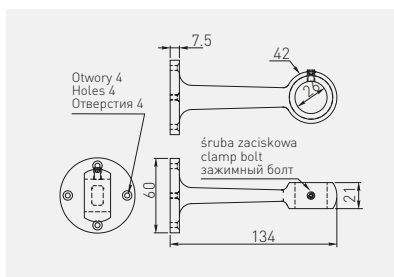

MR-THA12-001	25	chrom / chrome / хром	ZnAl
--------------	----	-----------------------	------

Uchwyt THB-12 dystansowy  
 THB-12 support bracket  
 Опорный кронштейн THB-12

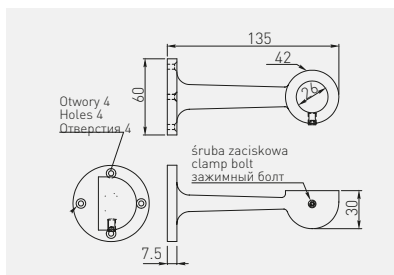

MR-THB12-001	25	chrom / chrome / хром	ZnAl
--------------	----	-----------------------	------

Łącznik WP-13  
 WP-13 connector  
 Соединитель WP-13

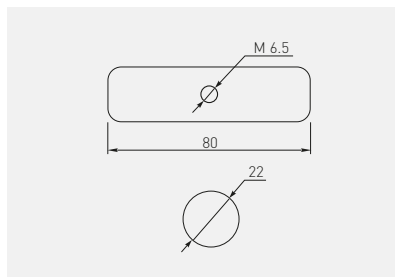

		
MR-WP013-001	осынок / galvanized / гальваника	ZnAl

Złącze TH-5 dwuramiennie  
 TH-5 connector  
 Муфта TH-5 двухраструбная

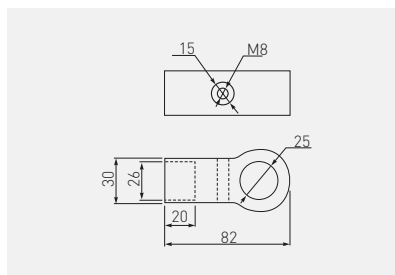

			
MR-TH005-001	25 mm	chrom / chrome / хром	ZnAl

Złącze TH-16 dwuramiennie  
 TH-16 connector  
 Муфта двухраструбная TH-16

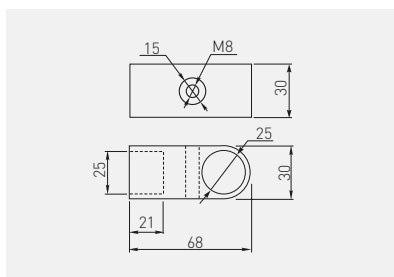

MR-TH016-001	25	chrom / chrome / хром	ZnAl
--------------	----	-----------------------	------

Złącze TH-4 dwuramiennie typ T  
 TH-4 connector type T  
 Муфта TH-4 двухраструбная тип T

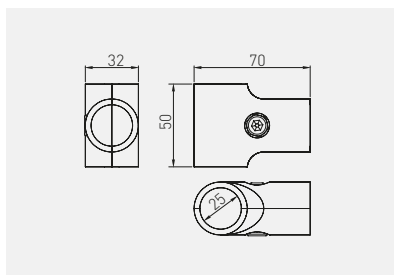

MR-TH004-001	25	chrom / chrome / хром	ZnAl
--------------	----	-----------------------	------

Zestaw złączy TH-18 typ L  
 TH-18 connector type L  
 Набор муфт TH-18 тип L

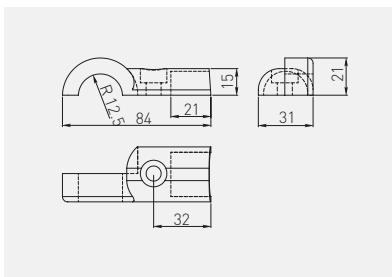

Możliwość uzyskania różnych pozożeń połączenia  
 The possibility of obtaining various positions of connection  
 Возможность получения разных положений соединения

MR-TH018-KPL	prawy / lewy right / left правый / левый	25	chrom / chrome / хром	ZnAl

Zestaw złączy T-18 typ T  
 T-18 connectors set type T  
 Набор муфт TH-18 тип T

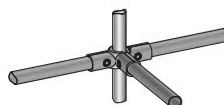
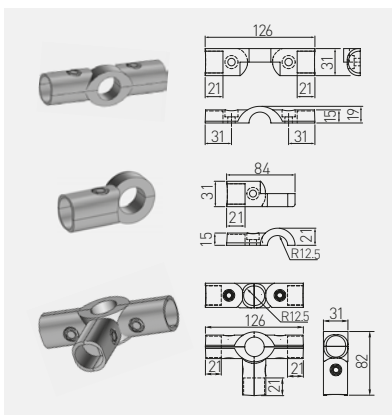

MR-T1824-KPL	25	chrom / chrome / хром	ZnAl

Zestaw złączy TH-24  
TH-24 connectors set  
Набор муфт TH-24

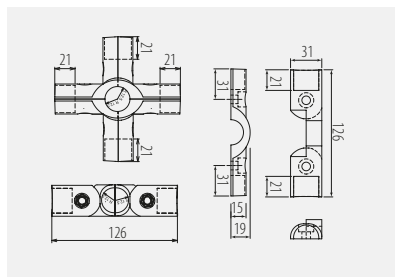

MR-TH024-KPL	25	chrom / chrome / хром	ZnAl
--------------	----	-----------------------	------

Złącze TH-11 zawiasowe  
TH-11 hinge connector  
Муфта шарнирная TH-11

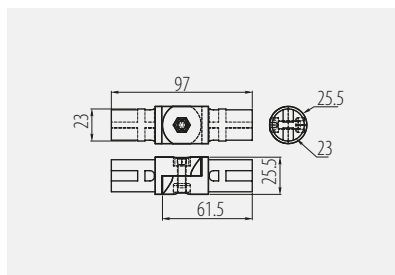

Możliwość dostosowania kąta złączy do założonego położenia (do 180°)  
The possibility of adjustment of angle connector arms to the desired position (up to 180°)  
Возможность регулировки угла стыковки соединителей к заданному положению (180°)



MR-TH011-001	chrom / chrome / хром	ZnAl
--------------	-----------------------	------

Złącze TH-9  
TH-9 connector  
Муфта TH-9

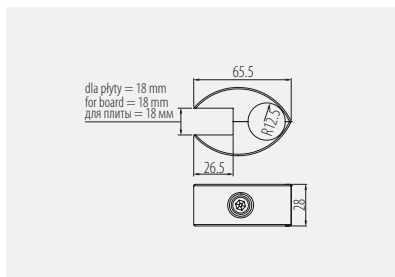

MR-TH009-001

chrom / chrome / хром

ZnAl



Zalecana grubość szkła z użyciem wkładek: od 4 do 8 mm  
Recommended glass thickness with inserts: from 4 to 8 mm  
Рекомендуемая толщина стекла с использованием вкладышей: от 4 до 8 мм

Złącze TH-10 dwustronne  
TH-10 connector  
Муфта TH-10 двухсторонняя

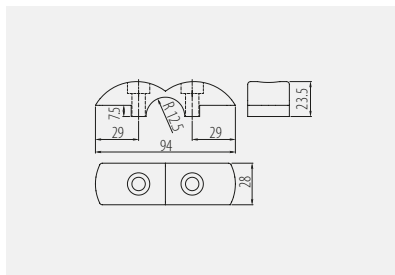

MR-TH010-001

chrom / chrome / хром

ZnAl



Zalecana grubość szkła z użyciem wkładek: od 4 do 8 mm  
Recommended glass thickness with inserts: from 4 to 8 mm  
Рекомендуемая толщина стекла с использованием вкладышей: от 4 до 8 мм



Zestaw złączy TH-35  
TH-35 set of connectors  
Набор муфт TH-35

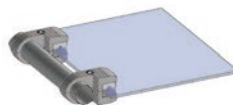
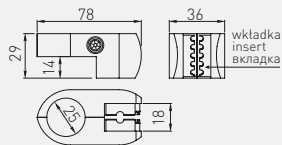

MR-TH035-KPL	25	chrom / chrome / хром	ZnAl



Zalecana grubość szkła z użyciem wkładek: od 4 do 8 mm  
Recommended glass thickness with inserts: from 4 to 8 mm  
Рекомендуемая толщина стекла с использованием вкладышей: от 4 до 8 мм

Złącze WP-14 dwustronne  
WP-14 connector  
Муфта WP-14 двухсторонняя

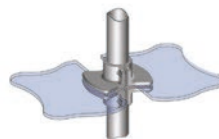
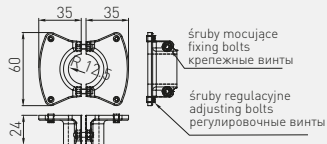

MR-WP-14-KPL	25	chrom / chrome / хром	ZnAl



Złącze WP-15  
WP-15 connector  
Муфта WP-15

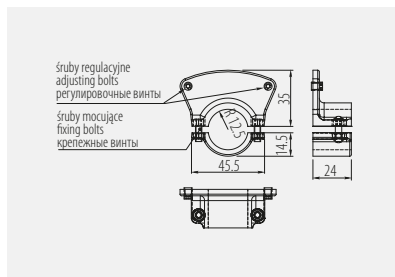

	 mm		
MR-WP-15-KPL	25	chrom / chrome / хром	ZnAl

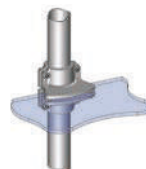

Złącze TH-1 równoległe  
TH-1 connector parallel  
Муфта TH-1 равнопроходная

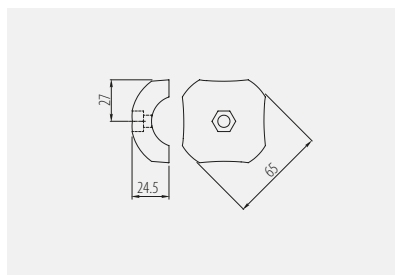

		
MR-TH001-01	chrom / chrome / хром	ZnAl

Złącze TH-2 potrójne  
TH-2 connector three-way  
Муфта TH-2 тройная

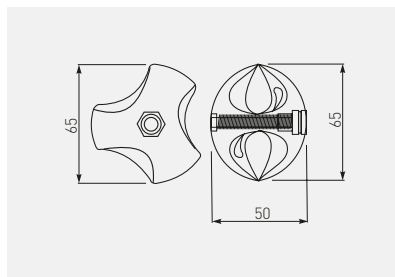

			
MR-TH002-L01	lewy / left / левый	chrom / chrome / хром	ZnAl
MR-TH002-P01	prawy / right / правый		

Złącze TH-18 podwójne  
TH-18 double connector  
Муфта TH-18 двойная

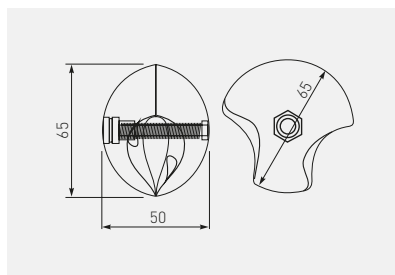

			
MR-TH018-L01	lewy / left / левый	chrom / chrome / хром	ZnAl
MR-TH018-P01	prawy / right / правый		

Zaślepka okrągła  
Round end cap  
Круглая заглушка

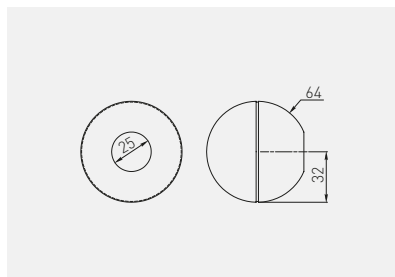

	 mm		
MR-THQZ1-001	25	chrom / chrome / хром	ZnAl

Zaślepka TH-19  
TH-19 end cap  
Заглушка TH-19

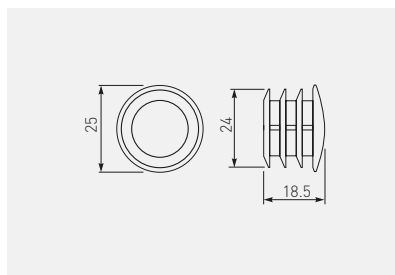

	 mm		
MR-TH019-001	25	chrom / chrome / хром	ZnAl

Stopka plastikowa zewnętrzna  
Plastic end cap  
Внешняя ножка, пластмассовая

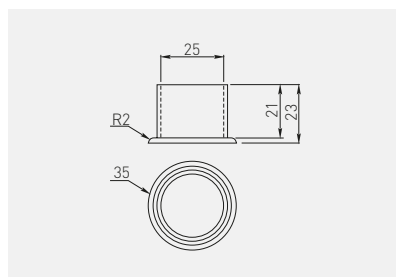

MR-TH019-003	25	czarny / black / чёрный	tworzywo / plastic / пластмасса
--------------	----	-------------------------	---------------------------------

Uchwyt THA-48 z przyssawką  
THA-48 handle with suction cup  
Крепление THA-48 с присоской

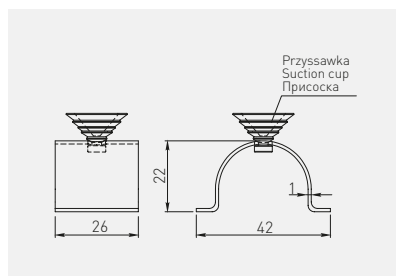

MR-TH048-001	25	chrom / chrome / хром	stal, tworzywo / steel, plastic / сталь, пластмасса
--------------	----	-----------------------	---

Монтование PZ-6 гóрне розпорове  
 PZ-6 expandable end support bracket  
 Верхнее крепление PZ-6

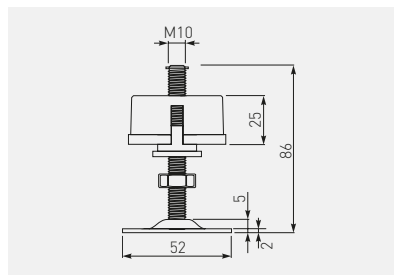

MR-WPZ006-01	50	chrom / chrome / хром	stal, tworzywo / steel, plastic / сталь, пластмасса
--------------	----	-----------------------	---



Uchwyt do relingu prosty  
 Rail support  
 Ручка для рейлинга прямая

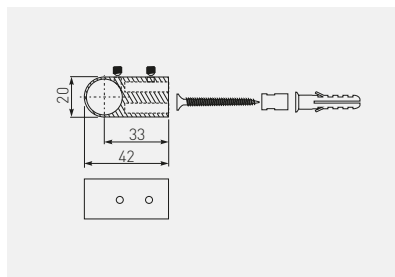

MR-WP2802-01	16	chrom / chrome / хром	ZnAl
--------------	----	-----------------------	------

Zaślepka do relingu prosta  
 End cap  
 Заглушка для рейлинга прямая

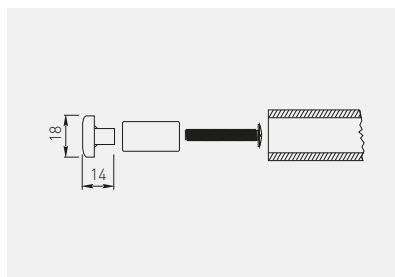

MR-WP2815-01	16	chrom / chrome / хром	ZnAl
--------------	----	-----------------------	------

Uchwyt do relingu  
Rail support  
Ручка для рейлинга

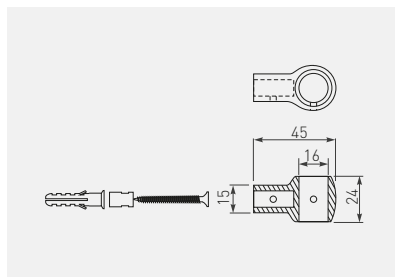

MR-WP2804-01	16	chrom / chrome / хром	ZnAl
--------------	----	-----------------------	------

Zaślepka do relingu  
End cap  
Заглушка для рейлинга

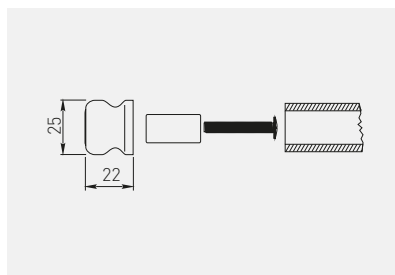

MR-WP2806-01	16	chrom / chrome / хром	ZnAl, tworzywo / ZnAl, plastic / ZnAl, пластмасса
--------------	----	-----------------------	---



Łącznik do relingu  
 Rail connector  
 Соединитель для рейлинга

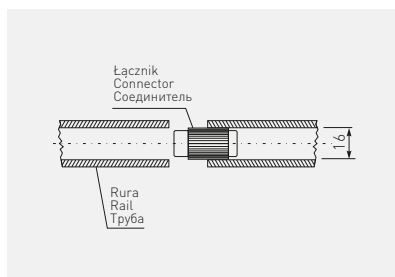

	 mm		
MR-WP2807-20	16	czarny / black / чёрный	tworzywo / plastic / пластмасса

Zaślepka do relingu z gwintem  
 End cap with thread for rails  
 Заглушка для рейлинга с резьбой

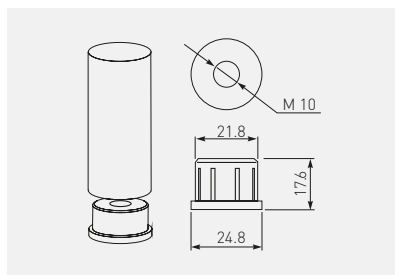

		
MR-WPZ023-01	chrom / chrome / хром	ZnAl

Haczyki do relingu PS1  
 Hooks for rails PS1  
 Крючки для рейлинга PS1

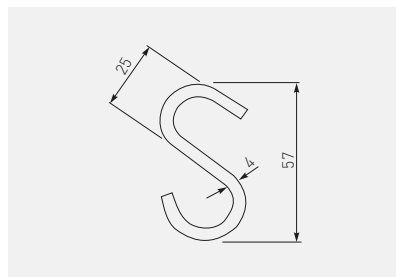

	 mm		
MR-WPS01-001	16	chrom / chrome / хром	stal / steel / сталь



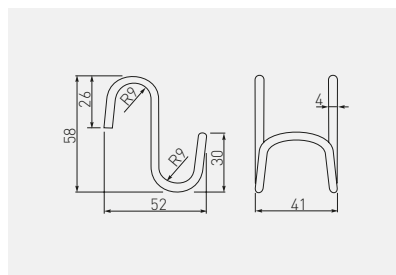

Haczyki do relingu PS3  
 Hooks for rails PS3  
 Крючки для рейлинга PS3

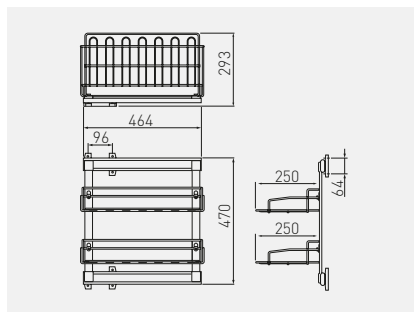

	 mm		
MR-WPS03-001	16	chrom / chrome / хром	stal / steel / сталь

Kosz dwupoziomowy na obuwie  
Two tier pull out shoes rack  
Двухуровневая корзина для обуви



				
PP-20BUW0-05	lewy / prawy left / right левый / правый	niepełny partial неполное	chrom, aluminium, czarny chrome, aluminium, black хром, алюминий, чёрный	stal, aluminium, tworzywo steel, aluminium, plastic сталь, алюминий, пластмасса

Szuflada na obuwie 600  
Pull out shoes rack 600  
Полка для обуви 600

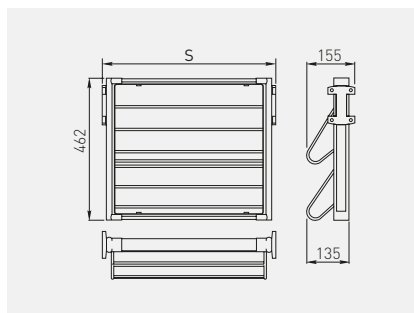

		<b>S</b> min/max			
PP-0BUW60-05	niepełny partial неполное	560 – 581	chrom chrome хром	chrom, aluminium, czarny chrome, aluminium, black хром, алюминий, чёрный	stal, aluminium, tworzywo steel, aluminium, plastic сталь, алюминий, пластмасса
PP-0BUW60-PW	pełny full полное	564 – 585			

Szuflada na obuwie 900  
Pull out shoes rack 900  
Полка для обуви 900

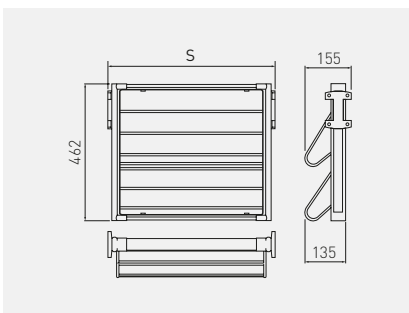

		<b>S</b> min/max			
PP-0BUW90-05	nierpety partial неполное	860-881	chrom chrome хром	chrom, aluminium, czarny chrome, aluminium, black хром, алюминий, чёрный	stal, aluminium, tworzywo steel, aluminium, plastic сталь, алюминий, пластмасса
PP-0BUW90-PW	rpety full полное	864-885			

Kosz dwupoziomowy  
Two tier wardrobe basket  
Двухуровневая корзина

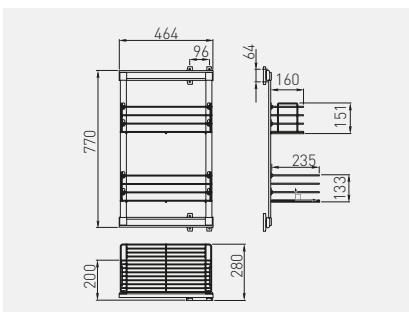

WW-2KOSZ0-05	lewy / prawy left / right левый / правый	nierpety partial неполное	chrom, aluminium, czarny chrome, aluminium, black хром, алюминий, чёрный	stal, aluminium, tworzywo steel, aluminium, plastic сталь, алюминий, пластмасса

Kosz do szaf 600  
 Wardrobe basket 600  
 Корзина для шкафа 600

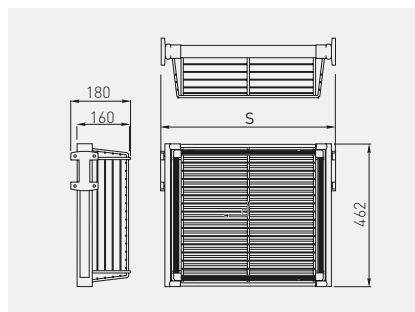

		 S min/max			
WW-KOSZ60-01	niepełny partial неполное	560-581	chrom chrome хром	chrom, aluminium, czarny chrome, aluminium, black хром, алюминий, чёрный	stal, aluminium, tworzywo steel, aluminium, plastic сталь, алюминий, пластмасса
WW-KOSZ60-PW	pełny full полное	564-585			



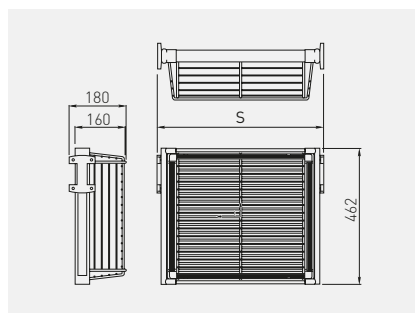





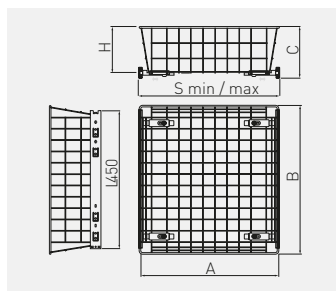



Kosz do szaf 900  
 Wardrobe basket 900  
 Корзина для шкафа 900



		 S min/max			
WW-KOSZ90-01	niepełny partial неполное	860-881	chrom chrome хром	chrom, aluminium, czarny chrome, aluminium, black хром, алюминий, чёрный	stal, aluminium, tworzywo steel, aluminium, plastic сталь, алюминий, пластмасса
WW-KOSZ90-PW	pełny full полное	864-885			







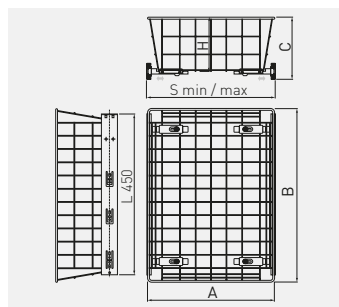

Kosz na prowadnicy kulkowej H35  
 Wardrobe basket on a H35 ball bearing slide  
 Корзина на шариковых направляющих H35



		 mm	 mm	 mm	 mm	 mm	 S min/max						
KO-SRH35100-30-10		300	100	255	485	68	260-285						
KO-SRH35100-40-10		400	100	355	485	68	360-385						
KO-SRH35100-50-10		500	100	455	485	68	460-485						
KO-SRH35100-60-10		600	100	555	485	68	560-585						
KO-SRH35150-30-10		300	150	255	485	118	260-285						
KO-SRH35150-40-10		400	150	355	485	118	360-385						
KO-SRH35150-50-10		500	150	455	485	118	460-485						
KO-SRH35150-60-10		600	150	555	485	118	560-585						
KO-SRH35200-30-10		300	200	255	485	168	260-285						
KO-SRH35200-40-10		400	200	355	485	168	360-385						
KO-SRH35200-50-10		500	200	455	485	168	460-485						
KO-SRH35200-60-10		600	200	555	485	168	560-585						
KO-SRH35100-30-OC		300	100	255	485	68	260-285				ocynk galvanized гальваника	biały white белый	stal steel сталь
KO-SRH35100-40-OC		400	100	355	485	68	360-385						
KO-SRH35100-50-OC		500	100	455	485	68	460-485						
KO-SRH35100-60-OC		600	100	555	485	68	560-585						
KO-SRH35150-30-OC		300	150	255	485	118	260-285						
KO-SRH35150-40-OC		400	150	355	485	118	360-385						
KO-SRH35150-50-OC		500	150	455	485	118	460-485						
KO-SRH35150-60-OC		600	150	555	485	118	560-585						
KO-SRH35200-30-OC		300	200	255	485	168	260-285						
KO-SRH35200-40-OC		400	200	355	485	168	360-385						
KO-SRH35200-50-OC		500	200	455	485	168	460-485						
KO-SRH35200-60-OC		600	200	555	485	168	560-585						
KO-SRH35100-30-OC		300	100	255	485	68	260-285	srebrny silver серебристый					
KO-SRH35100-40-OC		400	100	355	485	68	360-385						
KO-SRH35100-50-OC		500	100	455	485	68	460-485						
KO-SRH35100-60-OC		600	100	555	485	68	560-585						
KO-SRH35150-30-OC		300	150	255	485	118	260-285						
KO-SRH35150-40-OC		400	150	355	485	118	360-385						
KO-SRH35150-50-OC		500	150	455	485	118	460-485						
KO-SRH35150-60-OC		600	150	555	485	118	560-585						
KO-SRH35200-30-OC		300	200	255	485	168	260-285						
KO-SRH35200-40-OC		400	200	355	485	168	360-385						
KO-SRH35200-50-OC		500	200	455	485	168	460-485						
KO-SRH35200-60-OC		600	200	555	485	168	560-585						

Kosz na prowadnicy kulkowej H45 ze spawalniczem  
 Wardrobe basket on a H45 adjustable ball bearing slide  
 Корзина на шариковых направляющих H45



		 H mm	 A mm	 B mm	 C mm	 S min/max			
KO-SRH4550-30-10	300	50	255	485	73	260-285			
KO-SRH4550-40-10	400	50	355	485	73	360-385			
KO-SRH4550-50-10	500	50	455	485	73	460-485			
KO-SRH4550-60-10	600	50	555	485	73	560-585			
KO-SRH45100-30-10	300	100	255	485	123	260-285			
KO-SRH45100-40-10	400	100	355	485	123	360-385			
KO-SRH45100-50-10	500	100	455	485	123	460-485			
KO-SRH45100-60-10	600	100	555	485	123	560-585			
KO-SRH45150-30-10	300	150	255	485	173	260-285			
KO-SRH45150-40-10	400	150	355	485	173	360-385			
KO-SRH45150-50-10	500	150	455	485	173	460-485			
KO-SRH45150-60-10	600	150	555	485	173	560-585			
KO-SRH45200-30-10	300	200	255	485	223	260-285			
KO-SRH45200-40-10	400	200	355	485	223	360-385			
KO-SRH45200-50-10	500	200	455	485	223	460-485			
KO-SRH45200-60-10	600	200	555	485	223	560-585			
KO-SRH4550-30-0C	300	50	255	485	73	260-285			
KO-SRH4550-40-0C	400	50	355	485	73	360-385			
KO-SRH4550-50-0C	500	50	455	485	73	460-485			
KO-SRH4550-60-0C	600	50	555	485	73	560-585			
KO-SRH45100-30-0C	300	100	255	485	123	260-285			
KO-SRH45100-40-0C	400	100	355	485	123	360-385			
KO-SRH45100-50-0C	500	100	455	485	123	460-485			
KO-SRH45100-60-0C	600	100	555	485	123	560-585			
KO-SRH45150-30-0C	300	150	255	485	173	260-285			
KO-SRH45150-40-0C	400	150	355	485	173	360-385			
KO-SRH45150-50-0C	500	150	455	485	173	460-485			
KO-SRH45150-60-0C	600	150	555	485	173	560-585			
KO-SRH45200-30-0C	300	200	255	485	223	260-285			
KO-SRH45200-40-0C	400	200	355	485	223	360-385			
KO-SRH45200-50-0C	500	200	455	485	223	460-485			
KO-SRH45200-60-0C	600	200	555	485	223	560-585			

biały  
white  
белый









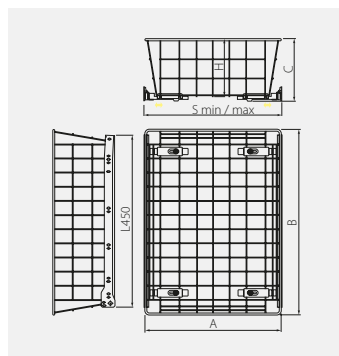

osynk  
galvanized  
гальваника

stal  
steel  
сталь

srebrny  
silver  
серебристый

Kosz na prowadnicy rolkowej L = 450  
 Wardrobe basket on a L=450 slide  
 Корзина на роликовых направляющих L450



		 mm	 mm	 mm	 mm	 mm	 mm			
		mm	mm	A mm	B mm	C mm	S min/max			
KO-SRPR100-30-10		300	100	255	485	123	260-285			
KO-SRPR100-40-10		400	100	355	485	123	360-385			
KO-SRPR100-50-10		500	100	455	485	123	460-485			
KO-SRPR100-60-10		600	100	555	485	123	560-585			
KO-SRPR150-30-10		300	150	255	485	173	260-285			
KO-SRPR150-40-10		400	150	355	485	173	360-385			
KO-SRPR150-50-10		500	150	455	485	173	460-485			
KO-SRPR150-60-10		600	150	555	485	173	560-585			
KO-SRPR200-30-10		300	200	255	485	223	260-285			
KO-SRPR200-40-10		400	200	355	485	223	360-385			
KO-SRPR200-50-10		500	200	455	485	223	460-485			
KO-SRPR200-60-10		600	200	555	485	223	560-585			
KO-SRPR150-30-OC		300	150	255	485	123	260-285			
KO-SRPR100-40-OC		400	100	355	485	123	360-385			
KO-SRPR100-30-OC		300	100	455	485	123	460-485			
KO-SRPR100-50-OC		500	100	555	485	123	560-585			
KO-SRPR100-60-OC		600	100	255	485	173	260-285			
KO-SRPR150-40-OC		400	150	355	485	173	360-385			
KO-SRPR150-50-OC		500	150	455	485	173	460-485			
KO-SRPR150-60-OC		600	150	555	485	173	560-585			
KO-SRPR200-30-OC		300	200	255	485	223	260-285			
KO-SRPR200-40-OC		400	200	355	485	223	360-385			
KO-SRPR200-50-OC		500	200	455	485	223	460-485			
KO-SRPR200-60-OC		600	200	555	485	223	560-585			

osynk  
galvanized  
гальваника

biały  
white  
белый





stal  
tworzywo  
steel  
plastic  
сталь  
пластмасса

srebrny  
silver  
серебристый

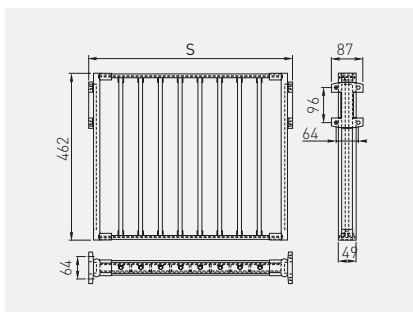





Wieszak na spodnie 600  
 Wardrobe trouser rack 600  
 Вешалка для брюк 600

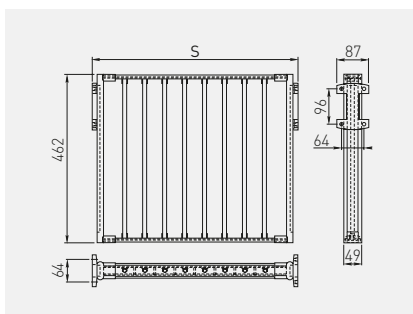

			S min/max		
WW-WSP060-05	niepełny partial неполное		560-581	chrom, aluminium, czarny chrome, aluminium, black хром, алюминий, чёрный	stal, aluminium, tworzywo steel, aluminium, plastic сталь, алюминий, пластмасса
WW-WSP060-PW	pełny full полное		564-585		





Wieszak na spodnie 900  
 Wardrobe trouser rack 900  
 Вешалка для брюк 900

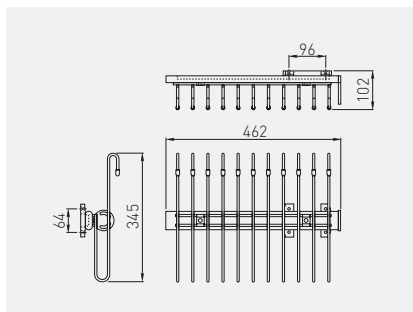

			S min/max		
WW-WSP090-05	niepełny partial неполное		860-881	chrom, aluminium, czarny chrome, aluminium, black хром, алюминий, чёрный	stal, aluminium, tworzywo steel, aluminium, plastic сталь, алюминий, пластмасса
WW-WSP090-PW	pełny full полное		864-885		



Wieszak na spodnie podwieszany  
 Wardrobe pull-out trouser rack  
 Вешалка для брюк 600 подвесная



			
WW-WSP000-01	niepetyny partial неполное	chrom, aluminium, czarny chrome, aluminium, black хром, алюминий, чёрный	stal, aluminium, tworzywo steel, aluminium, plastic сталь, алюминий, пластмасса

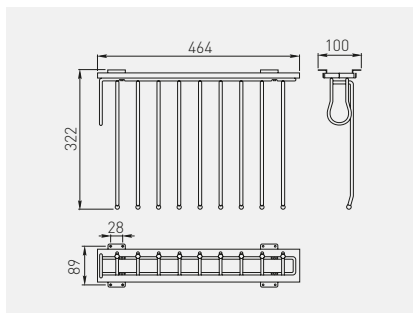



Wieszak WS na spodnie  
 Trouser rack WS  
 Вешалка WS для брюк

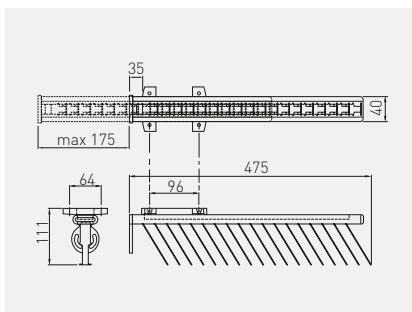

				
WW-WSP000-01	prawy right правый	niecetyny partial неполное	chrom, aluminium, czarny chrome, aluminium, black хром, алюминий, чёрный	stal, aluminium, tworzywo steel, aluminium, plastic сталь, алюминий, пластмасса
WW-WSL000-01	lewy left левый			

Wieszak KRA na krawaty  
 Tie hanger KRA  
 Подвеска для галстуков KRA



				
WW-KRAW00-20	lewy / prawy left / right левый / правый	niepełny partial неполное	chrom, aluminium, czarny chrome, aluminium, black хром, алюминий, чёрный	stal, aluminium, tworzywo steel, aluminium, plastic сталь, алюминий, пластмасса

Wieszak KJ na krawaty  
 Tie hanger KJ  
 Подвеска для галстуков KJ

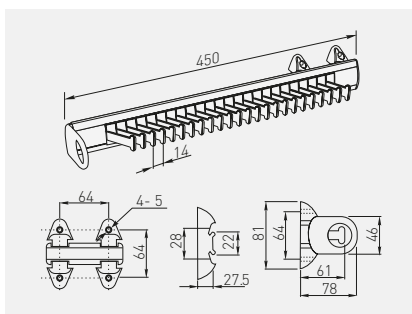

				
WW-KJ0101-01	lewy / prawy left / right левый / правый	niepełny partial неполное	aluminium, czarny aluminium, black алюминий, чёрный	stal, aluminium, tworzywo steel, aluminium, plastic сталь, алюминий, пластмасса



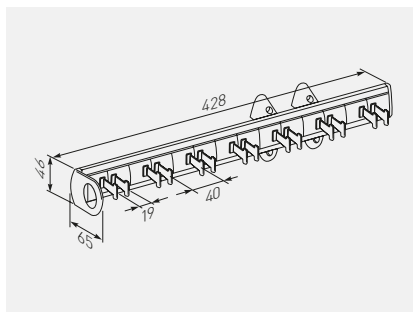

Wieszak KJ na paski  
Belt rack KJ  
Вешалка KJ для ремней

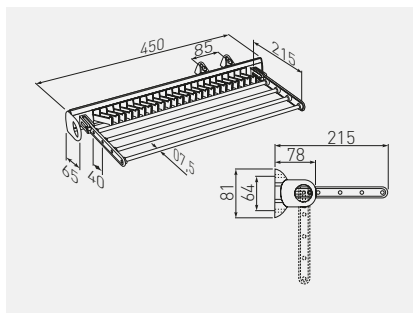

				
WW-KJ0201-01	lewy / prawy left / right левый / правый	niepełny partial неполное	aluminium, czarny aluminium, black алюминий, чёрный	stal, aluminium, tworzywo steel, aluminium, plastic сталь, алюминий, пластмасса





Wieszak J03 na krawaty i spodnie  
Trouser and tie hanger J03  
Вешалка J03 для брюк и галстуков

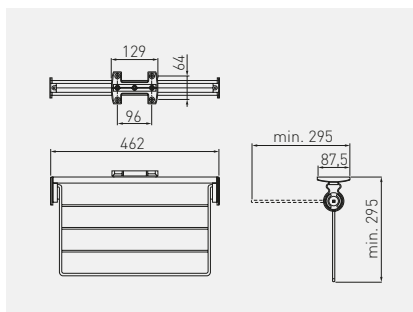

				
WW-K0AJ03-01	lewy / prawy left / right левый / правый	niepełny partial неполное	chrom, aluminium, czarny chrome + aluminium, black хром, алюминий, чёрный	stal, aluminium, tworzywo steel, aluminium, plastic сталь, алюминий, пластмасса

Wieszak na spodnie składany  
 Foldable trouser rack  
 Вешалка для брюк, складная



				
WW-SPODN0-05	lewy / prawy left / right левый / правый	niepełny partial неполное	chrom, aluminium, czarny chrome, aluminium, black хром, алюминий, чёрный	stal, aluminium, tworzywo steel, aluminium, plastic сталь, алюминий, пластмасса

Wieszak J03 na spodnie  
 Trouser rack J03  
 Вешалка J03 для брюк

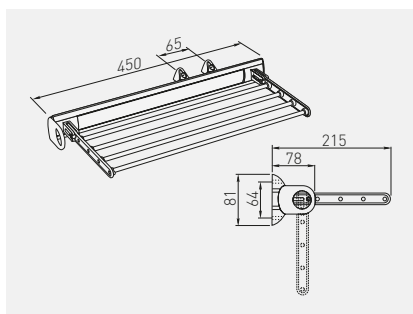

				
WW-K00J03-01	lewy / prawy left / right левый / правый	niepełny partial неполное	aluminium, czarny aluminium, black алюминий, чёрный	aluminium, tworzywo aluminium, plastic алюминий, пластмасса



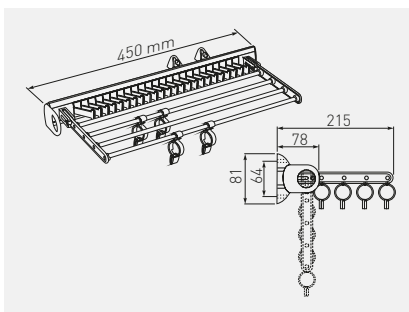

Wieszak J04 na krawaty i spodnie  
 Trouser and tie rack J04  
 Вешалка J04 для брюк и галстуков

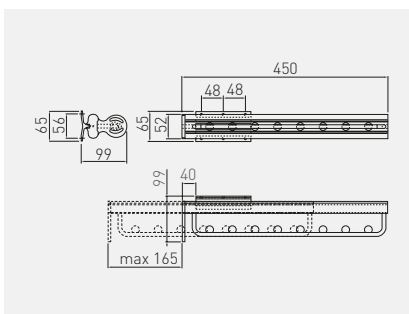

				
WW-K0AJ04-01	lewy / prawy left / right левый / правый	niepełny partial неполное	aluminium, czarny aluminium, black алюминий, чёрный	stal, aluminium, tworzywo steel, aluminium, plastic сталь, алюминий, пластмасса





Wieszak WU na ubrania  
 Clothes hanger WU  
 Вешалка WU для одежды

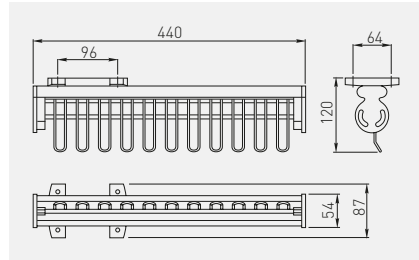

			
WW-WUBR00-01	niepełny partial неполное	chrom, aluminium, czarny chrome +aluminium, black хром, алюминий, чёрный	stal, aluminium, tworzywo steel, aluminium, plastic сталь, алюминий, пластмасса

Wieszak K0 na paski  
Hanger for belts K0  
Вешалка K0 для ремней



				
WW-PASEK0-05	lewy / prawy left / right левый / правый	niepełny partial неполное	chrom, aluminium, czarny chrome +aluminium, black хром, алюминий, чёрный	stal, aluminium, tworzywo steel, aluminium, plastic сталь, алюминий, пластмасса



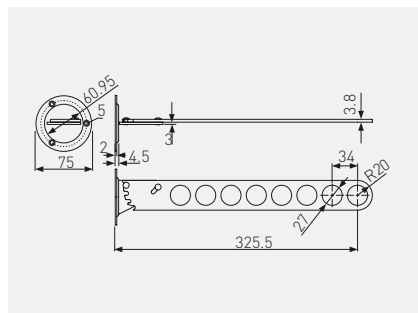

Wieszak SE  
Hanger SE  
Вешалка SE

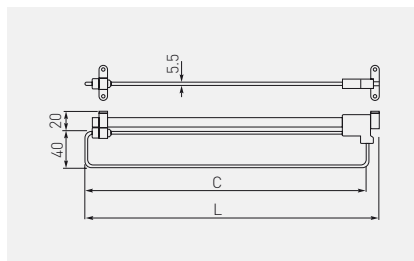

		
WW-SE0102-01	chrom chrome хром	stal steel сталь





Wieszak WSL  
Hanger WSL  
Вешалка WSL

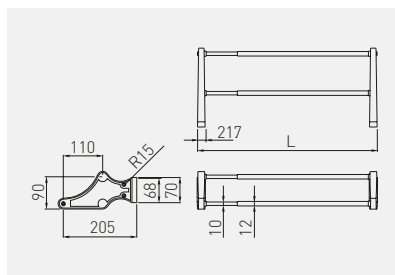

		 C mm	 L mm		
WW-WSL250-01		235	250	chrom chrome хром	stal steel сталь
WW-WSL300-01		285	300		
WW-WSL350-01		335	350		
WW-WSL400-01		385	400		
WW-WSL450-01		435	450		
WW-WSL500-01		485	500		

Półka na obuwie  
Shoe rack  
Полка для обуви



		 L mm		
PP-P04570-20		415-700	chrom, aluminium, czarny chrome, aluminium, black хром, алюминий, чёрный	stal, aluminium, tworzywo steel, aluminium, plastic сталь, алюминий, пластмасса
PP-P80110-20		715-1100	chrom, czarny chrome, black хром, чёрный	stal, tworzywo steel, plastic сталь, пластмасса



Zawias do półki na obuwie  
Hinge for shoe rack  
Крепление для полки под обувь

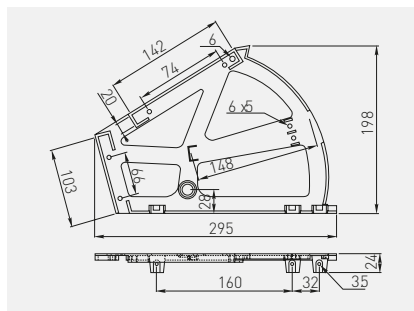

Zastosowanie dla płyty 12 mm  
For 12 mm board  
Крепление к плите 12 мм

WW-ZWBUT2-10	biały / white / белый	tworzywo plastic пластмасса
WW-ZWBUT2-20	czarny / black / чёрный	



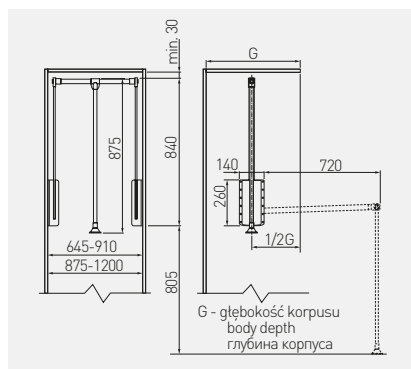

Pantograf z podnośnikiem gazowym  
Pull-down wardrobe rail - gas  
Пантограф с газовым подъемником

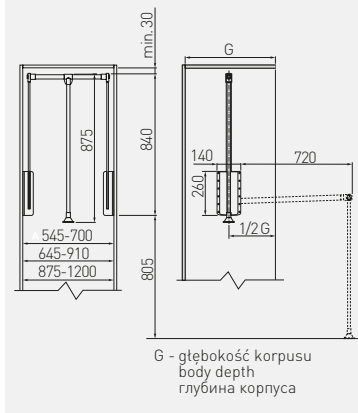

PG-GA6083-10	od 645 do 910	12	biały / white / белый	stal, tworzywo steel, plastic сталь, пластмасса
PG-GA6083-20			czarny / black / чёрный	
PG-GA8311520	od 875 do 1200			

Pantograf z podnośnikiem olejowym  
 Pull-down wardrobe rail - oil  
 Пантограф с масляным подъемником



	 mm	 kg		
PG-AL4560-20	od 545 do 700	8	aluminium / aluminium / алюминий	aluminium, tworzywo aluminium, plastic алюминий, пластмасса
PG-AL6083-20	od 645 do 910		aluminium / aluminium / алюминий	
PG-AL8311520	od 875 do 1200		aluminium / aluminium / алюминий	
PG-ST4560-10	od 545 do 700		biały / white / белый	stal, tworzywo steel, plastic сталь, пластмасса
PG-ST4560-20			czarny / black / чёрный	
PG-ST6083-10	od 645 do 910		biały / white / белый	
PG-ST6083-20			czarny / black / чёрный	
PG-ST83115-10	od 875 do 1200		biały / white / белый	
PG-ST8311520		czarny / black / чёрный		

Segregator PRACTI ECO 300  
 Trash bin PRACTI ECO 300  
 Сегрегатор PRACTI ECO 300



PB-45-0010X3



PB-45-002010

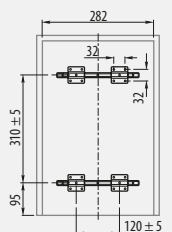
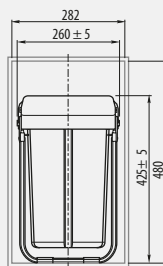
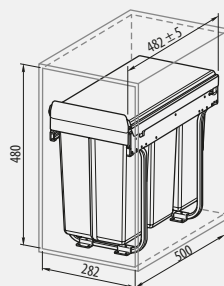

Na prowadnicy kulkowej H=45 z cichym domykiem  
 On ball bearing slide H=45 with soft closing  
 На шариковой направляющей H=45 с доводчиком



PB-45-0010X3	300	3 x 10 L	szary / gray / серый	tworzywo / plastic / пластмасса
PB-45-002010	300	10 L, 20 L		

Segregator PRACTI ECO 400  
 Trash bin PRACTI ECO 400  
 Сегрегатор PRACTI ECO 400



PB-45-002X20



PB-45-202X10

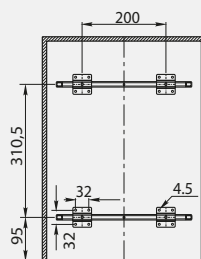
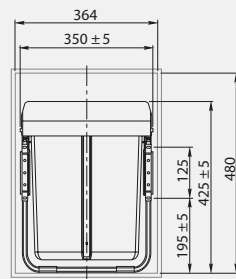
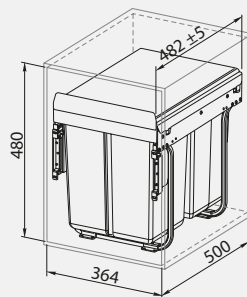

Na prowadnicy kulkowej H=45 z cichym domykaniem  
 On ball bearing slide H=45 with soft closing  
 На шариковой направляющей H=45 с доводчиком



PB-45-002X20	400	2 x 20 L	szary / gray / серый	tworzywo / plastic / пластмасса
PB-45-202X10	400	20 L, 2 x 10 L		

Segregator PRACTI ECO 400 z mocowaniem przednim  
 Trash bin PRACTI ECO 400 with door mount bracket  
 Сегрегатор PRACTI ECO 400 с передним креплением



PB-45M002S20



PB-45M202S10

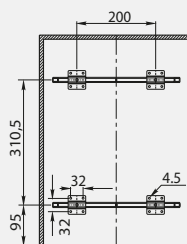
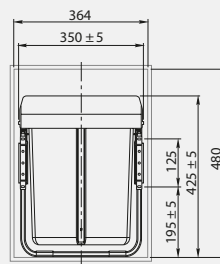
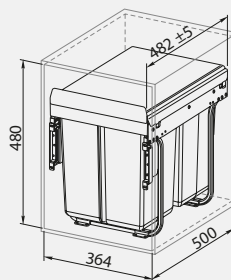

Na prowadnicy kulkowej H=45 z cichym domykiem  
 On ball bearing slide H=45 with soft closing  
 На шариковой направляющей H=45 с доводчиком



PB-45M002S20	400	2 x 20 L	szary / gray / серый	tworzywo / plastic / пластмасса
PB-45M202S10	400	20 L, 2 x 10 L		

Segregator PRACTI ECO 450 niski  
 Trash bin PRACTI ECO 450 low  
 Сегрегатор PRACTI ECO 450 низкий



PB-002X15-60MB

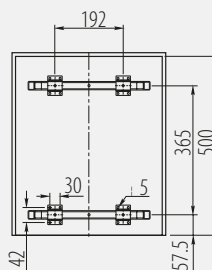
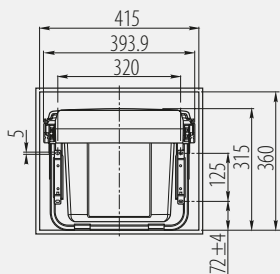
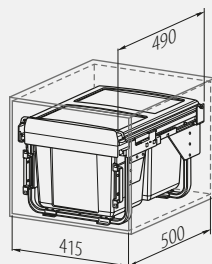

Na prowadnicy z cichym domykiem  
 On slide with soft closing  
 На направляющей с доводчиком



PB-002X15-60MB



450



2 x 15 L



szary / gray / серый



tworzywo / plastic / пластмасса

Segregator PRACTI ECO 450 niski z mocowaniem przednim  
 Trash bin PRACTI ECO 400 low with door mount bracket  
 Сегрегатор PRACTI ECO 400 низкий с передним креплением



PB-0M2S15-60MB

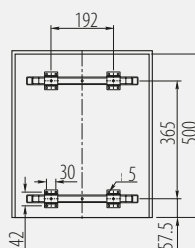
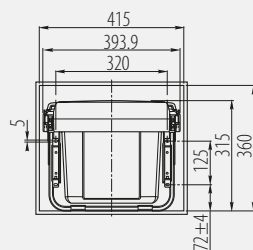
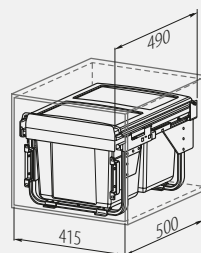

Na prowadnicy z cichym domykiem  
 On slide with soft closing  
 На направляющей с доводчиком



PB-0M2S15-60MB



450



2 x 15 L



szary / gray / серый



tworzywo / plastic / пластмасса

Segregator PRACTI ECO 450 wysoki  
 Trash bin PRACTI ECO 450 high  
 Сегрегатор PRACTI ECO 400 высокий



PB-002X20-60MB



PB-0202X1060MB

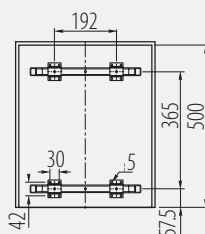
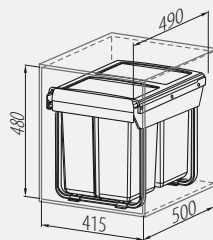
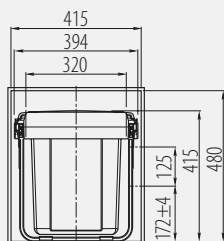

Na prowadnicy z cichym domykiem  
 On slide with soft closing  
 На направляющей с доводчиком



PB-002X20-60MB	450	2 x 20 L	szary / gray / серый	tworzywo / plastic / пластмасса
PB-0202X1060MB	450	20 L, 2 x 10 L		



Segregator PRACTI ECO 450 wysoki z mocowaniem przednim  
 Trash bin PRACTI ECO 450 high with door mount bracket  
 Сегрегатор PRACTI ECO 450 высокий с передним креплением



PB-M202X1060MB



PB-0M2S20-60MB

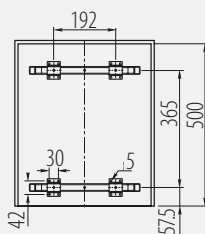
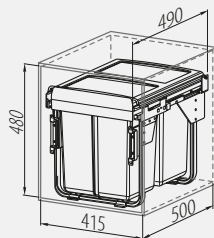
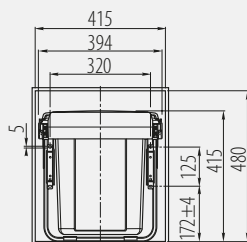

Na prowadnicy z cichym domykaniem  
 On slide with soft closing  
 На направляющей с доводчиком



PB-M202X1060MB	450	20 L, 2 x 10 L	szary / gray / серый	tworzywo / plastic / пластмасса
PB-0M2S20-60MB	450	2 x 20 L		

Segregator PRACTI ECO 600 wysoki z mocowaniem przednim  
 Trash bin PRACTI ECO 600 high with door mount bracket  
 Сегрегатор PRACTI ECO 600 высокий с передним креплением



PB-M342X1760MB



PB-0M2X34-60MB

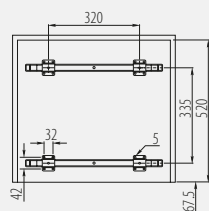
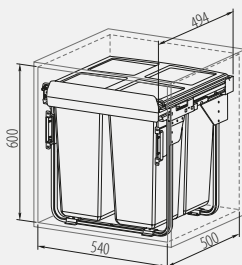
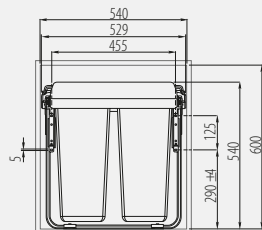

Na prowadnicy z cichym domykiem  
 On slide with soft closing  
 На направляющей с доводчиком



PB-M342X1760MB	600	20 L, 2 x 10 L	szary / gray / серый	tworzywo / plastic / пластмасса
PB-0M2X34-60MB	600	2 x 20 L		

Kosz QUADRA  
Trash bin QUADRA  
Мусорная корзина QUADRA

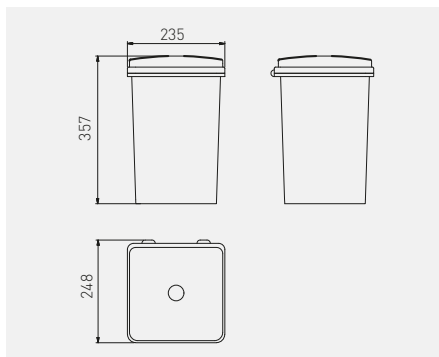

PB-91014100



13 L



szary / gray / серый



tworzywo / plastic / пластмасса

Kosz CIRCA  
Trash bin CIRCA  
Мусорная корзина CIRCA

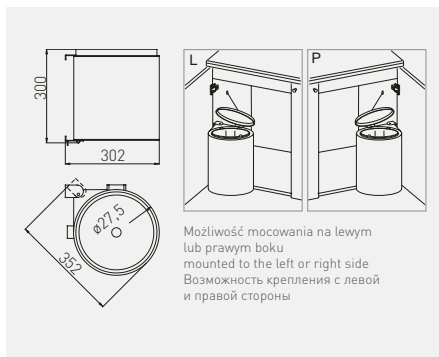

PB-91024160V



11 L



szary / gray / серый



tworzywo / plastic / пластмасса

Kosz ALTOLINO  
 Trash bin ALTOLINO  
 Мусорная корзина ALTOLINO



Możliwość mocowania na lewym lub prawym boku  
 Can be mounted to the left or right side  
 Возможность крепления с левой и правой стороны

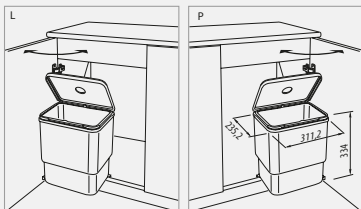

Wymiary montażowe  
 Mounting dimensions / Монтажные размеры

Sposób montażu  
 Instruction of installation / Способ монтажа

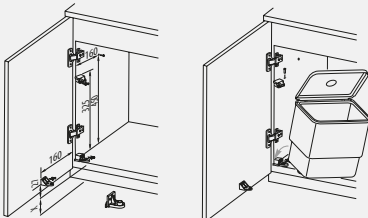

X - odległość od podłogi do górnej krawędzi wieszaka  
 x - distance from the floor to bottom of cabinet  
 x - расстояние между полом и плоскостью дна шкафа

Podwieszenie pokrywki  
 Suspension cover / Крепление крышки

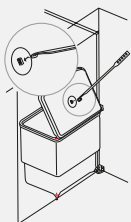

PB-90114100



11 L



szary / gray / серый



tworzywo / plastic / пластмасса

Segregator TIRA 350 plus  
 Trash bin TIRA 350 plus  
 Сегрегатор TIRA 350 plus

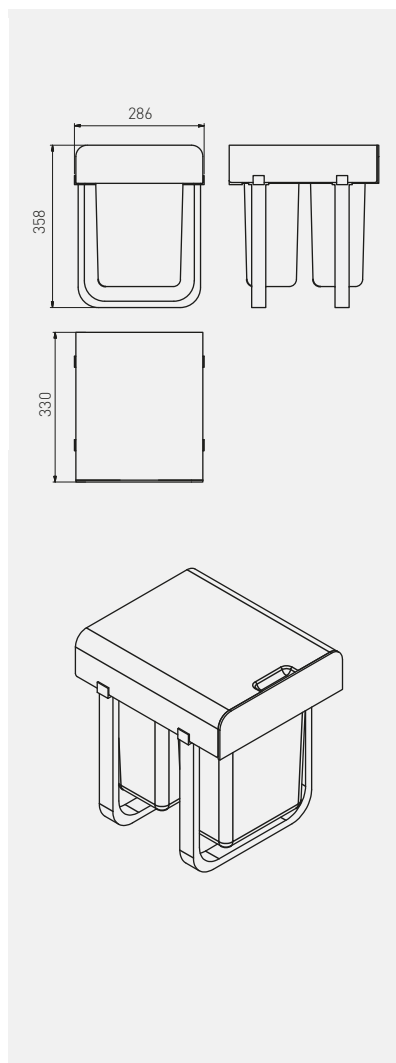

PB-90144100PCT



mm

od 350



2 x 8 L



szary / gray / серый



tworzywo / plastic / пластмасса

Segregator FORZA 400 plus  
 Trash bin FORZA 400 plus  
 Сепаратор FORZA 400 plus



PB-90934100PCT



PB-90954100PCT

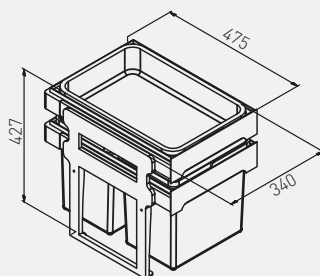
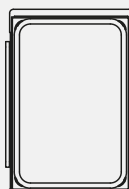
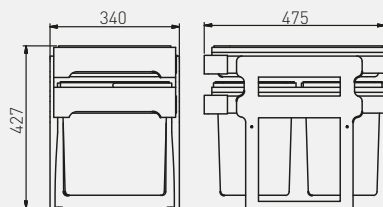

PB-90934100PCT	od 400	2 x 16 L	szary / gray / серый	tworzywo / plastic / пластмасса
PB-90954100PCT	od 400	1 x 16 L, 2 x 8 L		

Segregator FORZA 400 z mocowaniem przednim  
 Trash bin FORZA with door mount bracket  
 Сегрегатор FORZA с передним креплением







PB-91474100PCT

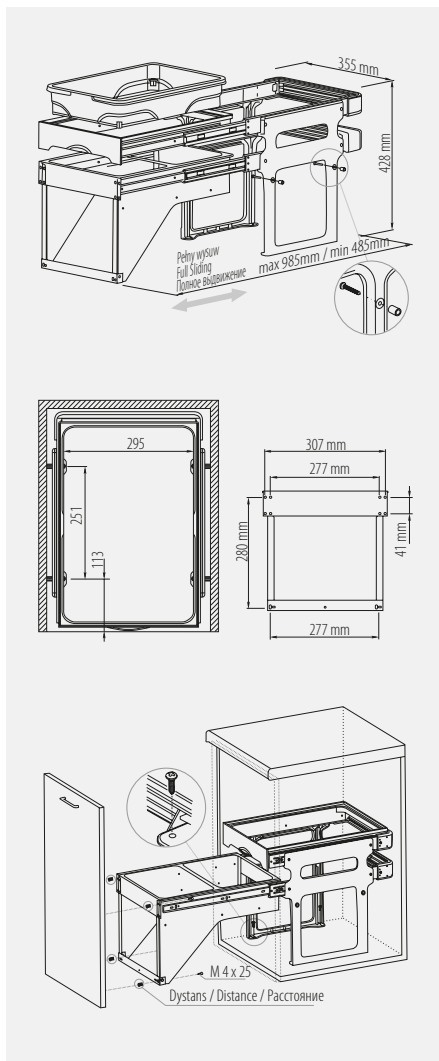

PB-91464100PCT



					
PB-91464100PCT	400	2 x 16 L		szary / gray / серый	tworzywo / plastic / пластмасса
PB-91474100PCT	400	1 x 16 L, 2 x 8 L			

## Segregator UNITO 600 Trash bin UNITO 600 Сегрегатор UNITO 600

Z mocowaniem przednim. Na prowadnicach z cichym domykiem  
With door mount bracket. On ball bearing slides with soft closing  
Крепление к фасаду. Направляющие с доводчиком

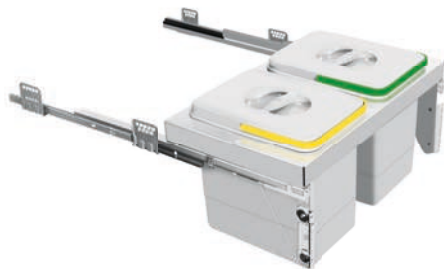



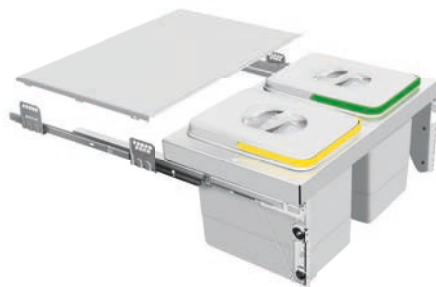

PB-91554160V

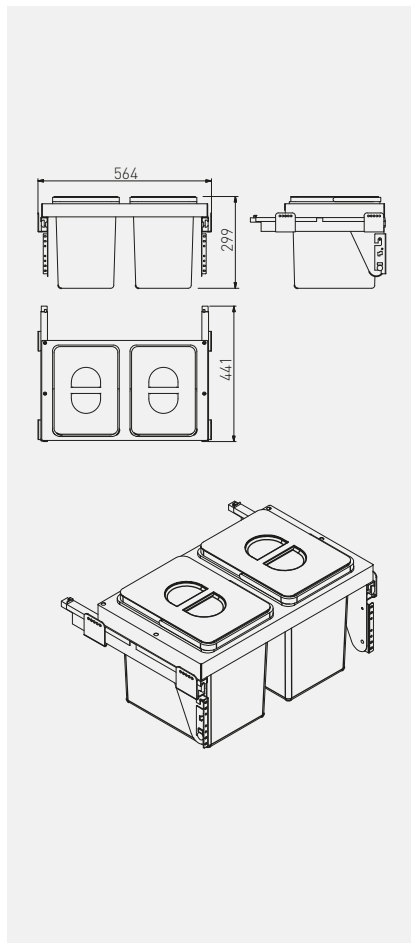

PB-91564160V



		 mm			
PB-91554160V	600	2 x 15 L	szary gray серый	tworzywo plastic пластмасса	
PB-91564160V	600	2 x 15 L, pokrywka / cover / крышка			



## Segregator MULTINO Trash bin MULTINO Сегрегатор MULTINO

Przeznaczone do szuflad Modern Box  
For Modern Box drawers  
Только для ящиков Modern Box



PB-91114100B5



PB-91104100B5



PB-91634100B5

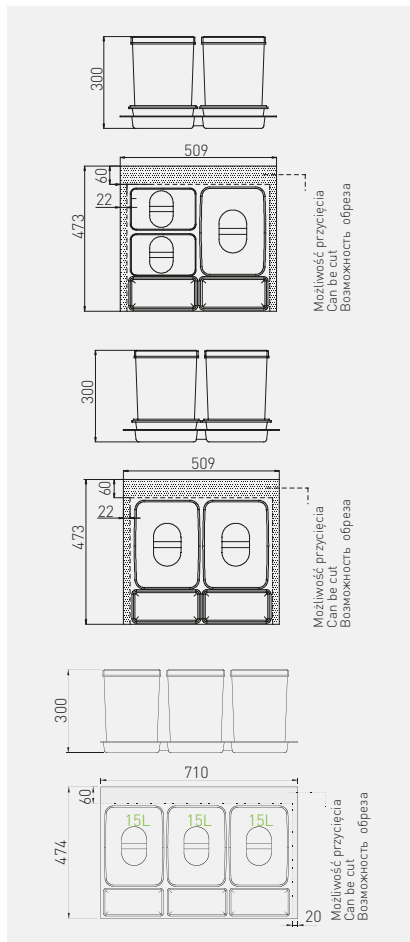

PB-91104100B5	600	2 x 15 L, 2 brytfanki / 3 tray storage spaces / наполнители	szary gray серый	tworzywo plastic пластмасса
PB-91114100B5	600	1 x 15 L, 2 x 7 L, 2 brytfanki / 3 tray storage spaces / наполнители		
PB-91634100B5	800	3 x 15 L		
PB-91644100B5	800	2 x 15L, 2 x 7 L		
PB-91164100B5	900	3 x 15 L, 3 brytfanki / 3 tray storage spaces / наполнители		
PB-91174100B5	900	2 x 15 L, 2 x 7, 3 brytfanki / 3 tray storage spaces / наполнители		

## Segregator MULTINO Trash bin MULTINO Сегрегатор MULTINO

Przeznaczone do szuflad Modern Box  
For Modern Box drawers  
Только для ящиков Modern Box



PB-91644100B5



PB-91174100B5



PB-91164100B5

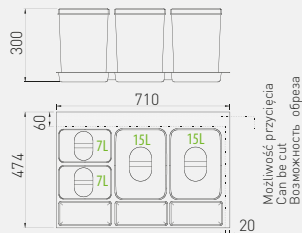

Segregator MULTINO 800 (bez przycinania) jest dopasowany do szuflady MODERN BOX NL=500 zamontowanej w korpusie LW=764\*

Without modifications, the MULTINO 800 trash bin is designed to fit MODERN BOX NL=500 drawer, mounted in a cabinet LW=764\*

Сегрегатор MULTINO 800 (без обреза) подходит к системе ящиков MODERN BOX NL=500, замонтированной в корпусе LW=746\*

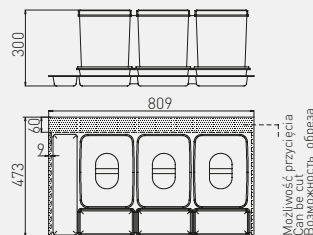
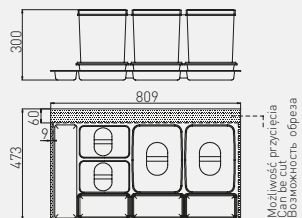

Corner standard  
 Corner standard  
 Выдвижная корзина, стандарт

Cichy domyk, mocowanie do frontu  
 Soft closing, door mounting bracket  
 Доводчик, крепление к фасаду

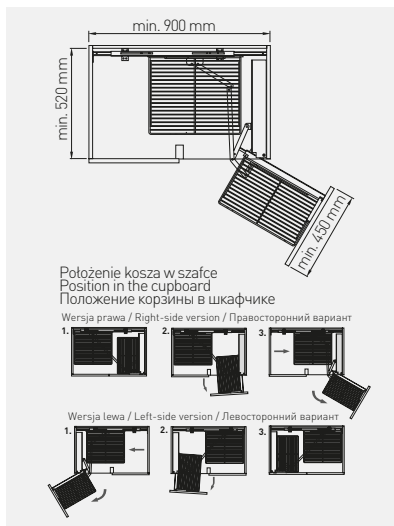
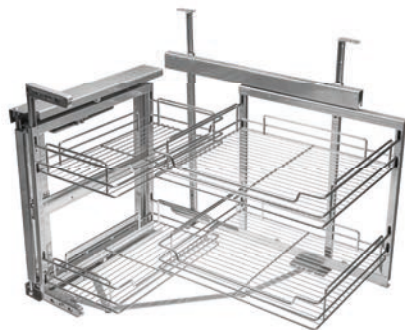

KO-UMC484SC	lewy / prawy left / right левый / правый	40	lakier, chrom lacquer, chrome лак, хром	chrom, srebrny chrome, silver хром, серебристый	stal steel сталь



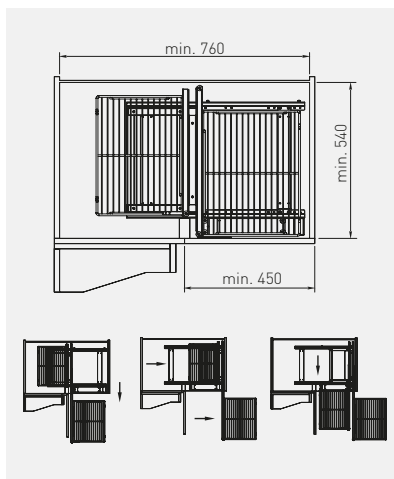



Corner DUO  
 Corner DUO  
 Корзина DUO

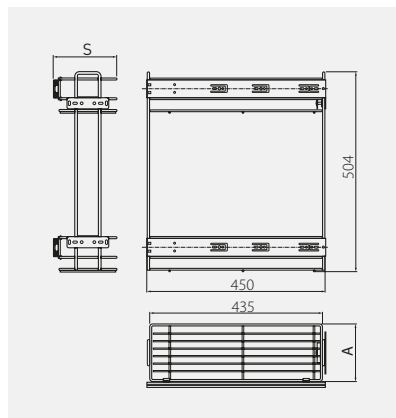

KO-UMC464SC	lewy / prawy left / right левый / правый	40	lakier, chrom lacquer, chrome лак, хром	chrom, srebrny chrome, silver хром, серебристый	stal steel сталь







Cargo boczne na prowadnicy kulkowej H45 ze spowalniczem  
 Side cargo on a H45 ball bearing slide with soft closing  
 Выдвижная корзина с боковым креплением на шариковых  
 направляющих H45 с механизмом плавного закрытия

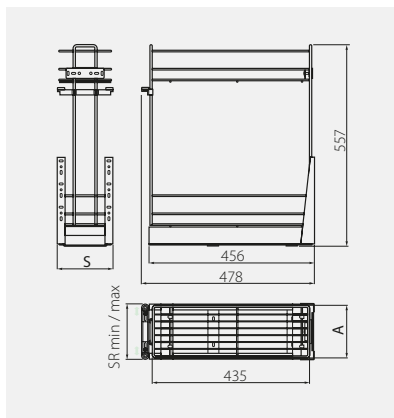

	 mm	 mm	 mm			
KO-1502B0-CR	150	95	110	ocynk galvanized гальваника	chrom chrome хром	stal steel сталь
KO-2002B0-CR	200	145	160			
KO-3002B0-CR	300	245	260			
KO-1502B0-10	150	95	110		biały white белый	
KO-2002B0-10	200	145	160			
KO-3002B0-10	300	245	260			
KO-1502B0-SR	150	95	110		srebrny silver серебристый	
KO-2002B0-SR	200	145	160			
KO-3002B0-SR	300	245	260			

Cargo dolne na prowadnicy kulkowej H45 ze spowalniczem  
 CARGO LOWER ball bearing slide H45 with soft close system  
 Выдвижная корзина для нижних шкафов на шариковых  
 направляющих H45 с механизмом плавного закрытия







		 mm	 mm	 mm			
KO-1502MD-CR	150	95	104	осынок galvanized гальваника	chrom chrome хром	stal steel сталь	
KO-2002MD-CR	200	145	154				
KO-3002MD-CR	300	245	254				
KO-4002MD-CR	400	345	345				
KO-5002MD-CR	500	445	445				
KO-6002MD-CR	600	545	554				
KO-1502MD-SR	150	95	104		srebrny silver серебристый		
KO-2002MD-SR	200	145	154				
KO-3002MD-SR	300	245	254				
KO-4002MD-SR	400	345	345				
KO-5002MD-SR	500	445	445				
KO-6002MD-SR	600	545	554				

Cargo boczne na prowadnicy kulkowej H35

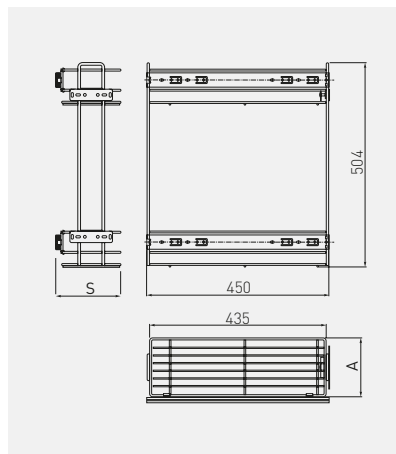
Side cargo on a H35 ball bearing slide

Выдвижная корзина с боковым креплением на шариковых направляющих H35



	 mm	 mm	 mm			
KO-CMB150-PW-01	150	95	110	осунк galvanized гальваника	chrom chrome хром	stal steel сталь
KO-CMB200-PW-01	200	145	160			
KO-CMB300-PW-01	300	245	260			
KO-CMB150-PW-10	150	95	110		biały white белый	
KO-CMB200-PW-10	200	145	160			
KO-CMB300-PW-10	300	245	260			
KO-CMB150-PW-0C	150	95	110		srebrny silver серебристый	
KO-CMB200-PW-0C	200	145	160			
KO-CMB300-PW-0C	300	245	260			

Ociekarka dwupoziomowa do montażu  
Two tier dish drying rack  
Двухуровневая сушилka для посуды (монтаж)



OC-A0150-06	stal szczotkowana brushed steel шлифованная сталь	stal steel сталь
OC-A0160-06		
OC-A0170-06		
OC-A0180-06		
OC-A0190-06		

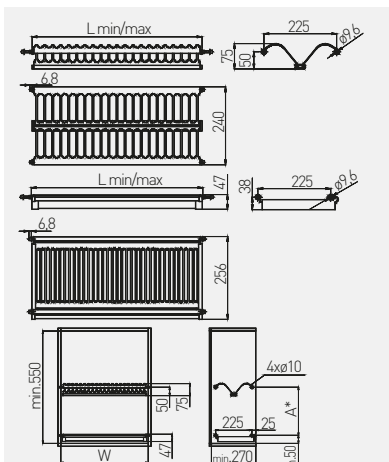

A\* wymiar zależny od wysokości szafki i planowanego zagospodarowania (np. A=275mm)  
A\* dimension depends on the height of the cabinet and space planning (e.g. A=275mm)  
A\* размер зависит от высоты шкафа и планировки внутреннего пространства (напр. A=275мм)

L min./max	W min./max
430 / 480	450/475
530 / 580	550/575
630 / 680	650/675
730 / 780	750/775
830 / 880	850/875

Ociekarka jednopoziomowa do montażu  
Dish drying rack  
Сушилka для посуды (монтаж)





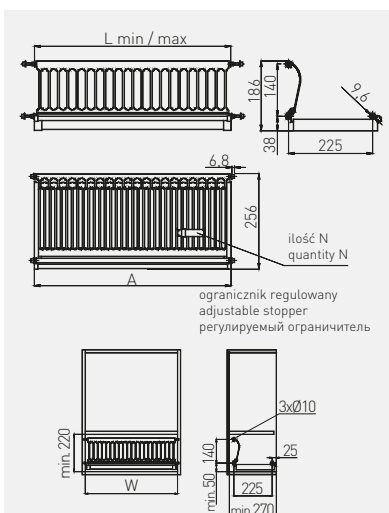



OC-A0660-06	stal szczotkowana brushed steel шлифованная сталь	stal steel сталь
OC-A0680-06		

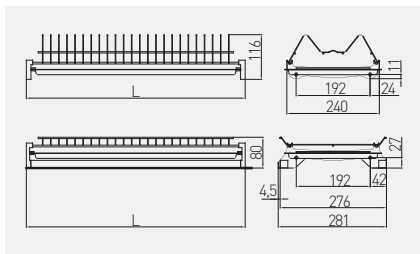
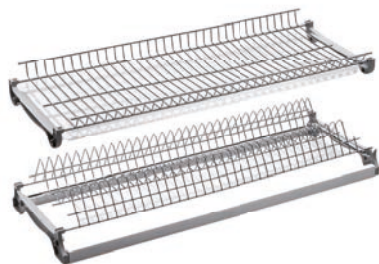

L min/max	L min/max	N
530 / 580	550/575	6
730 / 780	750/775	8

Осiekarka dwupoziomowa do montažu  
Two tier dish drying rack  
Двухуровневая сушилka для посуды (встраиваемая)



		 mm		
OC-2PV340-01	do płyty 16 mm for 16mm board для поверхности 16 мм	364	chrom chrome хром	stal, tworzywo steel, plastic сталь, пластмасса
OC-2PV350-01		464		
OC-2PV360-01		564		
OC-2PV370-01		664		
OC-2PV380-01		764		
OC-2PV390-01		864		
OC-2PV340-01-18	do płyty 18 mm for 18mm board для поверхности 18 мм	368		
OC-2PV350-01-18		468		
OC-2PV360-01-18		568		
OC-2PV370-01-18		668		
OC-2PV380-01-18		768		
OC-2PV390-01-18		868		



Ociekarka dwupoziomowa A04, wolnostojąca

Two tier Dish drying rack A04

Сушилка для посуды настольная A04, двухуровневая

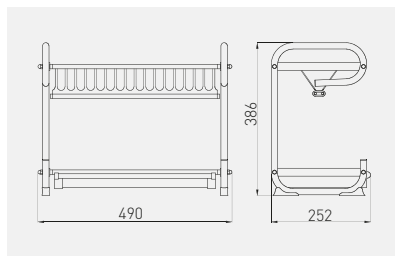

OC-A0450-06



stal szorstkowana  
brushed steel  
шлифованная сталь



stal  
steel  
сталь

Ociekarka dwupoziomowa A03, wolnostojąca

Two tier Dish drying rack A03

Сушилка для посуды настольная A03, двухуровневая

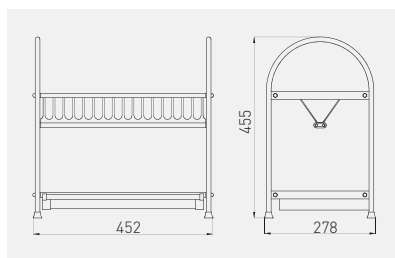

OC-A0350K-06



stal szorstkowana  
brushed steel  
шлифованная сталь



stal  
steel  
сталь

Ociekarka dwupoziomowa z organizerem, wolnostojąca

Two tier Dish drying rack with organizer

Сушилка для посуды и столовых приборов настольная, двухуровневая

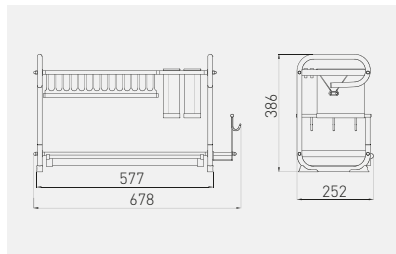

OC-A0460D-06



stal szorstkowana  
brushed steel  
шлифованная сталь



stal  
steel  
сталь

Ociekarka zwijana

Roll-up drying rack

Складная сушилка

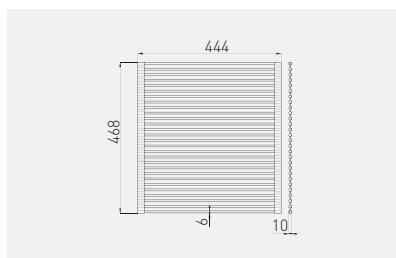
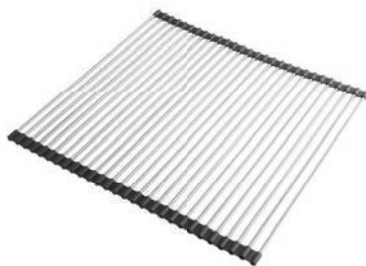

OC-E0707D-CZ



stal szorstkowana, czarny  
brushed steel, black  
шлифованная сталь, чёрный





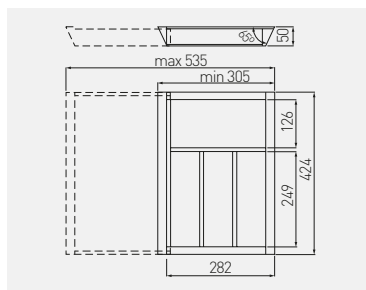

stal  
steel  
сталь

## Wkład CUSTOMI A regulowany Adjustable cutlery organizer CUSTOMI A Вкладыш для столовых приборов с возможностью регулировки CUSTOMI



Maksymalny wysuw = 535 mm  
Maximum extension = 535 mm  
Максимальное выдвижение = 535 мм

Do szuflad Modern Box i Axis L450  
For Modern Box or Axis L=450 mm  
Подходит для ящиков Modern Box/Axis L=450 мм



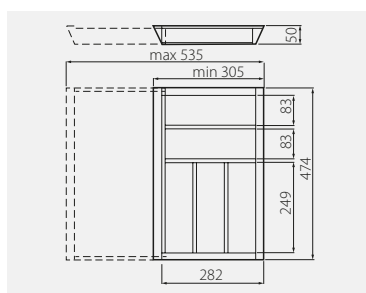

	 mm			
W-CUSTOMI-60L450	424 x 305	lakier bezbarwny matowy clearcoat matt surface лак матовый бесцветный	buk beech бук	drewno buk beech wood дерево бука

## Wkład CUSTOMI BIS A regulowany Adjustable cutlery organizer CUSTOMI BIS A Вкладыш для столовых приборов с возможностью регулировки CUSTOMI



Maksymalny wysuw = 535 mm  
Maximum extension = 535 mm  
Максимальное выдвижение = 535 мм

Do szuflad Modern Box i Axis L500  
For Modern Box or Axis L=500 mm  
Подходит для ящиков Modern Box/Axis L=500 мм

	 mm			
W-CUSTOMI-60L500	474 x 305	lakier bezbarwny matowy clearcoat matt surface лак матовый бесцветный	buk beech бук	drewno buk beech wood дерево бука

Wkład CUSTOMI B regulowany  
Adjustable cutlery organizer CUSTOMI B  
Вкладыш для столовых приборов с возможностью регулировки

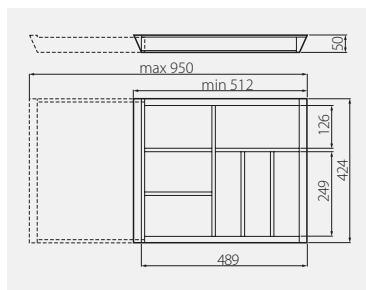

Maksymalny wysuw = 950 mm  
Maximum extension = 950 mm  
Максимальное выдвижение = 950 мм

Do szuflad Modern Box i Axis L450  
For Modern Box or Axis L=450 mm  
Подходит для ящиков Modern Box/Axis L=450 мм

				
W-CUSTOMI-80L450	512 x 424	lakier bezbarwny matowy clearcoat matt surface лак матовый бесцветный	buk beech бук	drewno buk beech wood дерево бука

Wkład CUSTOMI BIS B regulowany  
Adjustable cutlery organizer CUSTOMI BIS B  
Вкладыш для столовых приборов с возможностью регулировки

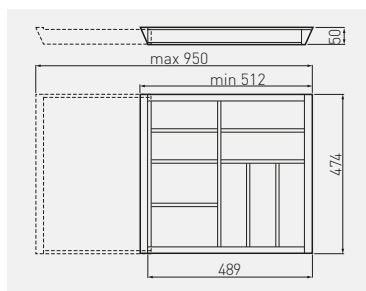

Maksymalny wysuw = 950 mm  
Maximum extension = 950 mm  
Максимальное выдвижение = 950 мм



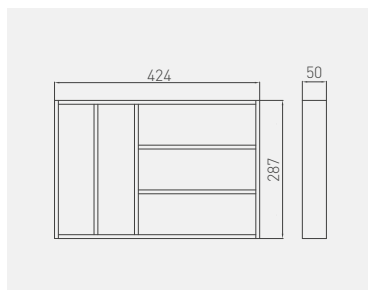

Do szuflad Modern Box i Axis L500  
For Modern Box or Axis L=500 mm  
Подходит для ящиков Modern Box/Axis L=500 мм

				
W-CUSTOMI-80L500	512 x 474	lakier bezbarwny matowy clearcoat matt surface лак матовый бесцветный	buk beech бук	drewno buk beech wood дерево бука

Wkład INSERTI A  
Cutlery organizer INSERTI A  
Универсальный вкладыш для столовых приборов





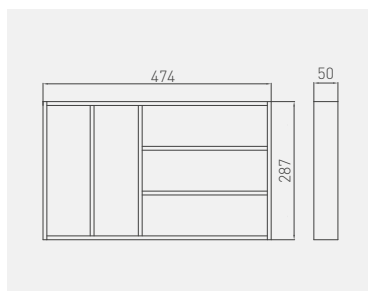

Do szuflad Modern Box i Axis L450  
For Modern Box or Axis L=450 mm  
Подходит для ящиков Modern Box/Axis L=450 мм

	 mm			
W-INSERTI-L450	424 x 287	lakier bezbarwny matowy clearcoat matt surface лак матовый бесцветный	buk beech бук	drewno buk beech wood дерево бука

Wkład INSERTI B  
Cutlery organizer INSERTI B  
Универсальный вкладыш для столовых приборов



Do szuflad Modern Box i Axis L500  
For Modern Box or Axis L=500 mm  
Подходит для ящиков Modern Box/Axis L=500 мм

	 mm			
W-INSERTI-L500	474 x 287	lakier bezbarwny matowy clearcoat matt surface лак матовый бесцветный	buk beech бук	drewno buk beech wood дерево бука

**Blok KNIFI na noże**

Knife block for KNIFI

Вставка для ножей (для использования с вкладышами CUSTOMI)

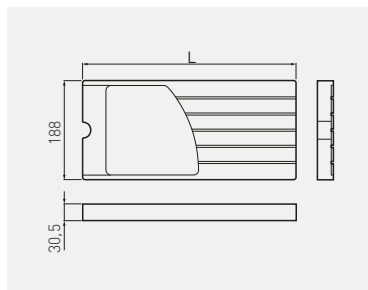

				
W-AKC-KNIFI-L450	405	lakier bezbarwny matowy clearcoat matt surface лак матовый бесцветный	buk beech бук	drewno buk beech wood дерево бука
W-AKC-KNIFI-L500	455			

**Blok HERBI na przyprawę**

Spice tray HERBI

Вставка для специй (для использования с вкладышами CUSTOMI)

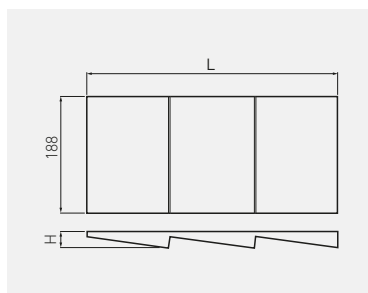

					
W-AKC-HERBI-L450	405	24	lakier bezbarwny matowy clearcoat matt surface лак матовый бесцветный	buk beech бук	drewno buk beech wood дерево бука
W-AKC-HERBI-L500	455	26			

Uchwyt HOLDI na folię  
 Foil roll dispenser HOLDI  
 Вставка HOLDI для фольги и пленки

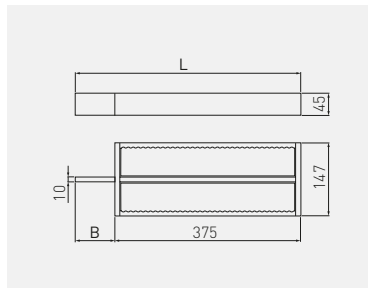

	 mm			
W-AKC-HOLDI-L450	405 x 147	lakier bezbarwny matowy clearcoat matt surface	buk beech	drewno buk beech wood
W-AKC-HOLDI-L500	455 x 147	лак матовый бесцветный	бук	дерево бука

Mata antypoślizgowa do szuflad  
 Anti-slip mat for drawers  
 Противоскользящий коврик для ящиков



	 mm		
MA-MATA-0-00	1500 x 470	przeźroczysty transparent	tworzywo plastic
		прозрачный	пластмасса

Półka pod klawiaturę z prowadnicą kulkową 27 mm

Keyboard shelf with 27mm drawer slide

Полка для клавиатуры с шариковой направляющей 27 мм

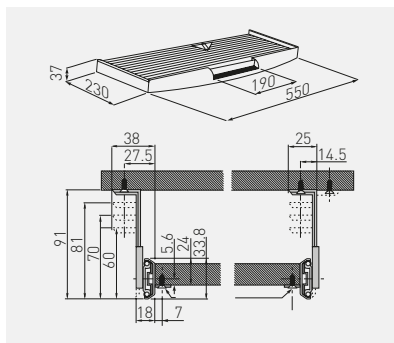

PU-KEY027-20	czarny / black / чёрный	tworzywo plastic пластмасса
PU-KEY027-60	szary / gray / серый	

Półka pod klawiaturę z podkładką na myszkę

Keyboard shelf with mouse pad

Полка для клавиатуры с подставкой для мыши

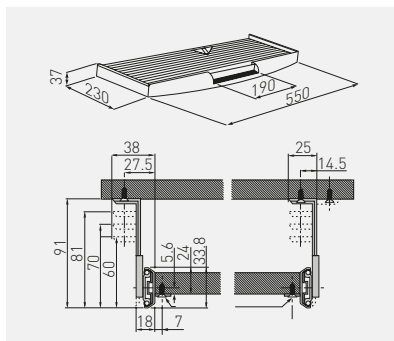

PU-KEYM27-20	czarny / black / чёрный	tworzywo plastic пластмасса
PU-KEYM27-60	szary / gray / серый	



Wózek pod komputer  
Computer trolley  
Передвижная подставка под компьютер

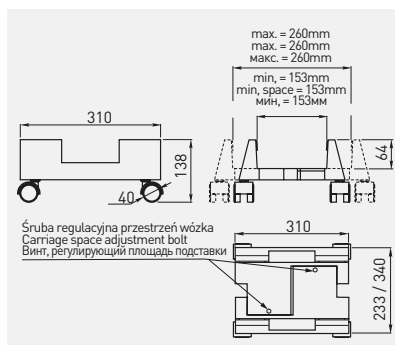

PU-PKO-00-20	czarny / black / чёрный	tworzywo plastic пластмасса
PU-PKO-00-60	szary / gray / серый	

Hub - 4 porty USB  
Hub -4 USB ports  
Удлинитель на 4 входа USB

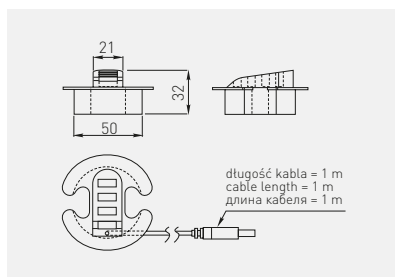

HB-USB-4X-20	czarny / black / чёрный	tworzywo plastic пластмасса
HB-USB-4X-60	srebrny / silver / серебряный	

Przepust MERIDA 80  
 Desk cable outlet MERIDA 80  
 Пропуск для кабеля MERIDA 80

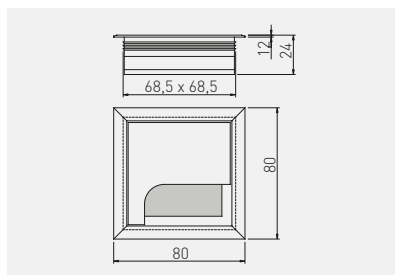

	 mm		
LB-K80X80-05	80 x 80	aluminium / aluminium / алюминий	aluminium
LB-K80X80-20		czarny / black / чёрный	aluminium aluminium алюминий

Przepust MERIDA 100  
 Desk cable outlet MERIDA 100  
 Пропуск для кабеля MERIDA 100

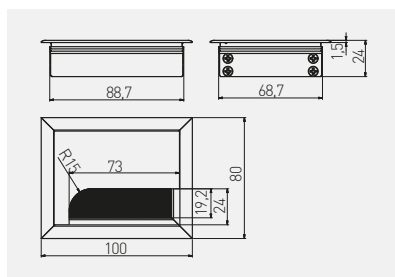

	 mm		
LB-K80X100-05	80 x 100	aluminium / aluminium / алюминий	aluminium
LB-K80X100-20		czarny / black / чёрный	aluminium aluminium алюминий

Przepust MERIDA 160  
 Desk cable outlet MERIDA 160  
 Пропуск для кабеля MERIDA 160

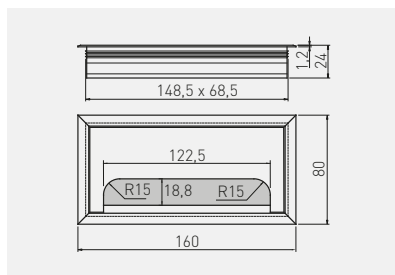

	 mm		
LB-80X160-05	80 x 160	aluminium / aluminium / алюминий	aluminium
LB-80X160-20		czarny / black / чёрный	aluminium aluminium алюминий

Przepust MERIDA 280  
 Desk cable outlet MERIDA 280  
 Пропуск для кабеля MERIDA 280

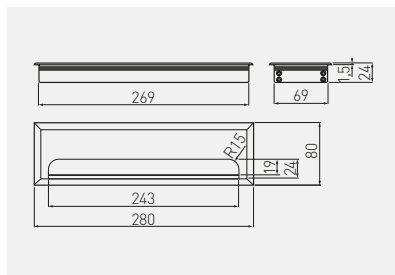

	 mm		
LB-80X280-05	80 x 280	aluminium / aluminium / алюминий	aluminium
LB-80X280-20		czarny / black / чёрный	aluminium aluminium алюминий



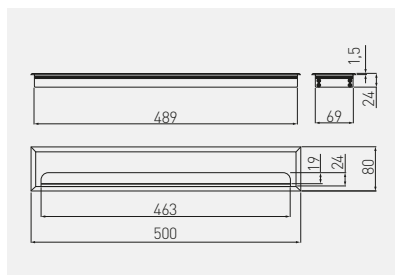

Przepust MERIDA 500  
 Desk cable outlet MERIDA 500  
 Пропуск для кабеля MERIDA 500

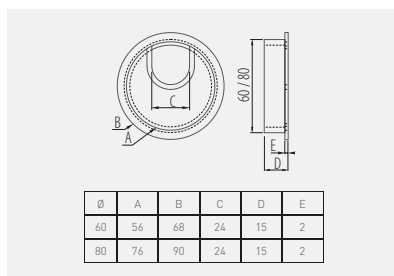

			
LB-80X500-05	80 x 500	aluminium / aluminium / алюминий	aluminium
LB-80X500-20		czarny / black / чёрный	aluminium aluminium алюминий

Przepust LBF  
 Desk cable grommet LBF  
 Пропуск для кабеля LBF



			
PM-LBF160-01	60	chrom / chrome / хром	ZnAl
PM-LBF160-02		satyna / satin / сатин	
PM-LBF160-05		aluminium / aluminium / алюминий	
PM-LBF160-06	stal szczotkowana / brushed steel / шлифованная сталь		
PM-LBF180-01	80	chrom / chrome / хром	
PM-LBF180-02		satyna / satin / сатин	
PM-LBF180-05		aluminium / aluminium / алюминий	
PM-LBF180-06		stal szczotkowana / brushed steel / шлифованная сталь	



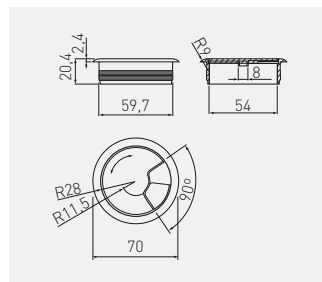

Przepust PLF  
 Desk cable grommet PLF  
 Пропуск для кабеля PLF

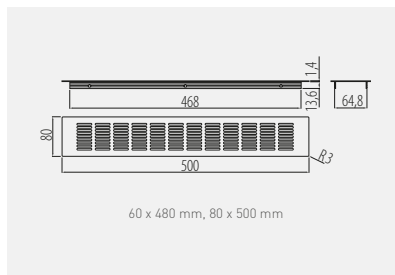

		
PM-PLFI60-02	satyna / satin / сатин	tworzywo plastic пластмасса
PM-PLFI60-05	aluminium / aluminium / алюминий	
PM-PLFI60-10	biały / white / белый	
PM-PLFI60-20	czarny / black / черный	
PM-PLFI60-30	popiel / gray / серый	
PM-PLFI60-41	olcha / alder / ольха	
PM-PLFI60-42	grusza / pear / груша	
PM-PLFI60-43	jasny brąz / light brown / светло-коричневый	
PM-PLFI60-44	buk / beech / бук	
PM-PLFI60-45	orzech / walnut / цвет орех	
PM-PLFI60-46	rustikal / rustical / рустикал	
PM-PLFI60-47	buk / beech / бук	
PM-PLFI60-48	mahoń / mahogany / красное дерево	
PM-PLFI60-49	klon / maple / клен	
PM-PLFI60-50	beż / beige / бежевый	
PM-PLFI60-51	kalwados / calvados / кальвадос	
PM-PLFI60-52	wiśnia / cherry / вишня	
PM-PLFI60-58	wenge / venge / венге	





Kratka wentylacyjna D50-80  
Plinth vent D50-80  
Вентиляционная решётка D50-80

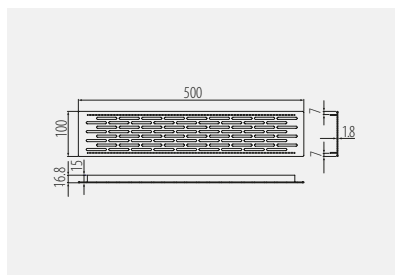

			
KK-D50-80-06	Przepustowość powietrza - 108 cm <sup>2</sup> Air throughput - 108 cm <sup>2</sup> Прохождение воздушного потока - 108 см <sup>2</sup>	stal szczotkowana brushed steel шлифованная сталь	aluminium aluminium алюминий

Kratka wentylacyjna D50-100  
Plinth vent D50-100  
Вентиляционная решётка D50-100



			
KK-D50100-06	Przepustowość powietrza - 130 cm <sup>2</sup> Air throughput - 130 cm <sup>2</sup> Прохождение воздушного потока - 130 см <sup>2</sup>	stal szczotkowana brushed steel шлифованная сталь	aluminium aluminium алюминий

Kratka wentylacyjna W60  
Plinth vent W60  
Вентиляционная решётка W60

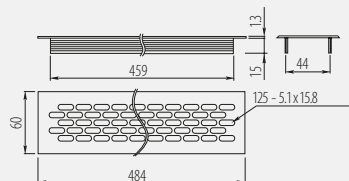

KK-W60800-M0	Przepustowość powietrza - 94 cm <sup>2</sup> Air throughput - 94 cm <sup>2</sup>	szary / grey / серый	aluminium aluminium алюминий
KK-W60800-M1	Прохождение воздушного потока - 94 см <sup>2</sup>	biały / white / белый	

Kratka wentylacyjna W80  
Plinth vent W80  
Вентиляционная решётка W80

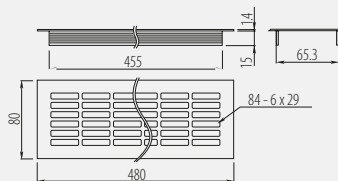
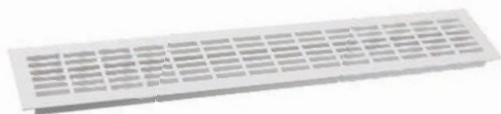

KK-W80800-D0	Przepustowość powietrza - 146 cm <sup>2</sup> Air throughput - 146 cm <sup>2</sup>	szary / grey / серый	aluminium aluminium алюминий
KK-W80800-D1	Прохождение воздушного потока - 146 см <sup>2</sup>	biały / white / белый	

Obrotnica okrągła  
Round swivel bracket  
Круглый поворотный кронштейн

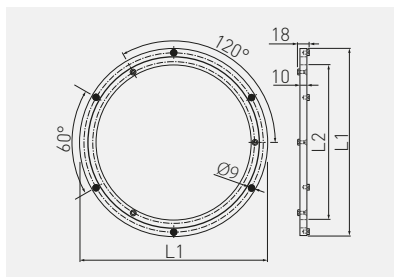

	 L1 mm	 L2 mm	 kg		
OM-OB0300-05	300	248	60	aluminium aluminium алюминий	aluminium aluminium алюминий
OM-OB0350-05	350	298	80		
OM-OB0400-05	400	338	100		

Obrotnica kwadratowa  
Square swivel bracket  
Поворотный кронштейн, квадратный

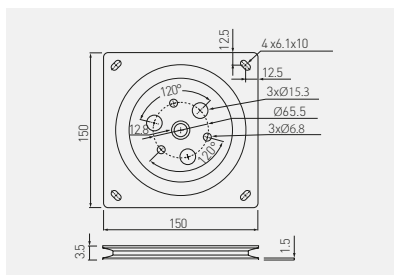

	 kg		
OM-OBK150-20	50	czarny black чёрный	stal steel сталь





**AKCESORIA DEKORACYJNE  
DECORATIVE ACCESSORIES  
ЛИЦЕВАЯ ФУРНИТУРА**

Uchwyty Handles Ручки	238 – 319
Wieszaki Hooks Крючки	320 – 332
Nóżki meblowe Furniture legs Мебельные ножки	333 – 360
Nogi meblowe Furniture legs Мебельные опоры	361 – 366
Rolki meblowe Furniture castors Мебельные ролики	367 – 371
Zamki meblowe Cabinet locks Замки	372 – 379

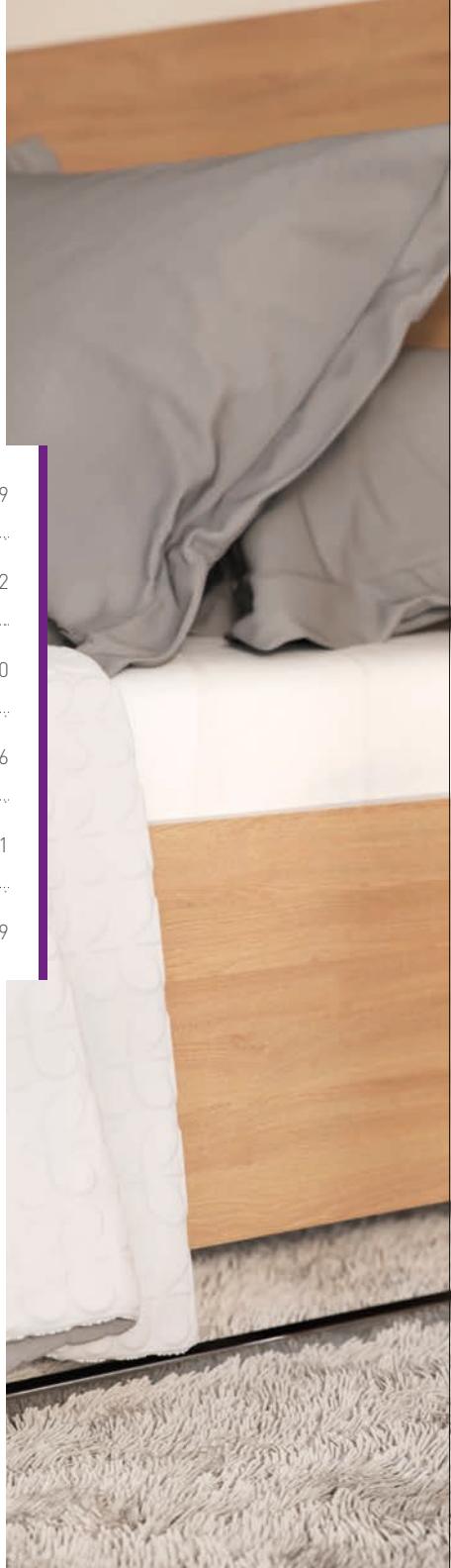



Uchwyt CLEO  
Handle CLEO  
Ручка CLEO



finalist  
of the competition



2017

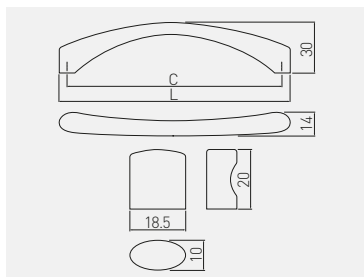

C mm	L mm				
		chrom chrome хром	aluminium aluminium алюминий	stal szczotkowana brushed steel шлифованная сталь	ZnAl
128	137	UZ-CLEO-128-01	UZ-CLEO-128-05	UZ-CLEO-128-06	
160	169	UZ-CLEO-160-01	UZ-CLEO-160-05	UZ-CLEO-160-06	
192	201	UZ-CLEO-192-01	UZ-CLEO-192-05	UZ-CLEO-192-06	
gatka knob ручка		GZ-CLEO-1-01	GZ-CLEO-1-05	GZ-CLEO-1-06	

Uchwyt SENIOR  
Handle SENIOR  
Ручка SENIOR





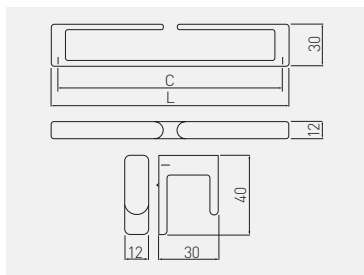
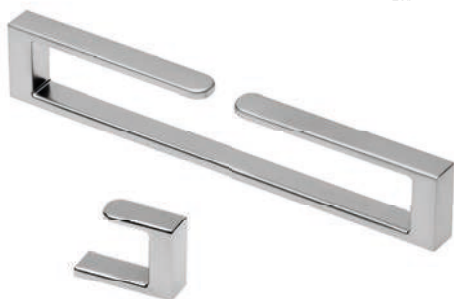

DIAMENT  
meblarstwa  
2017

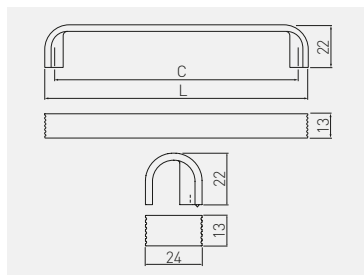

C mm	L mm				
		chrom chrome хром	aluminium aluminium алюминий		ZnAl
160	170	UZ-SENIOR-160-01	UZ-SENIOR-160-05		
gatka knob ручка		GZ-SENIOR-1-01	GZ-SENIOR-1-05		





Uchwyt VETA  
Handle VETA  
Ручка VETA

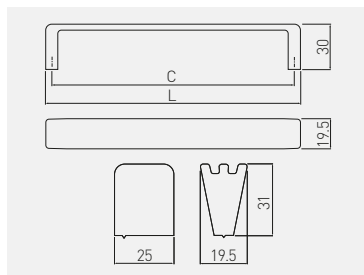

 C mm	 L mm				
		chrom chrome хром	aluminium aluminium алюминий	czarny chrom black chrome чёрный хром	ZnAl
128	138	UZ-VETA-128-01	UZ-VETA-128-05	UZ-VETA-128-12	
160	170	UZ-VETA-160-01	UZ-VETA-160-05	UZ-VETA-160-12	
320	330	UZ-VETA-320-01	UZ-VETA-320-05	UZ-VETA-320-12	
gatka knob ручка		GZ-VETA-1-01	GZ-VETA-1-05	GZ-VETA-1-12	

Uchwyt GANZA  
Handle GANZA  
Ручка GANZA



 C mm	 L mm					
		chrom chrome хром	aluminium aluminium алюминий	biały white белый	czarny chrom black chrome чёрный хром	ZnAl
160	168	UZ-GANZA-160-01	UZ-GANZA-160-05	UZ-GANZA-160-10	UZ-GANZA-160-12	
gatka knob ручка		GZ-GANZA-1-01	GZ-GANZA-1-05	GZ-GANZA-1-10	GZ-GANZA-1-12	

Uchwyt AGIOS  
Handle AGIOS  
Ручка AGIOS

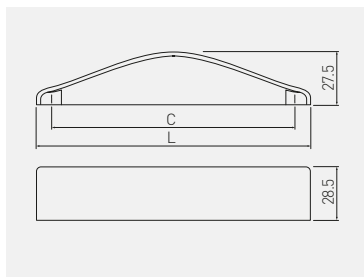

C mm	L mm			
128	144	chrom chrome хром	aluminium aluminium алюминий	ZnAl
		UZ-AGIOS-128-01	UZ-AGIOS-128-05	

Uchwyt HILL  
Handle HILL  
Ручка HILL



NEW

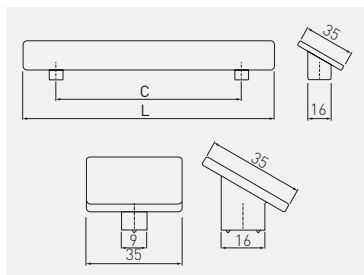
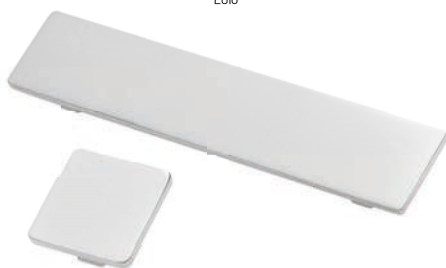

C mm	L mm					
128	173	chrom chrome хром	aluminium aluminium алюминий	stal szczotkowana brushed steel шлифованная сталь	czarny chrom black chrome чёрный хром	ZnAl
160	205	UZ-HILL-128-01	UZ-HILL-128-05	UZ-HILL-128-06	UZ-HILL-128-12	
		UZ-HILL-160-01	UZ-HILL-160-05	UZ-HILL-160-06	UZ-HILL-160-12	
gałka knob ручка	-	GZ-HILL-1-01	GZ-HILL-1-05	GZ-HILL-1-06	GZ-HILL-1-12	

Uchwyt MONZA  
Handle MONZA  
Ручка MONZA

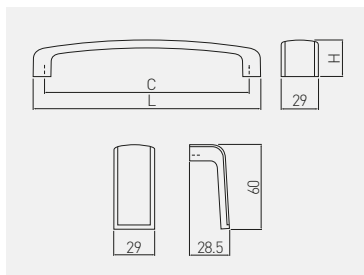

C mm	L mm	H mm			
16	29	28.5	stal szorstkowana / chrom brushed steel / chrome шлифованная сталь / хром	biały / chrom white / chrome белый / хром	czarny / chrom black / chrome чёрный / хром
160	178	29	UZ-MONZA160-06	UZ-MONZA160-10	UZ-MONZA160-20
256	274	33	UZ-MONZA256-06	UZ-MONZA256-10	UZ-MONZA256-20
384	402	34	UZ-MONZA384-06	UZ-MONZA384-10	UZ-MONZA384-20
ZnAl, aluminium ZnAl, aluminium ZnAl, алюминий					

Uchwyt ACRYL  
Handle ACRYL  
Ручка ACRYL

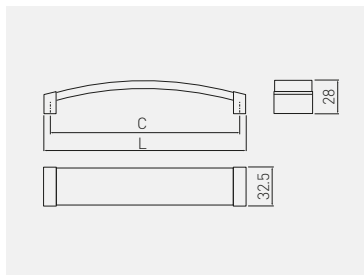

C mm	L mm			
160	170	chrom chrome хром	aluminium aluminium алюминий	ZnAl, акрил ZnAl, акрил ZnAl, акрил
		UZ-ACRYL-Z111160	*	

\* Produkt dostępny na indywidualne zamówienie / Available for special orders / Товар доступен под заказ.

Uchwyt OLIVA  
Handle OLIVA  
Ручка OLIVA

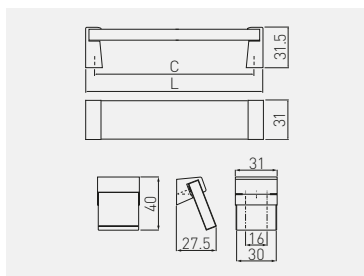

C mm	L mm		
		chrom chrome хром	ZnAl, akryl ZnAl, acrylic ZnAl, акрил
160	174	UZ-0160PR-01	
192	207	UZ-0192PR-01	
256	271	UZ-0256PR-01	
gatka knob ручка	-	GZ-OLIVA-16-01*	

\*Produkt dostępny na indywidualne zamówienie / Available for special orders / Товар доступен под заказ

Uchwyt ROSES  
Handle ROSES  
Ручка ROSES

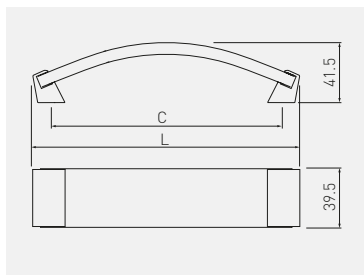





C mm	L mm		
		chrom / szkło przezroczyste chrome / transparent glass хром / прозрачное стекло	ZnAl, szkło ZnAl, glass ZnAl, стекло
160	185	UZ-R160PR-01	
256	280	UZ-R256PR-01	
		chrom / szkło białe chrome / white glass хром / белое стекло	ZnAl, szkło ZnAl, glass ZnAl, стекло
		czarny / szkło czarne black / black glass чёрный / черное стекло	
		UZ-R160BI-01	
		UZ-R256BI-01	
		UZ-ROS160-20	
		UZ-ROS256-20	

MODERN

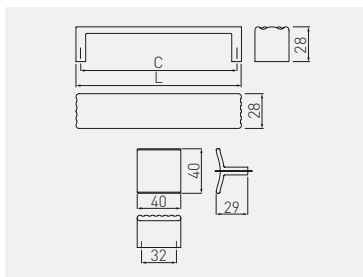

Uchwyt CADIS  
Handle CADIS  
Ручка CADIS





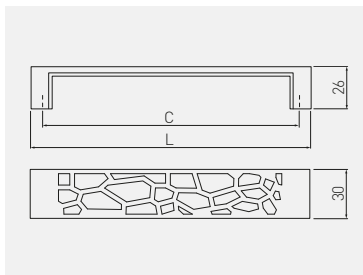

 C mm	 L mm		
		chrom chrome хром	aluminium aluminium алюминий
32	40	GZ-CAD032-01	-
128	136	UZ-CAD128-01	-
160	168	UZ-CAD160-01	UZ-CAD160-05*
320	328	UZ-CAD320-01	UZ-CAD320-05*

\* Produkt dostępny na indywidualne zamówienie./ Available for special orders./ Товар доступен под заказ.





Uchwyt VERA  
Handle VERA  
Ручка VERA

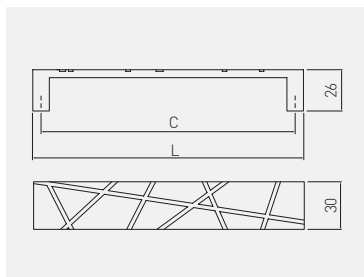
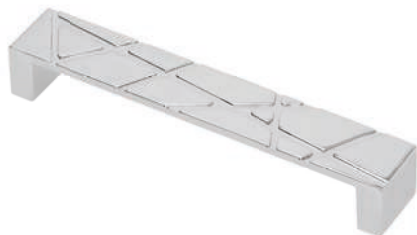

 C mm	 L mm		
		chrom chrome хром	kadm cadmium кадмий
160	174	UZ-VER160-01	UZ-VER160-08





Uchwyt ORIA  
Handle ORIA  
Ручка ORIA



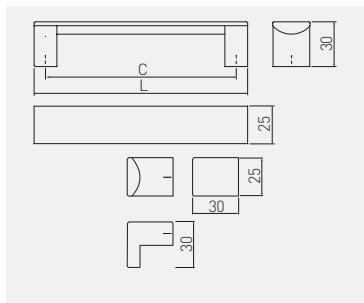



 C mm	 L mm		
		chrom chrome хром	kadm cadmium кадмий
160	172	UZ-ORI160-01	UZ-ORI160-08

Uchwyt ARES  
Handle ARES  
Ручка ARES





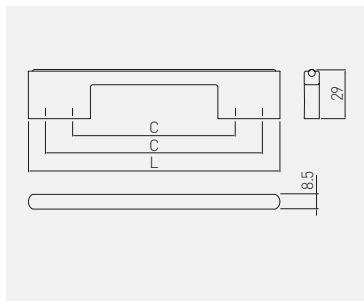

 C mm	 L mm		
		czarny black чёрный	aluminium aluminium алюминий
96	111	UA-ARS096-20	
128	143	UA-ARS128-20	
160	175	UA-ARS160-20	
192	207	UA-ARS192-20	
224	239	UA-ARS224-20	

 C mm	 L mm		
		czarny black чёрный	aluminium aluminium алюминий
256	271	UA-ARS256-20	
320	335	UA-ARS320-20	
gatka knob ручка		UA-ARSG30-20	





Uchwyt ASTI  
Handle ASTI  
Ручка ASTI

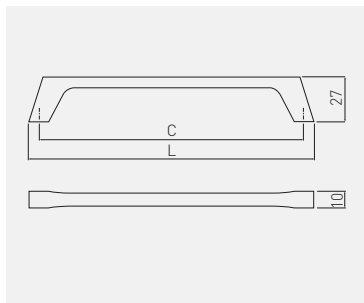

 C mm	 L mm		
		chrom chrome хром	ZnAl
96 / 128	148	UZ-ASTI096/128-01	
192 / 224	245	UZ-ASTI192/224-01	
288 / 320	340	UZ-ASTI288/320-01	

Uchwyt UZ-G2  
Handle UZ-G2  
Ручка UZ-G2



 C mm	 L mm		
		chrom chrome хром	stal szczotkowana brushed steel шлифованная сталь
160	172	UZ-G2-160-01	UZ-G2-160-06
224	236	UZ-G2-224-01	UZ-G2-224-06

Uchwyt BAGIO  
Handle BAGIO  
Ручка BAGIO

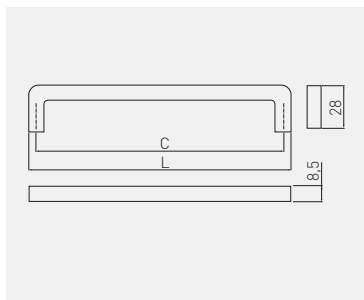

C mm	L mm					
		chrom chrome хром	aluminium aluminium алюминий	stal szcztokowana brushed steel шлифованная сталь	tytan szcztokowany brushed titanium шлифованный титан	ZnAl
160	168	UZ-BAGIO-160-01	UZ-BAGIO-160-05	UZ-BAGIO-160-06	UZ-BAGIO-160-11	

Uchwyt TIVOLI  
Handle TIVOLI  
Ручка TIVOLI

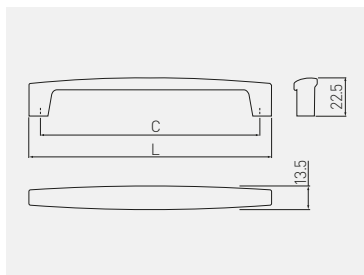

C mm	L mm					
		chrom chrome хром	czarny chrom black chrome чёрный хром	tytan titanium титан		ZnAl
192	206	UZ-TIVOL-192-01	UZ-TIVOL-192-12	UZ-TIVOL-192-13		
320	334	UZ-TIVOL-320-01	UZ-TIVOL-320-12	UZ-TIVOL-320-13		

Uchwyt PRATO  
Handle PRATO  
Ручка PRATO

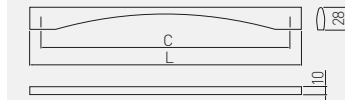

C mm	L mm				
		chrom chrome хром	aluminium aluminium алюминий	stal szcztkowana brushed steel шлифованная сталь	ZnAl
160	189	UZ-PRATO-160-01	UZ-PRATO-160-05	UZ-PRATO-160-06	
320	349	UZ-PRATO-320-01	UZ-PRATO-320-05	UZ-PRATO-320-06	

Uchwyt SOLANA  
Handle SOLANA  
Ручка SOLANA

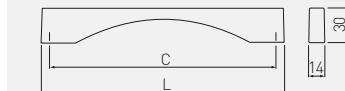

C mm	L mm				
		chrom chrome хром	tytan szcztkowany brushed titanium шлифованный титан	antyczny mosiądz szcztkowany antique brushed brass античная шлифованная латунь	ZnAl
192	208	UZ-SOLANA192-01	UZ-SOLANA192-11	UZ-SOLANA192-09	
320	336	UZ-SOLANA320-01	UZ-SOLANA320-11	UZ-SOLANA320-09	

Uchwyt PADWA  
Handle PADWA  
Ручка PADWA

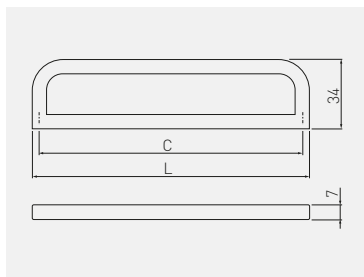

C mm	L mm			
		chrom chrome хром	stal szorstkowana brushed steel шлифованная сталь	
128	135	UZ-PADWA128-01	UZ-PADWA128-06	ZnAl
160	167	UZ-PADWA160-01	UZ-PADWA160-06	
192	199	UZ-PADWA192-01	UZ-PADWA192-06	
224	231	UZ-PADWA224-01	UZ-PADWA224-06	

Uchwyt KATANIA  
Handle KATANIA  
Ручка KATANIA

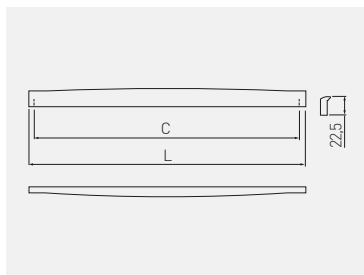

C mm	L mm			
		chrom chrome хром	czarny chrom black chrome чёрный хром	
320	334	UZ-KATAN-320-01	UZ-KATAN-320-12	ZnAl

Gatka IMOLA  
Knob IMOLA  
Ручка IMOLA

NEW

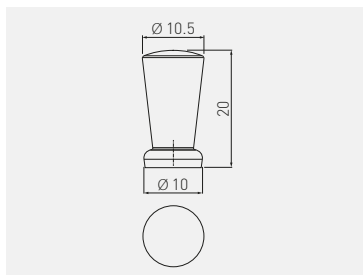

	chrom chrome хром	satyna satin сатин	aluminium aluminium алюминий	stal szcztokowana brushed steel шлифованная сталь	ZnAl
gatka knob ручка	GZ-IMOLA-1-01	GZ-IMOLA-1-02	GZ-IMOLA-1-05	GZ-IMOLA-1-06	

Gatka ROMA  
Knob ROMA  
Ручка ROMA

NEW

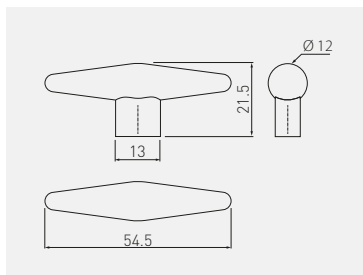

	chrom chrome хром	satyna satin сатин	aluminium aluminium алюминий	stal szcztokowana brushed steel шлифованная сталь	ZnAl
gatka knob ручка	GZ-ROMA-1-01	GZ-ROMA-1-02	GZ-ROMA-1-05	GZ-ROMA-1-06	



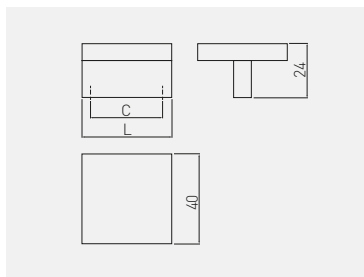

Uchwyt UZ-40  
Handle UZ-40  
Ручка UZ-40

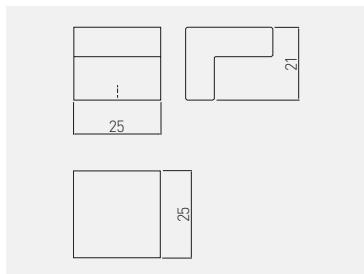

 C mm	 L mm					
32	40	chrom chrome хром	satyna satin сатин	aluminium aluminium алюминий	stal szczotkowana brushed steel шлифованная сталь	ZnAl
		UZ-40-032-01	UZ-40-032-02	UZ-40-032-05	UZ-40-032-06	

Uchwyt UZ-55  
Handle UZ-55  
Ручка UZ-55







 C mm	 L mm			
		chrom chrome хром	aluminium aluminium алюминий	ZnAl
gatka knob ручка	25	UZ-55-025-01	UZ-55-025-05	

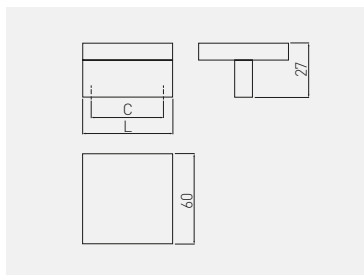
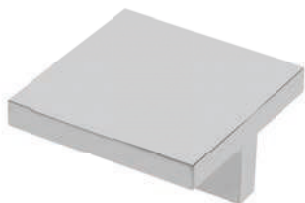





Uchwyt UZ-60  
Handle UZ-60  
Ручка UZ-60

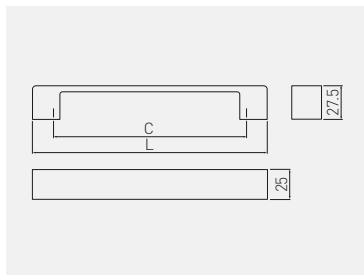

 C mm	 L mm					
		chrom chrome хром	satyna satin сатин	aluminium aluminium алюминий	stal szczotkowana brushed steel шлифованная сталь	ZnAl
32	60	UZ-60-032-01	UZ-60-032-02	UZ-60-032-05	UZ-60-032-06	

Uchwyt UZ-79F  
Handle UZ-79F  
Ручка UZ-79F



 C mm	 L mm				
		chrom chrome хром	stal szczotkowana brushed steel шлифованная сталь		ZnAl
160	195	UZ-79F160-01	UZ-79F160-06		
192	227	UZ-79F192-01	UZ-79F192-06		

Uchwyt UZ-133  
Handle UZ-133  
Ручка UZ-133

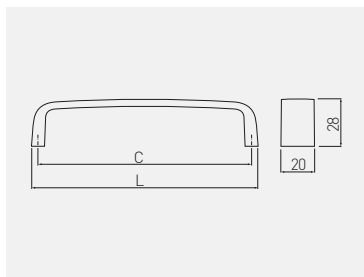

C mm	L mm					
		chrom chrome хром	satyna satin сатин	aluminium aluminium алюминий	stal szczotkowana brushed steel шлифованная сталь	ZnAl
128	135	UZ-133128-01	UZ-133128-02	UZ-133128-05	UZ-133128-06	



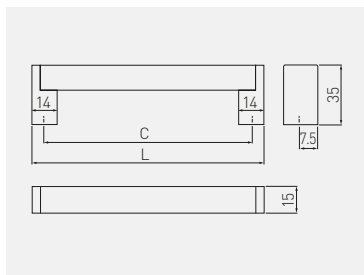

Uchwyt UZ-334  
Handle UZ-334  
Ручка UZ-334

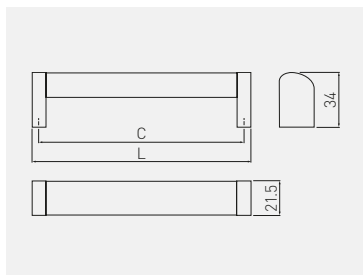

C mm	L mm		
		stal szczotkowana brushed steel шлифованная сталь	
128	144	UZ-334128-06	ZnAl, stal ZnAl, steel ZnAl, сталь
160	175	UZ-334160-06	
192	206	UZ-334192-06	
256	272	UZ-334256-06	
320	335	UZ-334320-06	





Uchwyt UZ-335  
Handle UZ-335  
Ручка UZ-335

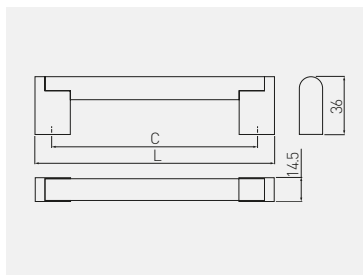

 C mm	 L mm		
		stal szczotkowana brushed steel шлифованная сталь	ZnAl, stal ZnAl, steel ZnAl, сталь
128	137	UZ-335128-06	
160	169	UZ-335160-06	
192	212	UZ-335192-06	
256	265	UZ-335256-06	



Uchwyt UZ-336  
Handle UZ-336  
Ручка UZ-336



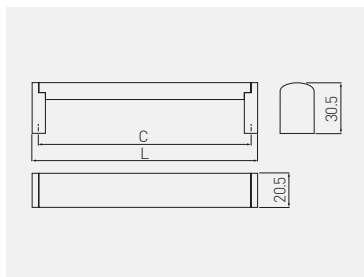

 C mm	 L mm		
		stal szczotkowana brushed steel шлифованная сталь	ZnAl, stal ZnAl, steel ZnAl, сталь
128	148	UZ-336128-06	
160	182	UZ-336160-06	
192	213	UZ-336192-06	
256	276	UZ-336256-06	
320	340	UZ-336320-06	
416	436	UZ-336416-06	
480	500	UZ-336480-06	

Uchwyt UZ-682  
Handle UZ-682  
Ручка UZ-682





C mm	L mm		
		stal szcztokowana brushed steel шлифованная сталь	stal, ZnAl steel, ZnAl сталь, ZnAl
128	136	UZ-682128-06	
160	170	UZ-682160-06	
192	209	UZ-682192-06	
224	232	UZ-682224-06	

C mm	L mm		
		stal szcztokowana brushed steel шлифованная сталь	stal, ZnAl steel, ZnAl сталь, ZnAl
256	266	UZ-682256-06	
320	329	UZ-682320-06	
416	425	UZ-682416-06	
480	489	UZ-682480-06	

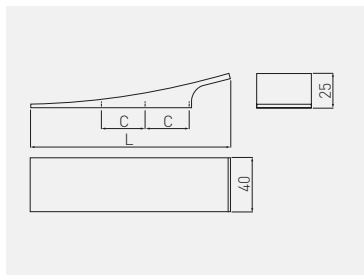
Uchwyt UZ-804  
Handle UZ-804  
Ручка UZ-804



C mm	L mm		
		chrom chrome хром	ZnAl
32*	145	UZ-804064-01	

\*Mocowanie na 3 wkręty / Mounted with 3 screws / Крепление на 3 самореза.

Uchwyt UZ-819  
Handle UZ-819  
Ручка UZ-819

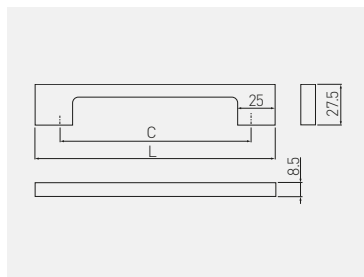

 C mm	 L mm					
C	L	chrom chrome хром	satyna satin сатин	aluminium aluminium алюминий	stal szcztokowana brushed steel шлифованная сталь	ZnAl
96	129	UZ-819096-01	UZ-819096-02	UZ-819096-05	UZ-819096-06	
128	161	UZ-819128-01	UZ-819128-02	UZ-819128-05	UZ-819128-06	
160	193	UZ-819160-01	UZ-819160-02	UZ-819160-05	UZ-819160-06	
192	225	UZ-819192-01	UZ-819192-02	UZ-819192-05	UZ-819192-06	
256	289	UZ-819256-01	UZ-819256-02	UZ-819256-05	UZ-819256-06	
320	353	UZ-819320-01	UZ-819320-02	UZ-819320-05	UZ-819320-06	





 C mm	 L mm					
C	L	biały white белый	czarny black чёрный	czarny chrom black chrome чёрный хром	antyczna miedź antique copper античная медь	ZnAl
96	129	UZ-819096-10	UZ-819096-20	UZ-819096-12	UZ-819096-14	
128	161	UZ-819128-10	UZ-819128-20	UZ-819128-12	UZ-819128-14	
160	193	UZ-819160-10	UZ-819160-20	UZ-819160-12	UZ-819160-14	
192	225	UZ-819192-10	UZ-819192-20	UZ-819192-12	UZ-819192-14	
256	289	UZ-819256-10	UZ-819256-20	UZ-819256-12	UZ-819256-14	
320	353	UZ-819320-10	UZ-819320-20	UZ-819320-12	UZ-819320-14	

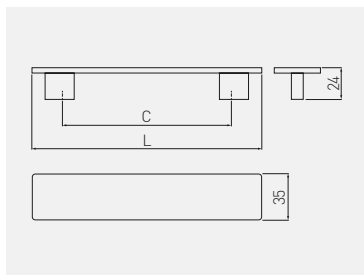
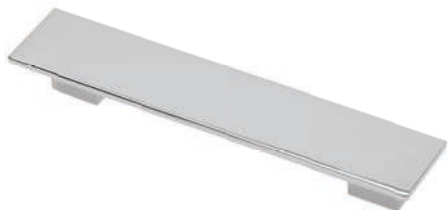

antyczna miedź  
antique copper  
античная медь



Uchwyt UZ-870  
Handle UZ-870  
Ручка UZ-870



 C mm	 L mm		
		chrom chrome хром	ZnAl
128	174	UZ-870128-01	

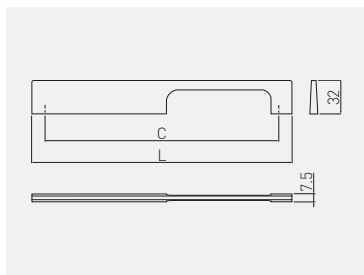



Uchwyt UZ-872  
Handle UZ-872  
Ручка UZ-872

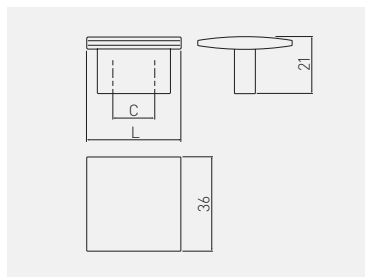

 C mm	 L mm			
		chrom chrome хром	aluminium aluminium алюминий	
224	249	UZ-872224-01	stal szcztkowana brushed steel шлифованная сталь	
			UZ-872224-06	
				ZnAl

Uchwyt UZ-880  
Handle UZ-880  
Ручка UZ-880



 C mm	 L mm		
16	36	chrom chrome хром	ZnAl
		UZ-880016-01	

Uchwyt UZ-883  
Handle UZ-883  
Ручка UZ-883

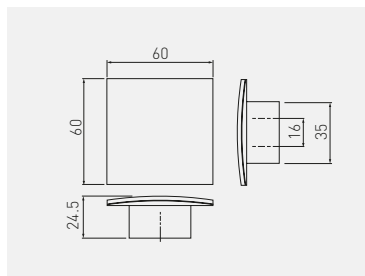

 C mm	 L mm					
16	60	chrom chrome хром	satyna satin сатин	aluminium aluminium алюминий	stal szcztokowana brushed steel шлифованная сталь	ZnAl
		UZ-883016-01	UZ-883016-02	UZ-883016-05	UZ-883016-06	

Uchwyt US-SKA  
Handle US-SKA  
Ручка US-SKA

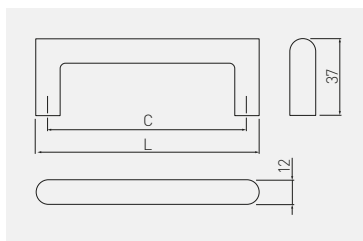

C mm	L mm		
		stal szczotkowana brushed steel шлифованная сталь	stal steel сталь
128	140	US-SKA128-06	
160	172	US-SKA160-06	
192	204	US-SKA192-06	

Na indywidualne zamówienie dostępne również rozstawy: 96, 224, 320, 352, 560 (mm)

Other sizes are available for special orders: 96, 224, 320, 352, 560 (mm).

Под заказ доступны ручки с межцентровым расстоянием: 96, 224, 320, 352, 560 (мм)

Uchwyt US-SK0  
Handle US-SK0  
Ручка US-SK0

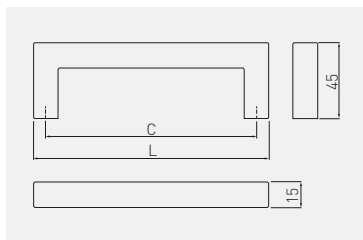

C mm	L mm			C mm	L mm		
		stal szczotkowana brushed steel шлифованная сталь	stal steel сталь			stal szczotkowana brushed steel шлифованная сталь	stal steel сталь
128	143	US-SK0128-06		384	399	US-SK0384-06	
160	175	US-SK0160-06		448	463	US-SK0448-06	
192	207	US-SK0192-06		480	495	US-SK0480-06	
224	239	US-SK0224-06		576	591	US-SK0576-06	
256	271	US-SK0256-06		672	687	US-SK0672-06	
320	335	US-SK0320-06		800	815	US-SK0800-06	



Uchwyt UA-A3  
Handle UA-A3  
Ручка UA-A3

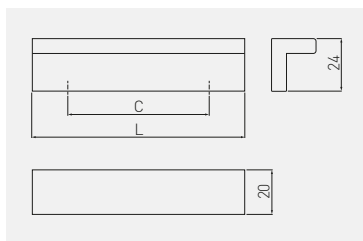

C mm	L mm			
		aluminium aluminium алюминий		aluminium aluminium алюминий
96	128	UA-A3-096128		
128	160	UA-A3-128160		
160	192	UA-A3-160192		
192	224	UA-A3-192224		
256	288	UA-A3-256288		
320	352	UA-A3-320352		

Uchwyt UA-A4  
Handle UA-A4  
Ручка UA-A4

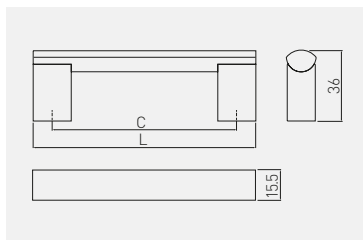

C mm	L mm			
		aluminium aluminium алюминий	stal szczotkowana brushed steel шлифованная сталь	aluminium aluminium алюминий
128	148	UA-AA-04-128	UA-A4-128-06MJ	
160	180	UA-AA-04-160	UA-A4-160-06MJ	
192	212	UA-AA-04-192	*	
224	244	UA-AA-04-224	*	
256	276	UA-AA-04-256	UA-A4-256-06MJ	
288	308	UA-AA-04-288	*	
320	340	UA-AA-04-320	UA-A4-320-06MJ	

Uchwyt UA-B311  
Handle UA-B311  
Ручка UA-B311

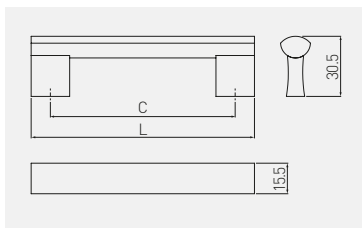

C  
mm  
L  
mm



C	L	chrom chrome хром	aluminium aluminium алюминий	stal szcztokowana brushed steel шлифованная сталь	
96	116	*	UA-B0-311096	UA-B31109606MJ	aluminium aluminium алюминий
128	148	UA-B31112801	UA-B0-311128	UA-B31112806MJ	
160	180	UA-B31116001	UA-B0-311160	UA-B31116006MJ	
192	212	UA-B31119201	UA-B0-311192	UA-B31119206MJ	
224	244	UA-B31122401	UA-B0-311224	UA-B31122406MJ	
256	276	UA-B31125601	UA-B0-311256	UA-B31125606MJ	
288	307	*	UA-B0-311288	*	
320	340	UA-B31132001	UA-B0-311320	UA-B31132006MJ	
480	500	*	UA-B0-311480	*	

\*Produkt dostępny na indywidualne zamówienie / Available for special orders / Товар доступен под заказ

Uchwyt UA-B337  
Handle UA-B337  
Ручка UA-B337

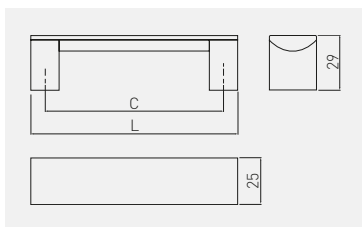

C  
mm  
L  
mm



C	L	chrom chrome хром	aluminium aluminium алюминий	stal szcztokowana brushed steel шлифованная сталь	
128	143	UA-B33712801	UA-B0-337128	UA-B33712806MJ	aluminium aluminium алюминий
160	175	UA-B33716001	UA-B0-337160	UA-B33716006MJ	
192	207	UA-B33719201	UA-B0-337192	UA-B33719206MJ	
224	239	UA-B33722401	UA-B0-337224	UA-B33722406MJ	
256	271	UA-B33725601	UA-B0-337256	UA-B33725606MJ	
320	335	UA-B33732001	UA-B0-337320	UA-B33732006MJ	
416	431	*	UA-B0-337416	UA-B33741606MJ	
480	495	UA-B33748001	UA-B0-337480	UA-B33748006MJ	

\*Produkt dostępny na indywidualne zamówienie / Available for special orders / Товар доступен под заказ

Uchwyt UA-114  
Handle UA-114  
Ручка UA-114

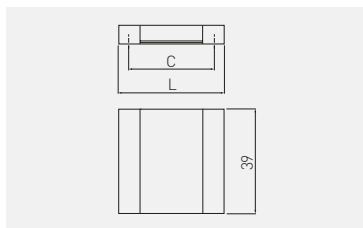

C mm	L mm			
32	39	satyna satin сатин	aluminium aluminium алюминий	aluminium aluminium алюминий



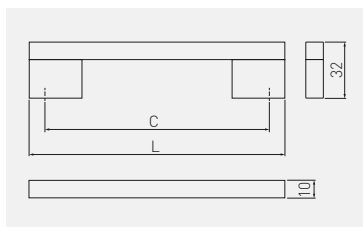

Uchwyt UA-18  
Handle UA-18  
Ручка UA-18

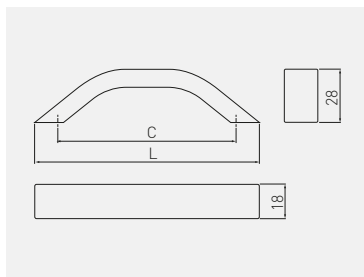

C mm	L mm				
128	146	chrom chrome хром	aluminium aluminium алюминий	stal szorstkowana brushed steel шлифованная сталь	aluminium aluminium алюминий
160	178	UA-A18128-01	UA-18-128146	UA-A18128-06MJ	
192	210	UA-A18160-01	UA-18-160178	UA-A18160-06MJ	
224	242	UA-A18192-01	UA-18-192210	UA-A18192-06MJ	
256	274	UA-A18224-01	UA-18-224242	UA-A18224-06MJ	
320	338	UA-A18256-01	UA-18-256274	UA-A18256-06MJ	
400	418	UA-A18320-01	UA-18-320338	UA-A18320-06MJ	
416	434	UA-A18400-01	UA-18-400418	UA-A18400-06MJ	
480	498	UA-A18416-01	UA-18-416434	UA-A18416-06MJ	
		UA-A18480-01	UA-18-480498	UA-A18480-06MJ	





Uchwyt UA-313  
Handle UA-313  
Ручка UA-313

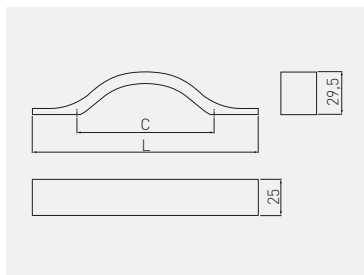

 C mm	 L mm		
		aluminium aluminium алюминий	aluminium aluminium алюминий
128	150	UA-00-313128	
160	182	UA-00-313160	
192	214	UA-00-313192	





Uchwyt UA-319  
Handle UA-319  
Ручка UA-319

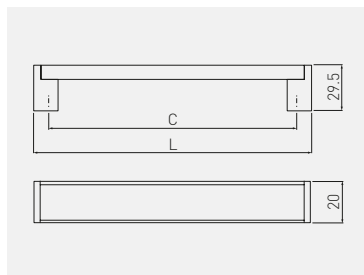

 C mm	 L mm		
		aluminium aluminium алюминий	aluminium aluminium алюминий
96	158	UA-00-319096	
128	189	UA-00-319128	
160	231	UA-00-319160	

Uchwyt LUNA  
Handle LUNA  
Ручка LUNA





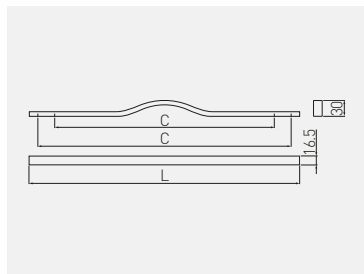

 C mm	 L mm			
		satyna / chrom satin / chrome сатин / хром	aluminium / chrom aluminium / chrome алюминий / хром	aluminium aluminium алюминий
160	179	UA-LUNA20160-SN	UA-LUNA20160-AL	
192	211	UA-LUNA20192-SN	UA-LUNA20192-AL	
256	275	UA-LUNA20256-SN	UA-LUNA20256-AL	
320	339	UA-LUNA20320-SN	UA-LUNA20320-AL	

MODERN

Uchwyt DOPPIO  
Handle DOPPIO  
Ручка DOPPIO



 C mm	 L mm			
	L	chrom / aluminium chrome / aluminium хром / алюминий		aluminium aluminium алюминий
192 / 224	256	UA-DOPPIO192-01		
416 / 480	512	UA-DOPPIO416-01		

Uchwyt THIN  
Handle THIN  
Ручка THIN

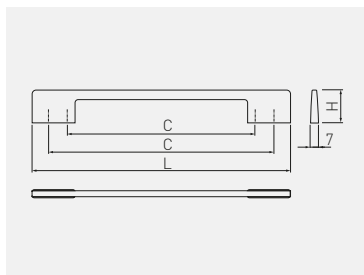

C mm	L mm	H mm					
			chrom chrome хром	satyna satin сатин	aluminium aluminium алюминий	stal szczerotkowana brushed steel шлифованная сталь	ZnAl
96/128	156	24	UZ-TH096128-01	UZ-TH096128-02	UZ-TH096128-05	UZ-TH096128-06	
160/192	220	28	UZ-TH160192-01	UZ-TH160192-02	UZ-TH160192-05	UZ-TH160192-06	
288/320	348	28	UZ-TH288320-01	UZ-TH288320-02	UZ-TH288320-05	UZ-TH288320-06	

Uchwyt PICCOLO\*  
Handle PICCOLO\*  
Ручка PICCOLO\*

NEW

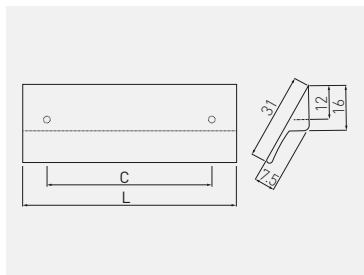
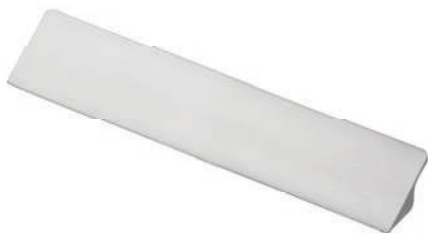

C mm	L mm		
		aluminium aluminium алюминий	aluminium aluminium алюминий
64	80	UA-PICCO-64-05	
128	145	UA-PICCO-128-05	
224	240	UA-PICCO-224-05	

\*Produkt dostępny na indywidualne zamówienie / Available for special orders / Товар доступен под заказ

Uchwyt ALFA\*  
Handle ALFA\*  
Ручка ALFA\*

NEW

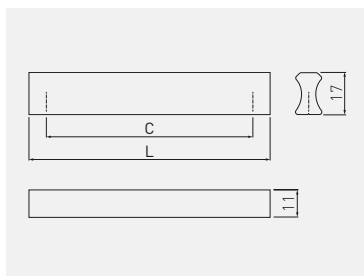

C mm	L mm		
		aluminium aluminium алюминий	aluminium aluminium алюминий
32	46	UA-ALFA-32-05	
96	110	UA-ALFA-96-05	
128	142	UA-ALFA-128-05	
160	174	UA-ALFA-160-05	
192	206	UA-ALFA-192-05	

C mm	L mm		
		aluminium aluminium алюминий	aluminium aluminium алюминий
224	238	UA-ALFA-224-05	
256	270	UA-ALFA-256-05	
288	302	UA-ALFA-288-05	
320	334	UA-ALFA-320-05	

\*Produkt dostępny na indywidualne zamówienie / Available for special orders / Товар доступен под заказ

Uchwyt BETA\*  
Handle BETA\*  
Ручка BETA\*

NEW

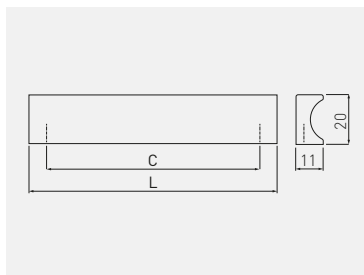

C mm	L mm		
		aluminium aluminium алюминий	aluminium aluminium алюминий
96	110	UA-BETA-96-05	
128	142	UA-BETA-128-05	
160	174	UA-BETA-160-05	
192	206	UA-BETA-192-05	

C mm	L mm		
		aluminium aluminium алюминий	aluminium aluminium алюминий
224	238	UA-BETA-224-05	
256	270	UA-BETA-256-05	
288	302	UA-BETA-288-05	
320	334	UA-BETA-320-05	

\*Produkt dostępny na indywidualne zamówienie / Available for special orders / Товар доступен под заказ

Uchwyt GAMMA\*  
Handle GAMMA\*  
Ручка GAMMA\*

NEW

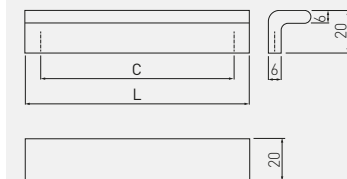

C mm	L mm		
		aluminium aluminium алюминий	aluminium aluminium алюминий
96	110	UA-GAMMA-96-05	
128	142	UA-GAMMA-128-05	
160	174	UA-GAMMA-160-05	
192	206	UA-GAMMA-192-05	

C mm	L mm		
		aluminium aluminium алюминий	aluminium aluminium алюминий
224	238	UA-GAMMA-224-05	
256	270	UA-GAMMA-256-05	
288	302	UA-GAMMA-288-05	
320	334	UA-GAMMA-320-05	

\*Produkt dostępny na indywidualne zamówienie / Available for special orders / Товар доступен под заказ

Uchwyt DELTA\*  
Handle DELTA\*  
Ручка DELTA\*

NEW

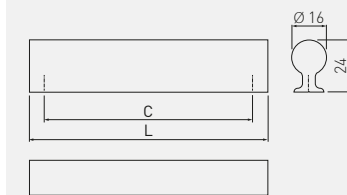

C mm	L mm		
		aluminium aluminium алюминий	aluminium aluminium алюминий
96	110	UA-DELTA-96-05	
128	142	UA-DELTA-128-05	
160	174	UA-DELTA-160-05	
192	206	UA-DELTA-192-05	

C mm	L mm		
		aluminium aluminium алюминий	aluminium aluminium алюминий
224	238	UA-DELTA-224-05	
256	270	UA-DELTA-256-05	
288	302	UA-DELTA-288-05	
320	334	UA-DELTA-320-05	

\*Produkt dostępny na indywidualne zamówienie / Available for special orders / Товар доступен под заказ



Uchwyt SIGMA\*  
Handle SIGMA\*  
Ручка SIGMA\*

NEW

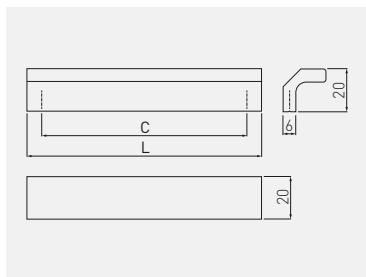

C mm	L mm		
		aluminium aluminium алюминий	aluminium aluminium алюминий
96	110	UA-SIGMA-96-05	
128	142	UA-SIGMA-128-05	
160	174	UA-SIGMA-160-05	
192	206	UA-SIGMA-192-05	
224	238	UA-SIGMA-224-05	
256	270	UA-SIGMA-256-05	
288	302	UA-SIGMA-288-05	
320	334	UA-SIGMA-320-05	

\*Produkt dostępny na indywidualne zamówienie / Available for special orders / Товар доступен под заказ

MODERN

Uchwyt KAPPA\*  
Handle KAPPA\*  
Ручка KAPPA\*

NEW

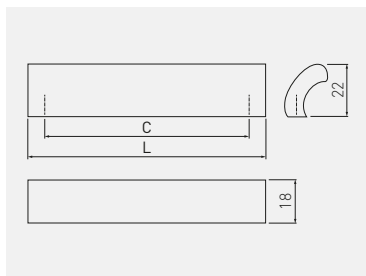



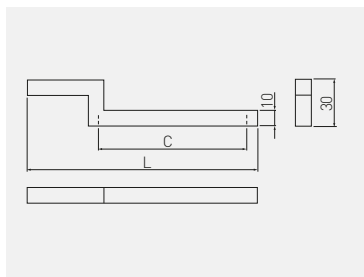
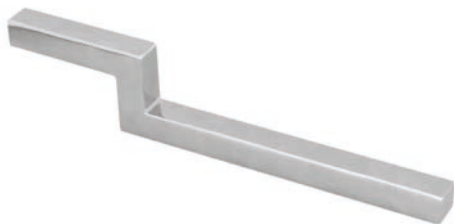

C mm	L mm		
		aluminium aluminium алюминий	aluminium aluminium алюминий
96	110	UA-KAPPA-96-05	
128	142	UA-KAPPA-128-05	
160	174	UA-KAPPA-160-05	
192	206	UA-KAPPA-192-05	
224	238	UA-KAPPA-224-05	
256	270	UA-KAPPA-256-05	
288	302	UA-KAPPA-288-05	
320	334	UA-KAPPA-320-05	

\*Produkt dostępny na indywidualne zamówienie / Available for special orders / Товар доступен под заказ

Uchwyt ALRA\*  
Handle ALRA\*  
Ручка ALRA\*



 C mm	 L mm			
		chrom chrome хром	stal szczotkowana brushed steel шлифованная сталь	ZnAl
96	149	UZ-ALRA096-01	UZ-ALRA096-06	

\*Produkt dostępny na indywidualne zamówienie / Available for special orders / Товар доступен под заказ

Uchwyt UZ-92\*  
Handle UZ-92\*  
Ручка UZ-92\*

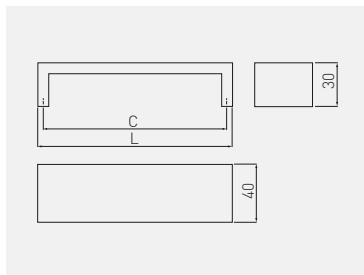



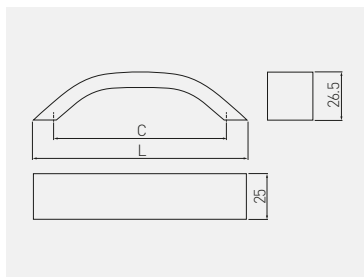

 C mm	 L mm				
		chrom chrome хром	satyna satin сатин	aluminium aluminium алюминий	ZnAl
128	135	UZ-92-128-01	-	UZ-92-128-05	
160	167	-	UZ-92-160-02	-	

\*Produkt dostępny na indywidualne zamówienie / Available for special orders / Товар доступен под заказ





Uchwyt UA-337  
Handle UA-337  
Ручка UA-337

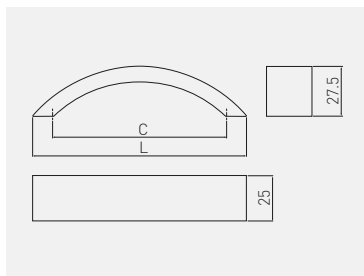

 C mm	 L mm		
		aluminium aluminium алюминий	
96	116	UA-00-337096	aluminium aluminium алюминий
128	146	UA-00-337128	
160	180	UA-00-337160	
192	212	UA-00-337192	
224	244	UA-00-337224	
256	275	UA-00-337256	
320	340	UA-00-337320	

Uchwyt UA-338  
Handle UA-338  
Ручка UA-338



 C mm	 L mm		
		aluminium aluminium алюминий	aluminium aluminium алюминий
128	137	UA-00-338128	
160	169	UA-00-338160	

Uchwyt UA-340  
Handle UA-340  
Ручка UA-340

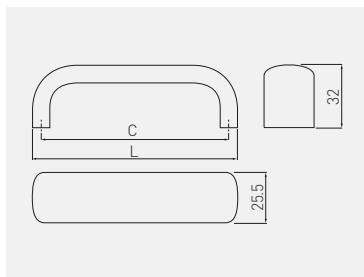

C mm	L mm			
			aluminium aluminium алюминий	
128	137		UA-00-340128	aluminium aluminium алюминий
160	169		UA-00-340160	
192	201		UA-00-340192	
224	233		UA-00-340224	
256	265		UA-00-340256	
320	329		UA-00-340320	



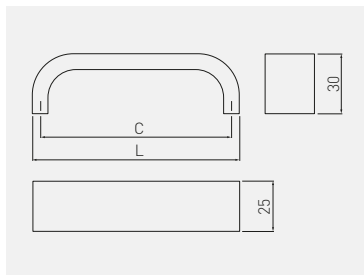

Uchwyt UA-347  
Handle UA-347  
Ручка UA-347

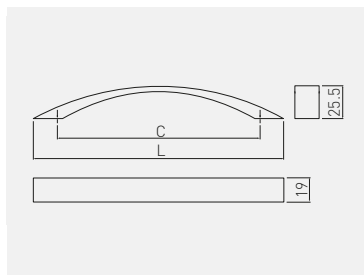

C mm	L mm			
			aluminium aluminium алюминий	
128	136		UA-00-347128	aluminium aluminium алюминий
160	168		UA-00-347160	
192	200		UA-00-347192	
224	232		UA-00-347224	
256	264		UA-00-347256	
320	328		UA-00-347320	





Uchwyt CALABRIA  
Handle CALABRIA  
Ручка CALABRIA

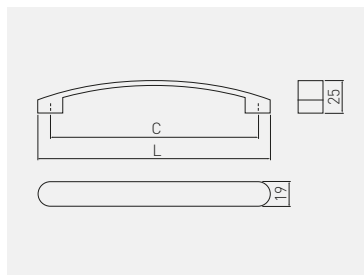

 C mm	 L mm			
		chrom chrome хром	stal szczotkowana brushed steel шлифованная сталь	ZnAl
160	195	UZ-CALABRIA160-01	UZ-CALABRIA160-06	
192	224	UZ-CALABRIA192-01	UZ-CALABRIA192-06	
224	258	UZ-CALABRIA224-01	UZ-CALABRIA224-06	

Uchwyt GENUA  
Handle GENUA  
Ручка GENUA



 C mm	 L mm				
		chrom chrome хром	satyna satin сатин	aluminium aluminium алюминий	ZnAl
128	148	UZ-GENUA128-01	UZ-GENUA128-02	UZ-GENUA128-05	
160	180	UZ-GENUA160-01	UZ-GENUA160-02	UZ-GENUA160-05	

Uchwyt UZ-G1  
Handle UZ-G1  
Ручка UZ-G1

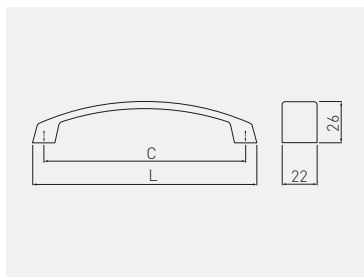

C mm	L mm	chrom chrome хром	aluminium aluminium алюминий	stal szczotkowana brushed steel шлифованная сталь	tytan titanium титан	ZnAl
128	142	UZ-G1-128-01	UZ-G1-128-05	UZ-G1-128-06	UZ-G1-128-13	
160	174	UZ-G1-160-01	UZ-G1-160-05	UZ-G1-160-06	UZ-G1-160-13	
192	206	UZ-G1-192-01	UZ-G1-192-05	UZ-G1-192-06	UZ-G1-192-13	
256	270	UZ-G1-256-01	UZ-G1-256-05	UZ-G1-256-06	UZ-G1-256-13	
320	334	UZ-G1-320-01	UZ-G1-320-05	UZ-G1-320-06	UZ-G1-320-13	
416	430	UZ-G1-416-01	UZ-G1-416-05	UZ-G1-416-06	-	

Uchwyt UZ-01  
Handle UZ-01  
Ручка UZ-01

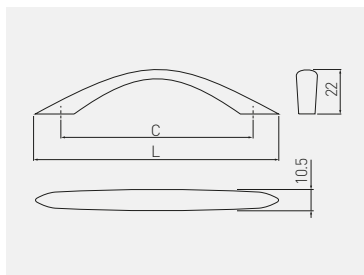

C mm	L mm	chrom chrome хром	satyna satin сатин	mosiądz brass латунь	aluminium aluminium алюминий	ZnAl
96	121	UZ-01-096-01	UZ-01-096-02	UZ-01-096-03	UZ-01-096-05	
128	158	UZ-01-128-01	UZ-01-128-02	UZ-01-128-03	UZ-01-128-05	

Uchwyt UZ-04  
Handle UZ-04  
Ручка UZ-04

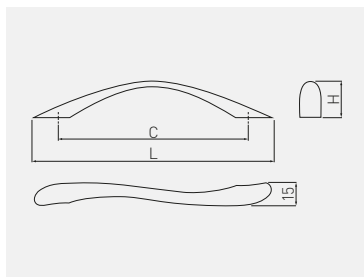

C mm	L mm	H mm	chrom chrome хром	satyna satin сатин	mosiądz brass латунь	aluminium aluminium алюминий	ZnAl
96	127	23	UZ-04-096-01	UZ-04-096-02	UZ-04-096-03	UZ-04-096-05	
128	158	24	UZ-04-128-01	UZ-04-128-02	UZ-04-128-03	UZ-04-128-05	

Uchwyt UZ-05  
Handle UZ-05  
Ручка UZ-05

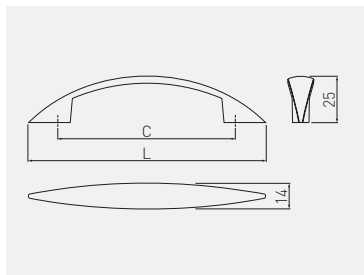

C mm	L mm	chrom chrome хром	satyna satin сатин	mosiądz brass латунь	aluminium aluminium алюминий	ZnAl
96	132	UZ-05-096-01	UZ-05-096-02	UZ-05-096-03	UZ-05-096-05	
128	164	UZ-05-128-01	UZ-05-128-02	UZ-05-128-03	UZ-05-128-05	

Uchwyt UZ-06  
Handle UZ-06  
Ручка UZ-06

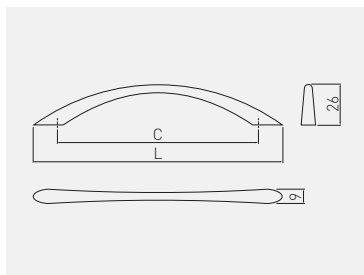

C mm	L mm					
		chrom chrome хром	satyna satin сатин	mosiądz brass латунь	aluminium aluminium алюминий	ZnAl
128	164	UZ-06-128-01	UZ-06-128-02	UZ-06-128-03	UZ-06-128-05	

Uchwyt UZ-07  
Handle UZ-07  
Ручка UZ-07

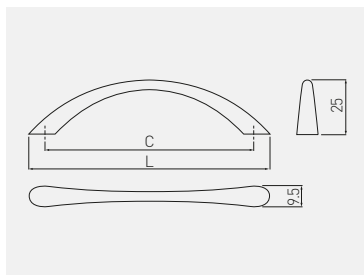

C mm	L mm					
		chrom chrome хром	satyna satin сатин	mosiądz brass латунь	aluminium aluminium алюминий	ZnAl
96	111	UZ-07-096-01	UZ-07-096-02	UZ-07-096-03	UZ-07-096-05	



Uchwyt UZ-Z10  
Handle UZ-Z10  
Ручка UZ-Z10

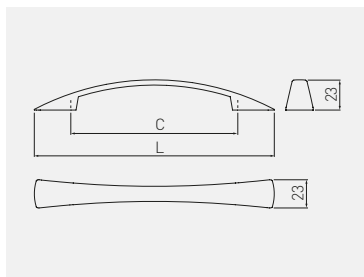

C mm	L mm					
		chrom chrome хром	satyna satin сатин	mosiądz brass латунь	aluminium aluminium алюминий	ZnAl
96	138	UZ-Z10096-01	UZ-Z10096-02	UZ-Z10096-03	UZ-Z10096-05	
128	184	UZ-Z10128-01	UZ-Z10128-02	UZ-Z10128-03	UZ-Z10128-05	

Uchwyt UZ-13  
Handle UZ-13  
Ручка UZ-13

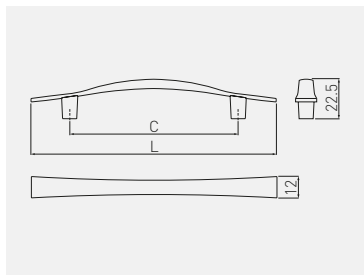

C mm	L mm					
		chrom chrome хром	satyna satin сатин	mosiądz brass латунь	aluminium aluminium алюминий	ZnAl
96	140	UZ-13-096-01	UZ-13-096-02	UZ-13-096-03	UZ-13-096-05	

Uchwyt UZ-14  
Handle UZ-14  
Ручка UZ-14

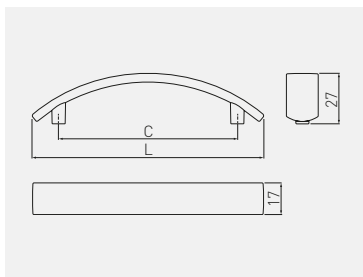

C mm	L mm					
		chrom chrome хром	satyna satin сатин	mosiądz brass латунь	aluminium aluminium алюминий	ZnAl
96	138	UZ-14-096-01	UZ-14-096-02	UZ-14-096-03	UZ-14-096-05	
128	184	UZ-14-128-01	UZ-14-128-02	UZ-14-128-03	UZ-14-128-05	

Uchwyt CAMAIO  
Handle CAMAIO  
Ручка CAMAIO

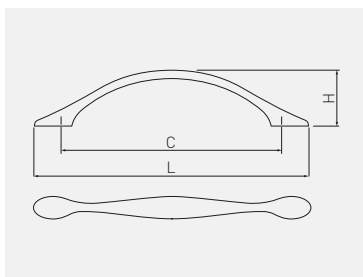

C mm	L mm	H mm				
			chrom chrome хром	satyna satin сатин	stal szorstkowana brushed steel шлифованная сталь	antyczny mosiądz szorstkowany antique brushed brass античная шлифованная латунь
96	126	23	UZ-CAMAI-96-01	UZ-CAMAI-96-02	UZ-CAMAI-96-06	UZ-CAMAI-96-09
128	160	32,5	UZ-CAMAI-128-01	UZ-CAMAI-128-02	UZ-CAMAI-128-06	UZ-CAMAI-128-09

C mm	L mm	H mm				
			biały mat white matt белый матовый	czarny mat black matt чёрный матовый	czarny chrom black chrome чёрный хром	ZnAl
96	126	23	UZ-CAMAI-96-10M	UZ-CAMAI-96-20M	UZ-CAMAI-96-12	
128	160	32,5	UZ-CAMAI-128-10M	UZ-CAMAI-128-20M	UZ-CAMAI-128-12	

Gatka BERGAMO  
Knob BERGAMO  
Ручка BERGAMO

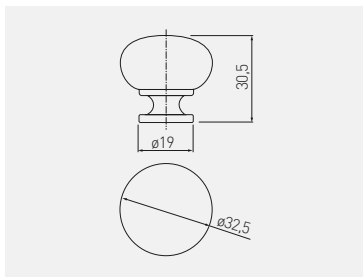





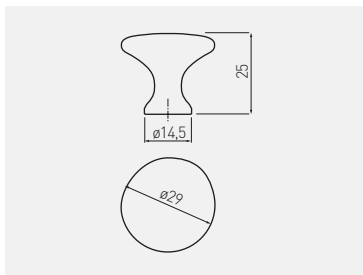

					
	chrom chrome хром	satyna satin сатин	aluminium aluminium алюминий	stal szorstkowana brushed steel шлифованная сталь	stal steel сталь
gatka knob ручка	GS-BERGA-1-01	GS-BERGA-1-02	GS-BERGA-1-05	GS-BERGA-1-06	

				
	biały white белый	czarny mat black matt чёрный матовый	czarny chrom black chrome чёрный хром	stal steel сталь
gatka knob ручка	GS-BERGA-1-10	GS-BERGA-1-20M	GS-BERGA-1-12	

Gatka UDINE  
Knob UDINE  
Ручка UDINE



					
	chrom chrome хром	satyna satin сатин	aluminium aluminium алюминий	stal szorstkowana brushed steel шлифованная сталь	ZnAl
gatka knob ручка	GZ-UDINE-1-01	GZ-UDINE-1-02	GZ-UDINE-1-05	GZ-UDINE-1-06	

				
	biały mat white matt белый матовый	czarny mat black matt чёрный матовый	czarny chrom black chrome чёрный хром	ZnAl
gatka knob ручка	GZ-UDINE-1-10M	GZ-UDINE-1-20M	GZ-UDINE-1-12	

Gałka TERNI  
Knob TERNI  
Ручка TERNI

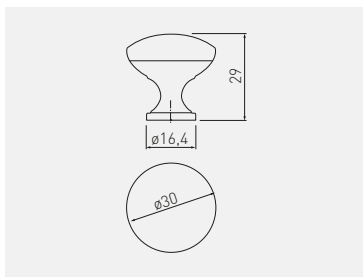

	chrom chrome хром	satyna satin сатин	aluminium aluminium алюминий	stal szorstkowana brushed steel шлифованная сталь	antyczny miedziany szorstkowany antique brushed brass античная шлифованная латунь
gałka knob ручка	GZ-TERNI-1-01	GZ-TERNI-1-02	GZ-TERNI-1-05	GZ-TERNI-1-06	GZ-TERNI-1-09



	biały white белый	czarny mat black matt чёрный матовый	czarny chrom black chrome чёрный хром	ZnAl
gałka knob ручка	GZ-TERNI-1-10	GZ-TERNI-1-20M	GZ-TERNI-1-12	ZnAl

Gałka GZ-1155  
Knob GZ-1155  
Ручка GZ-1155

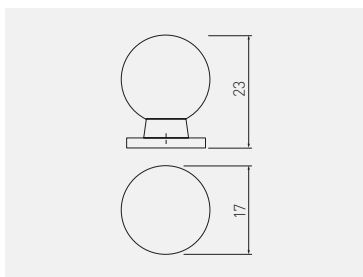

	chrom chrome хром	ZnAl
gałka knob ручка	GZ-WP1155-01	ZnAl

Uchwyt US-C1\*  
Handle US-C1\*  
Ручка US-C1\*

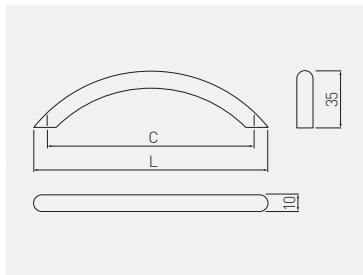

C mm	L mm		
64	74	stal szorstkowana brushed steel шлифованная сталь	stal steel сталь
96	111	US-C1-096-06	
128	145	US-C1-128-06	
160	183	US-C1-160-06	

\*Produkt dostępny na indywidualne zamówienie / Available for special orders / Товар доступен под заказ

Uchwyt US-C7\*  
Handle US-C7\*  
Ручка US-C7\*

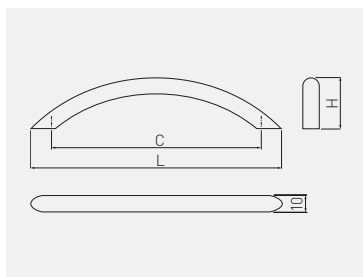





C mm	L mm	H mm			
			chrom chrome хром	stal szorstkowana brushed steel шлифованная сталь	stal steel сталь
96	119	31	US-C7-096-01	US-C7-096-06	
128	153		US-C7-128-01	US-C7-128-06	
160	188		US-C7-160-01	US-C7-160-06	
192	227		US-C7-192-01	US-C7-192-06	
224	253		US-C7-224-01	US-C7-224-06	
256	289		US-C7-256-01	US-C7-256-06	
288	325	34	US-C7-288-01	US-C7-288-06	
320	359		US-C7-320-01	US-C7-320-06	
352	406		US-C7-352-01	US-C7-352-06	

\*Produkt dostępny na indywidualne zamówienie / Available for special orders / Товар доступен под заказ.

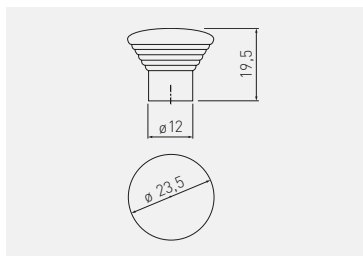
Gałka GZ-ZH\*  
Knob GZ-ZH\*  
Ручка GZ-ZH\*

CLASSIC



	 C mm				
		chrom chrome хром	satyna satin сатин	aluminium aluminium алюминий	stal szczotkowana brushed steel шлифованная сталь
gałka knob ручка		GZ-ZH-011-01A	GZ-ZH-011-02A	GZ-ZH-011-05A	GZ-ZH-011-06A
					ZnAl

\*Produkt dostępny na indywidualne zamówienie / Available for special orders / Товар доступен под заказ

Uchwyt UZ-19\*  
Handle UZ-19\*  
Ручка UZ-19\*

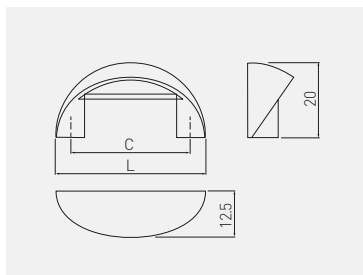

	 C mm	 L mm				
			chrom chrome хром	satyna satin сатин	stal szczotkowana brushed steel шлифованная сталь	ZnAl
	32	40	UZ-19-032-01	UZ-19-032-02	UZ-19-032-06	

\*Produkt dostępny na indywidualne zamówienie / Available for special orders / Товар доступен под заказ

Uchwyt US-U4\*  
Handle US-U4\*  
Ручка US-U4\*

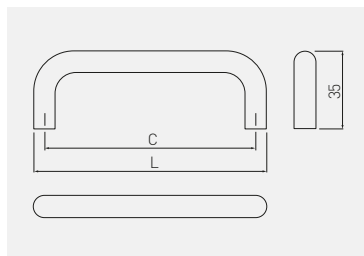

C mm	L mm			
		chrom chrome хром	stal szcztokowana brushed steel шлифованная сталь	
64	74	US-U4-064-01	US-U4-064-06	stal steel сталь
96	106	US-U4-096-01	US-U4-096-06	
128	138	US-U4-128-01	US-U4-128-06	
160	170	US-U4-160-01	US-U4-160-06	
192	202	US-U4-192-01	US-U4-192-06	
320	330	US-U4-320-01	US-U4-320-06	

\*Produkt dostępny na indywidualne zamówienie / Available for special orders / Товар доступен под заказ

Uchwyt UZ-605\*  
Handle UZ-605\*  
Ручка UZ-605\*

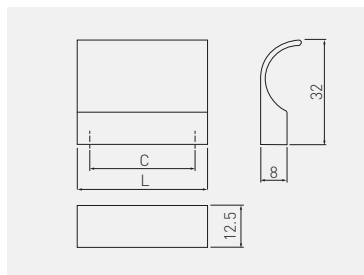

C mm	L mm			
		chrom chrome хром	aluminium aluminium алюминий	ZnAl
32	40	UZ-605032-01	UZ-605032-05	

\*Produkt dostępny na indywidualne zamówienie / Available for special orders / Товар доступен под заказ

Uchwyt TRIEST  
Handle TRIEST  
Ручка TRIEST

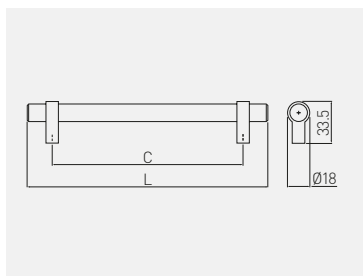

C mm	L mm		
		stal szcztokowana brushed steel шлифованная сталь	
96	136	RS-TRIES-96-06	stal, ZnAl steel, ZnAl сталь, ZnAl
128	168	RS-TRIES-128-06	
160	200	RS-TRIES-160-06	
192	232	RS-TRIES-192-06	
256	296	RS-TRIES-256-06	
320	360	RS-TRIES-320-06	





## Uchwyt RELING RS Handle RELING RS Ручка RELING RS

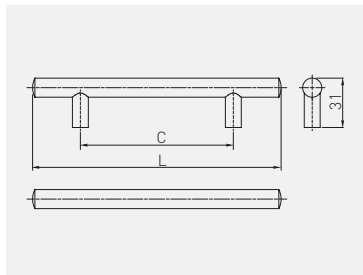

C  
mm

L  
mm



		chrom chrome хром	satyna satin сатин	aluminium aluminium алюминий	stal szorstkowana brushed steel шлифованная сталь	antyczna miedź antique copper античная медь	
96	156	RS-156096-01	RS-156096-02	RS-156096-05	RS-156096-06	RS-156096-14	
128	188	RS-188128-01	RS-188128-02	RS-188128-05	RS-188128-06	RS-188128-14	
160	220	RS-220160-01	RS-220160-02	RS-220160-05	RS-220160-06	RS-220160-14	
192	272	RS-272192-01	RS-272192-02	RS-272192-05	RS-272192-06	RS-272192-14	
224	304	RS-304224-01	RS-304224-02	RS-304224-05	RS-304224-06	RS-304224-14	
256	336	RS-336256-01	RS-336256-02	RS-336256-05	RS-336256-06	RS-336256-14	
288	368	RS-368288-01	RS-368288-02	RS-368288-05	RS-368288-06	-	stal steel
320	400	RS-400320-01	RS-400320-02	RS-400320-05	RS-400320-06	RS-400320-14	сталь
352	432	RS-432352-01	RS-432352-02	RS-432352-05	RS-432352-06	-	
384	464	RS-464384-01	RS-464384-02	RS-464384-05	RS-464384-06	-	
416	496	RS-496416-01	RS-496416-02	RS-496416-05	RS-496416-06	-	
448	528	RS-528448-01	RS-528448-02	RS-528448-05	RS-528448-06	-	
480	560	RS-560480-01	RS-560480-02	RS-560480-05	RS-560480-06	-	
512	592	RS-592512-01	RS-592512-02	RS-592512-05	RS-592512-06	-	
544	624	RS-624544-01	RS-624544-02	RS-624544-05	RS-624544-06	-	

Na indywidualne zamówienie dostępne również rozstawy: 576, 608, 640, 672, 704, 736, 768, 800 (mm).

Other sizes are available for special orders: 576, 608, 640, 672, 704, 736, 768, 800 (mm).





Под заказ доступны ручки с межцентровым расстоянием: 576, 608, 640, 672, 704, 736, 768, 800 (мм)

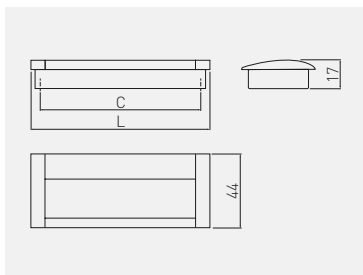

antyczna miedź  
antique copper  
античная медь

Uchwyt UA-326  
Handle UA-326  
Ручка UA-326





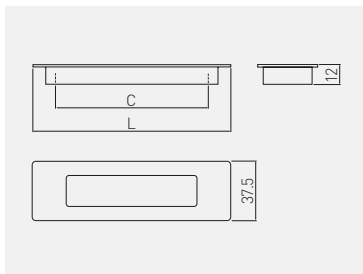

 C mm	 L mm			
		aluminium / chrom aluminium / chrome алюминий / хром	aluminium aluminium алюминий	aluminium aluminium алюминий
96	124	UA-01-326096-V1	UA-00-326096	
128	155	UA-01-326128-V1	UA-00-326128	
160	186	UA-01-326160	*	

\*Produkt dostępny na indywidualne zamówienie / Available for special orders / Товар доступен под заказ

Uchwyt UZ-E6  
Handle UZ-E6  
Ручка UZ-E6



 C mm	 L mm				
		chrom chrome хром	aluminium aluminium алюминий	stal szorstkowana brushed steel шлифованная сталь	ZnAl
96	124	UZ-E6-096-01	UZ-E6-096-05	UZ-E6-096-06	
128	155	UZ-E6-128-01	UZ-E6-128-05	UZ-E6-128-06	
160	186	UZ-E6-160-01	UZ-E6-160-05	UZ-E6-160-06	

Uchwyt B224  
Handle B224  
Ручка B224

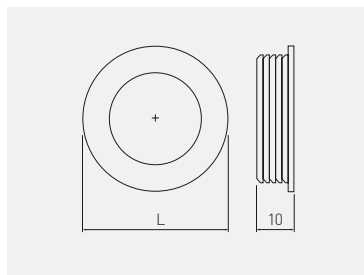

						
	chrom chrome хром	satyna satin сатин	aluminium aluminium алюминий	biały white белый	czarny black чёрный	ZnAl
40,5	UZ-00B224-01	UZ-00B224-02	UZ-00B224-05	UZ-00B224-10	UZ-00B224-20	

Uchwyt B226  
Handle B226  
Ручка B226

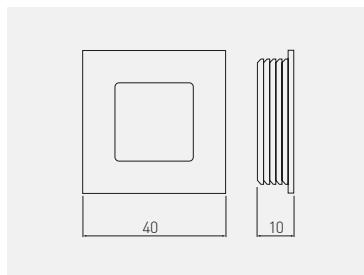

						
	chrom chrome хром	satyna satin сатин	aluminium aluminium алюминий	biały white белый	czarny black чёрный	ZnAl
40	UZ-00B226-01	UZ-00B226-02	UZ-00B226-05	UZ-00B226-10	UZ-00B226-20	

Uchwyt UZ-R132\*  
Handle UZ-R132\*  
Ручка UZ-R132\*

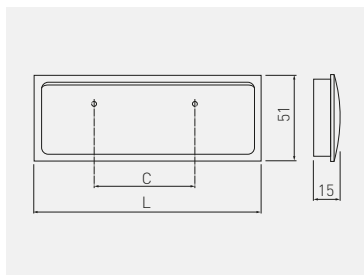

 C mm	 L mm				
		chrom chrome хром	satyna satin сатин	stal szczotkowana brushed steel шлифованная сталь	ZnAl
64	133	UZ-R132-A1-01	UZ-R132-A1-02	UZ-R132-A1-06	

\*Produkt dostępny na indywidualne zamówienie / Available for special orders / Товар доступен под заказ

Uchwyt UZ-S50\*  
Handle UZ-S50\*  
Ручка UZ-S50\*

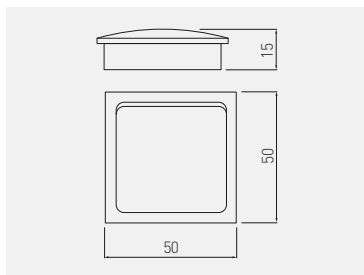

 L mm					
	chrom chrome хром	satyna satin сатин	aluminium aluminium алюминий	stal szczotkowana brushed steel шлифованная сталь	ZnAl
50	UZ-S50-A1-01	UZ-S50-A1-02	UZ-S50-A1-05	UZ-S50-A1-06	

\*Produkt dostępny na indywidualne zamówienie / Available for special orders / Товар доступен под заказ

Uchwyt HEXI  
Handle HEXI  
Ручка HEXI

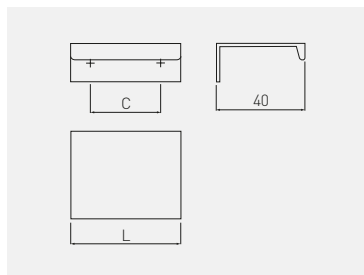

C mm	L mm					
		chrom chrome хром	aluminium aluminium алюминий	biały mat white matt белый матовый	czarny mat black matt чёрный матовый	aluminium aluminium алюминий
32	50	UA-HEXI-01	UA-HEXI-05	UA-HEXI-10M	UA-HEXI-20M	
96	150	UA-HEXI96-01	UA-HEXI96-05	UA-HEXI96-10M	UA-HEXI96-20M	



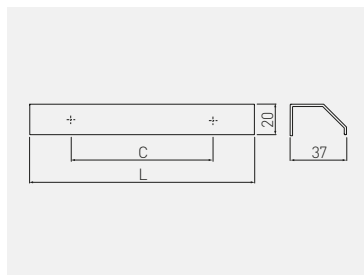

Uchwyt PAXO  
Handle PAXO  
Ручка PAXO

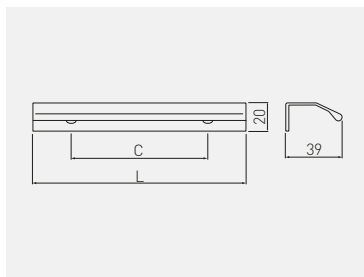

C mm	L mm		
		aluminium aluminium алюминий	aluminium aluminium алюминий
32	50	UA-PAXO-32-50-05	
96	150	UA-PAXO-96-150-05	
224	250	UA-PAXO-224-250-05	
320	350	UA-PAXO-320-350-05	
do cięcia to cut для резки	3500	UA-PAXO-3500-05	

Uchwyt TREX  
Handle TREX  
Ручка TREX



 C mm	 L mm		
		aluminium aluminium алюминий	
32	50	UA-TREX-32-50-05	aluminium aluminium алюминий
96	150	UA-TREX-96-150-05	
224	250	UA-TREX-224-250-05	
320	350	UA-TREX-320-350-05	
do cięcia to cut для резки	3500	UA-TREX-3500-05	

Uchwyt PROFIL C  
Handle PROFIL C  
Ручка PROFIL C

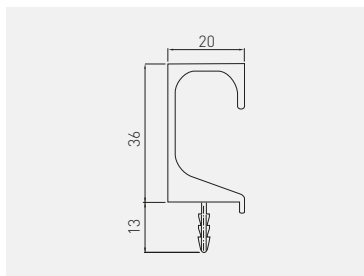



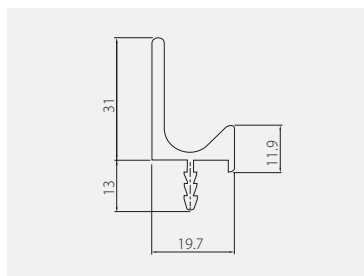

 C mm	 L mm				
		aluminium aluminium алюминий	czarny mat black matt чёрный матовый	stal szczotkowana brushed steel шлифованная сталь	aluminium aluminium алюминий
do cięcia to cut для резки	3500	PA-0242-35-50	PA-0242-35-50-20M	PA-0242-35-50-06*	

\*Produkt dostępny na indywidualne zamówienie / Available for special orders / Товар доступен под заказ

Uchwyt PROFIL L  
Handle PROFIL L  
Ручка PROFIL L





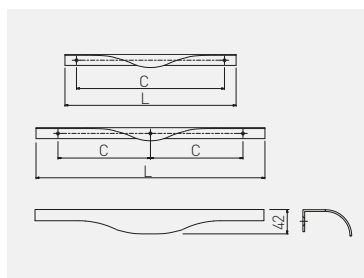

 C mm	 L mm		
		aluminium aluminium алюминий	czarny mat black matt чёрный матовый
do cięcia to cut для резки	3500	PA-0243-35-50	stal szorstkowana brushed steel шлифованная сталь
		PA-0243-35-50-20M	PA-0243-35-50-06*
			aluminium aluminium алюминий

\*Produkt dostępny na indywidualne zamówienie / Available for special orders / Товар доступен под заказ

Uchwyt METRON  
Handle METRON  
Ручка METRON



 C mm	 L mm		
		chrom chrome хром	aluminium aluminium алюминий
256	296	UA-METRO-256-296-18-01	UA-METRO-256-296-18-05
320	396	UA-METRO-320-396-18-01	UA-METRO-320-396-18-05
2 x 224*	496	UA-METRO-224-496-18-01	UA-METRO-224-496-18-05
2 x 256*	596	UA-METRO-256-596-18-01	UA-METRO-256-596-18-05
2 x 352*	796	UA-METRO-352-796-18-01	UA-METRO-352-796-18-05
			aluminium aluminium алюминий

\* Montowanie na 3 wkręty / Mounted with 3 screws / Крепление на 3 самореза

Gałka J4  
Knob J4  
Ручка J4

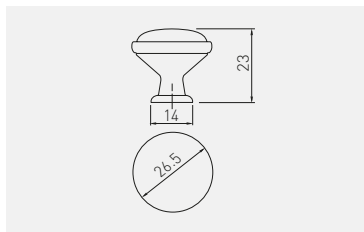

motyw pattern рисунок	antyczny mosiądz antique brass античная латунь	antyczne srebro antique silver старинное серебро	
autumn rose	GP-0728-J4-B	-	ZnAl, porcelana ZnAl, porcelain ZnAl, фарфор
spring flower	GP-0728-J4-R	-	
blue rose	GP-0728-J4-A-04	GP-0728-J4-A-07	
orient gold	GP-0728-J4-C-04	-	



autumn rose



spring flower



blue rose



orient gold

Uchwyt 728B  
Handle 728B  
Ручка 728B

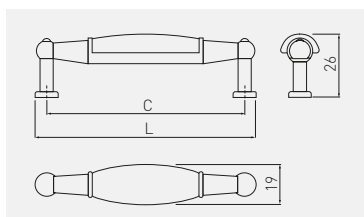

motyw pattern рисунок	C mm	L mm	antyczny mosiądz antique brass античная латунь	
spring flower	96	106	UP-WP0728-BR	ZnAl, porcelana ZnAl, porcelain ZnAl, фарфор
country	96	106	UP-WP0728-BK	
ornament	96	106	UP-WP0728-BX	
autumn rose	96	106	UP-WP0728-BB	



spring flower



country



ornament



autumn rose



Uchwyt 728P  
Handle 728P  
Ручка 728P

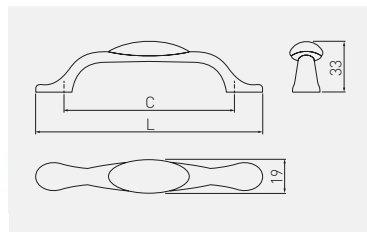

motyw pattern рисунок	C mm	L mm	antyczny mosiądz antique brass античная латунь	antyczne srebro antique silver старинное серебро	ZnAl, porcelana ZnAl, porcelain ZnAl, фарфор
blue rose	96	125	UP-WP0728-PA-04	UP-WP0728-PA-07	
orient gold	96	125	UP-WP0728-PC-04	-	
ornament	96	125	UP-WP0728-PX	-	
autumn rose	96	125	UP-WP0728-PB	-	
spring flower	96	125	UP-WP0728-PR	-	
country	96	125	UP-WP0728-PK	-	
milky	96	125	UP-WP0728-P0	-	



blue rose



orient gold



ornament



autumn rose



spring flower



country



milky

Uchwyt ALATRI  
Handle ALATRI  
Ручка ALATRI

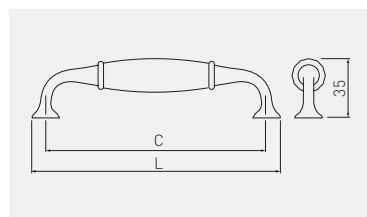

C mm	L mm	antyczny mosiądz antique brass античная латунь	ZnAl, porcelana ZnAl, porcelain ZnAl, фарфор
128	144	UZ-ALATR-128-04	

Uchwyt VASTO  
Handle VASTO  
Ручка VASTO

NEW

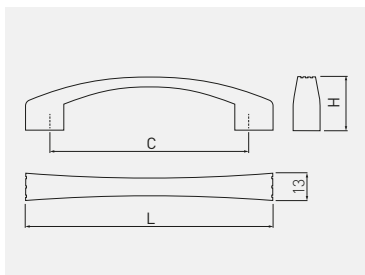

C mm	L mm	H mm		
96	120	26	antyczny mosiądz szczotkowany antique brushed brass античная шлифованная латунь	ZnAl
128	151	27	UZ-VASTO-96-09	
			UZ-VASTO-128-09	

Uchwyt PALERMO  
Handle PALERMO  
Ручка PALERMO

NEW

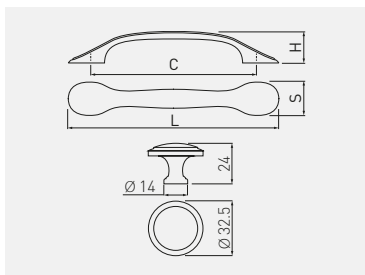

C mm	L mm	H mm	S mm		
96	127	22.5	23	antyczne srebro antique silver античное серебро	ZnAl
128	159	23	25	UZ-PALER-96-07	
				UZ-PALER-128-07	
gałka knob ручка	-	-	-	GZ-PALER-1-07	

Uchwyt BELLA  
Handle BELLA  
Ручка BELLA

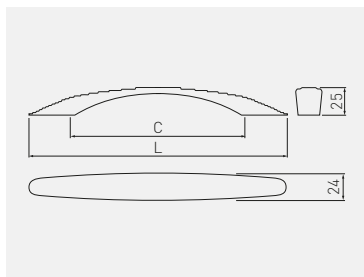

C mm	L mm		
160	236	antyczny mosiądz szczotkowany antique brushed brass античная шлифованная латунь	ZnAl
UZ-BELLA160-09			

Uchwyt UZ-10  
Handle UZ-10  
Ручка UZ-10

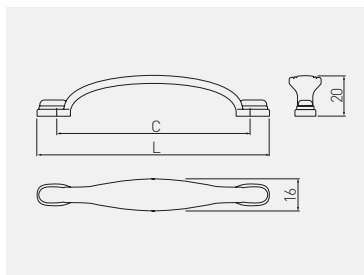

C mm	L mm		
96	120	antyczny mosiądz antique brass античная латунь	ZnAl
UZ-10-096-N04			

Uchwyt UZ-12  
Handle UZ-12  
Ручка UZ-12

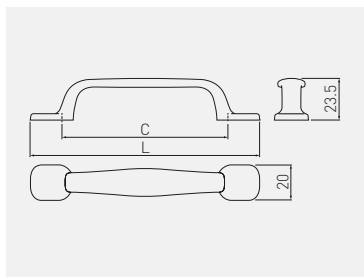

C mm	L mm		
96	131	antyczny mosiądz antique brass античная латунь	ZnAl
UZ-12-096-04			

Uchwyt WERONA  
Handle WERONA  
Ручка WERONA

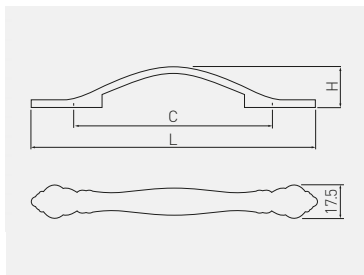

C mm	L mm	H mm				
96	148	24,5	antyczny mosiądz antique brass античная латунь	antyczny mosiądz szczotkowany antique brushed brass античная шлифованная латунь	czarny chrom black chrome чёрный хром	ZnAl
128	183	26,5	UZ-WERON-96-04	UZ-WERON-96-09	UZ-WERON-96-12	
			UZ-WERON-128-04	UZ-WERON-128-09	UZ-WERON-128-12	

Uchwyt VINCENZA  
Handle VINCENZA  
Ручка VINCENZA

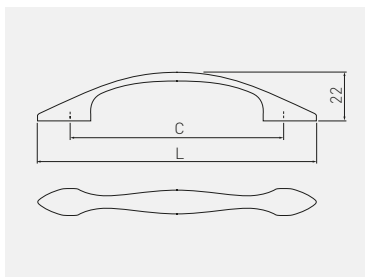

 C mm	 L mm		
96	125	antyczny mosiądz antique brass античная латунь	ZnAl
		UZ-VINCE-96-04	

Uchwyt APRILLA  
Handle APRILLA  
Ручка APRILLA

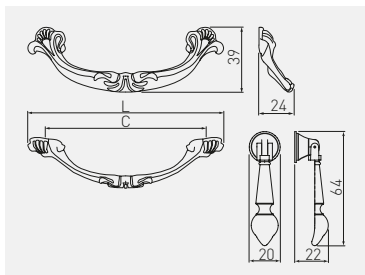

 C mm	 L mm		
96	122	antyczny mosiądz antique brass античная латунь	ZnAl
		UZ-APRIL-96-04	
kotatka knocker ручка		KT-APRIL-1-04	

Uchwyt AVELI  
Handle AVELI  
Ручка AVELI

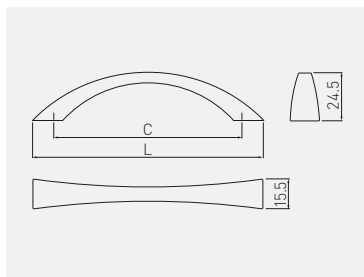

 C mm	 L mm		
96	118	antyczny mosiądz antique brass античная латунь	ZnAl
UZ-AVELI-96-04			

Uchwyt ARCHE\*  
Handle ARCHE\*  
Ручка ARCHE\*

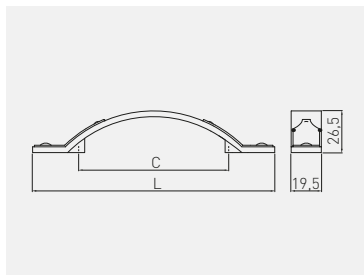

 C mm	 L mm		
96	155	antyczny mosiądz szczotkowany antique brushed brass античная шлифованная латунь	ZnAl
UZ-ARCH096-AEB			

\*Produkt dostępny na indywidualne zamówienie / Available for special orders / Товар доступен под заказ

Uchwyt AREZO  
Handle AREZO  
Ручка AREZO

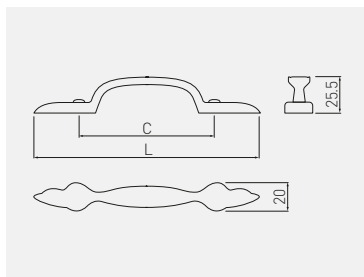

 C mm	 L mm		
		antyczny mosiądz antique brass античная латунь	ZnAl
96	160	UZ-AREZO-96-04	

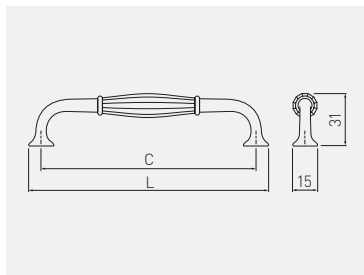

Uchwyt ABIATE  
Handle ABIATE  
Ручка ABIATE



 C mm	 L mm		
		antyczny mosiądz antique brass античная латунь	ZnAl
128	143	UZ-ABIAT-128-04	

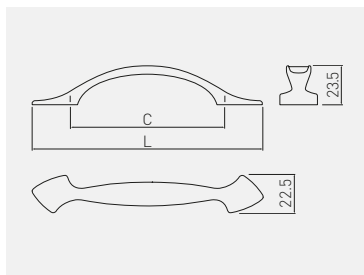



Uchwyt ADRIN  
Handle ADRIN  
Ручка ADRIN

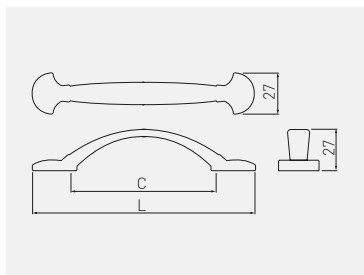

 C mm	 L mm		
96	139	antyczny mosiądz antique brass античная латунь	ZnAl
UZ-ADRIN-96-04			

Uchwyt ACERA  
Handle ACERA  
Ручка ACERA









 C mm	 L mm		
96	147	antyczny mosiądz antique brass античная латунь	ZnAl
UZ-ACERA-96-04			

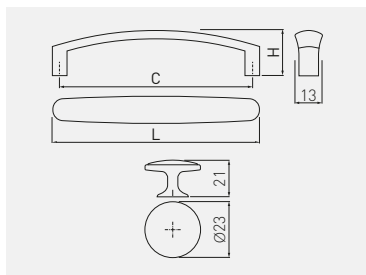

Uchwyt OLBIA  
Handle OLBIA  
Ручка OLBIA

NEW



 C mm	 L mm	 H mm		
96	103	22	antyczny mosiądz antique brass античная латунь	ZnAl
128	136	24	UZ-OLBIA-96-04	
gatka knob ручка	-	-	UZ-OLBIA-128-04	
			GZ-OLBIA-1-04	

Uchwyt LATINA  
Handle LATINA  
Ручка LATINA

NEW

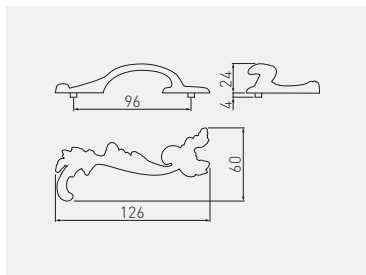

 C mm		
96	antyczny mosiądz antique brass античная латунь	ZnAl
	UZ-LATIN-96-04	

Uchwyt ANZIO  
Handle ANZIO  
Ручка ANZIO

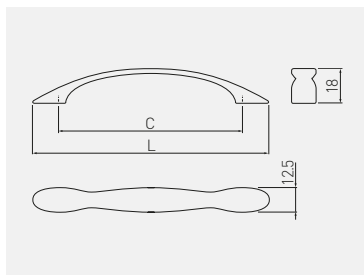

C mm	L mm		
96	123	antyczny mosiądz antique brass античная латунь	ZnAl
		UZ-ANZIO-96-04	

Uchwyt AZTEK  
Handle AZTEK  
Ручка AZTEK

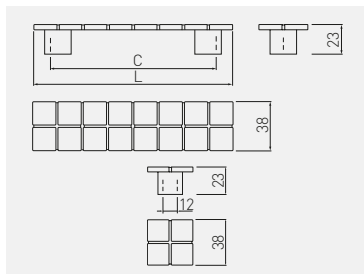

C mm	L mm		
128	155	antyczny mosiądz antique brass античная латунь	ZnAl
160	194	UZ-AZ-128-04	
gatka knob ручка	38	UZ-AZ-012-04	

Uchwyt MARSALA  
Handle MARSALA  
Ручка MARSALA

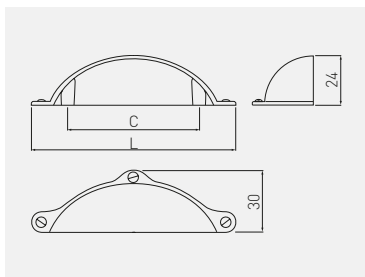

C mm	L mm				
64	99,5	antyczne srebro antique silver античное серебро	antyczny mosiądz szczotkowany antique brushed brass античная шлифованная латунь	biały mat white matt белый матовый	ZnAl
		UZ-MARSA-64-07	UZ-MARSA-64-09	UZ-MARSA-64-10M	

C mm	L mm				
64	99,5	tytan szczotkowany brushed titanium шлифованный титан	czarny mat black matt чёрный матовый		ZnAl
		UZ-MARSA-64-11	UZ-MARSA-64-20M		



Uchwyt ROYAL  
Handle ROYAL  
Ручка ROYAL

RETRO

GZ-ROYAL3-1-10/03



UZ-ROYAL4-96-03



UZ-ROYAL1-96-10/03



UZ-ROYAL2-96-10/03



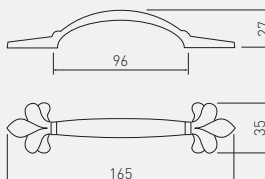
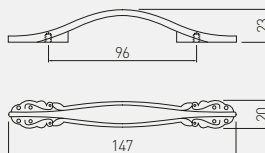
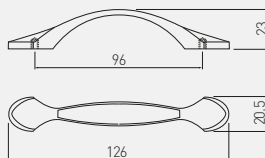
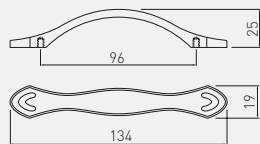
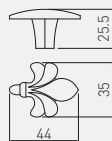

UZ-ROYAL3-96-10/03

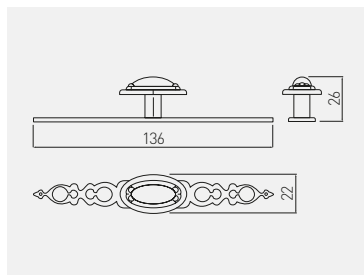

	C mm	L mm		
motyw pattern рисунок			biały / złoty white / gold белый / золото	
latina	96	126	UZ-ROYAL1-96-10/03	ZnAl
werona	96	147	UZ-ROYAL2-96-10/03	
genova	96	165	UZ-ROYAL3-96-10/03	
reggio	96	134	UZ-ROYAL4-96-03	
genova	gałka knob ручка	35	GZ-ROYAL3-1-10/03	

Gałka UZ-WP146  
Knob UZ-WP146  
Ручка UZ-WP146



 C mm		
	antyczny mosiądz antique brass античная латунь	ZnAl
gałka knob ручка	UZ-WP1146-04	

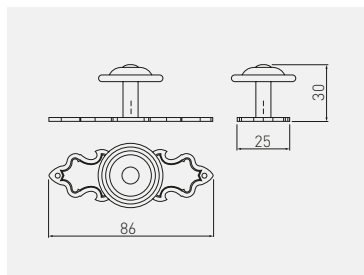

Gałka GZ-1136  
Knob GZ-1136  
Ручка GZ-1136

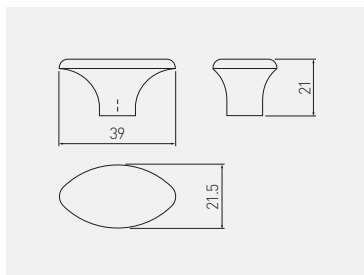

 C mm		
	antyczny mosiądz antique brass античная латунь	ZnAl
gałka knob ручка	GZ-WP1136-04	

Gałka GZ-1148  
Knob GZ-1148  
Ручка GZ-1148



C mm		
gatka knob ручка	antyczny mosiądz antique brass античная латунь	ZnAl
	GZ-WP1148-04	

Gałka GZ-1152\*  
Knob GZ-1152\*  
Ручка GZ-1152\*

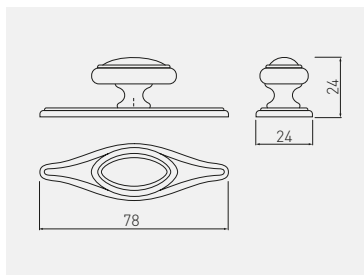

C mm		
gatka knob ручка	antyczny mosiądz antique brass античная латунь	ZnAl
	GZ-WP1152-04	

\*Produkt dostępny na indywidualne zamówienie / Available for special orders / Товар доступен под заказ

Uchwyt RENNES  
Handle RENNES  
Ручка RENNES



C mm	L mm		
		antyczny mosiądz antique brass античная латунь	ZnAl
96	121	UZ-REN096-04A	
kołatka knocker ручка		UZ-RENG02-04A	
gałka knob ручка		UZ-RENG01-04A	

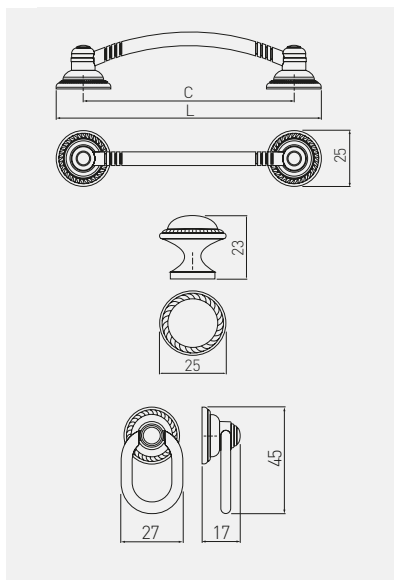



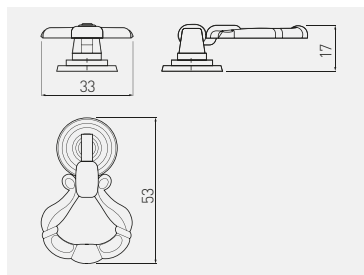

Kołatka KT-1147  
Knocker KT-1147  
Ручка KT-1147

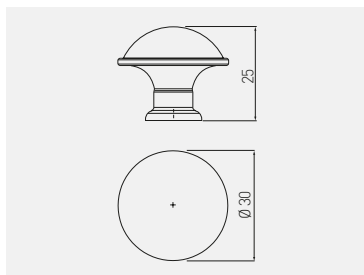

C mm		
	antyczny mosiądz antique brass античная латунь	ZnAl
kołatka knocker ручка	KT-WP1147-04	

Gałka FROSINO  
Knob FROSINO  
Ручка FROSINO



			
	antyczny mosiądz antique brass античная латунь	antyczny mosiądz szczotkowany antique brushed brass античная шлифованная латунь	ZnAl
gałka knob ручка	GZ-FROSI-1-04	GZ-FROSI-1-09	

Gałka CENTO  
Knob CENTO  
Ручка CENTO

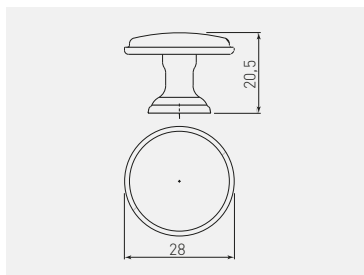

			
	antyczny mosiądz antique brass античная латунь	antyczne srebro antique silver античное серебро	czarny mat black matt чёрный матовый
gałka knob ручка	GZ-CENTO-1-04	GZ-CENTO-1-07	GZ-CENTO-1-20M



Gałka IMPERIA  
Knob IMPERIA  
Ручка IMPERIA

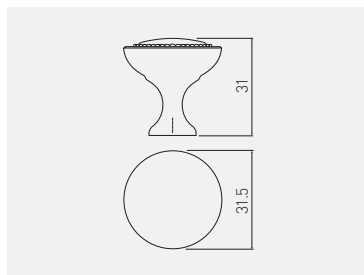





 C mm				
	satyna satin сатин	tytan szczotkowany brushed titanium шлифованный титан	czarny mat black matt чёрный матовый	aluminium aluminium алюминий
gałka knob ручка	GA-IMPER-1-02B	GA-IMPER-1-11	GA-IMPER-1-20M	

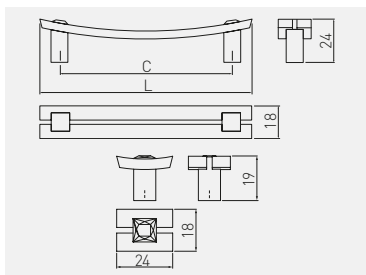
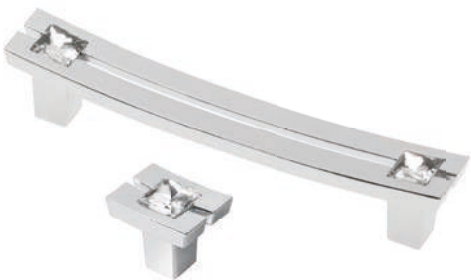





Uchwyt UZ-71C  
Handle UZ-71C  
Ручка UZ-71C

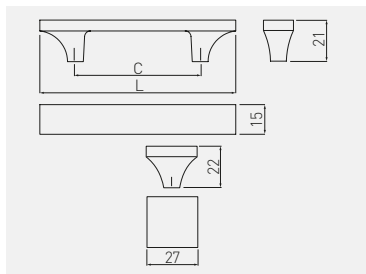

 C mm	 L mm		
96	118	chrom chrome хром	ZnAl
gatka knob ручка		GZ-71C024-01	





Uchwyt UZ-02C  
Handle UZ-02C  
Ручка UZ-02C

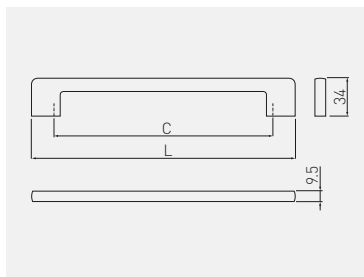

 C mm	 L mm		
64	99	chrom chrome хром	ZnAl, szkło
96	135	UZ-02C096-01	ZnAl, glass
gatka knob ручка	27	UZ-02CF27-01	ZnAl, стекло





Uchwyt UZ-CRA14  
Handle UZ-CRA14  
Ручка UZ-CRA14

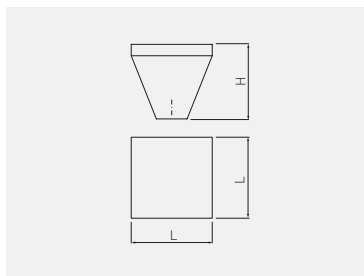

 C mm	 L mm		
		chrom chrome хром	ZnAl
128	166	UZ-CRA14-128	
192	230	UZ-CRA14-192	
320	358	UZ-CRA14-320	

Gałka UZ-CR0  
Knob UZ-CR0  
Ручка UZ-CR0







 C mm	 L mm	 H mm		
			chrom chrome хром	ZnAl
gałka knob ручка	30	28,5	UZ-CR0333-A1*	
	25	23	UZ-CR0333-B1	

\*Produkt dostępny na indywidualne zamówienie / Available for special orders / Товар доступен под заказ

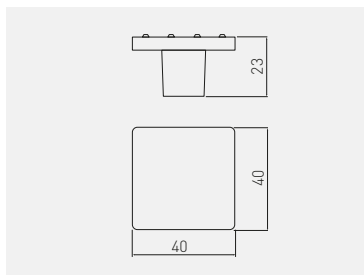
Gałka IZIS  
Knob IZIS  
Ручка IZIS





GLAMOUR

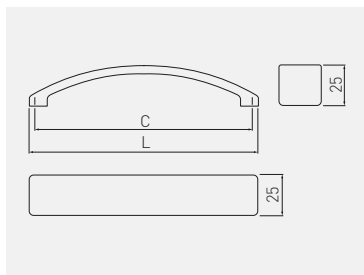

 C mm	 L mm		
		chrom chrome хром	tytan szczotkowy brushed titanium шлифованный титан
gatka knob ручка	40	UZ-IZIS40-01	UZ-IZIS40-11
ZnAl			





Uchwyt ERIS  
Handle ERIS  
Ручка ERIS

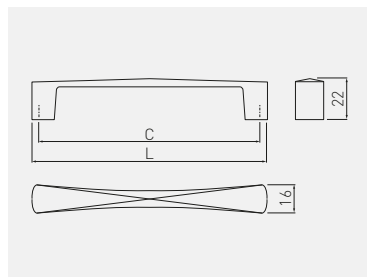

 C mm	 L mm		
		chrom chrome хром	tytan szczotkowy brushed titanium шлифованный титан
128	142	UZ-ERIS128-01	UZ-ERIS128-11
ZnAl			







Uchwyt COMO  
Handle COMO  
Ручка COMO

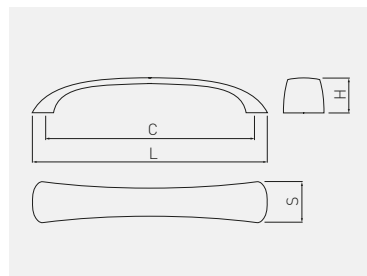

 C mm	 L mm		
		chrom chrome хром	ZnAl
96	104	UZ-COMO096-01	
128	135	UZ-COMO128-01	
160	170	UZ-COMO160-01	

Uchwyt SIENNA  
Handle SIENNA  
Ручка SIENNA



 C mm	 L mm	 H mm	 S mm		
				chrom chrome хром	ZnAl
96	111	21	23,5	UZ-SIENNA096-01	
128	142	23	25	UZ-SIENNA128-01	
160	186	24,5	26,5	UZ-SIENNA160-01	

Uchwyt LUCCA  
Handle LUCCA  
Ручка LUCCA

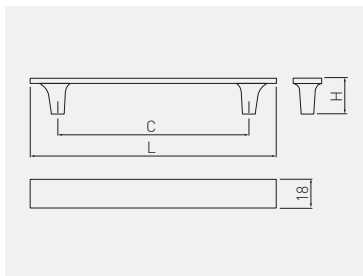

C mm	L mm	H mm		
			chrom chrome хром	ZnAl
96	131	22,5	UZ-LUCCA096-01	
128	163	23	UZ-LUCCA128-01	
160	196	23	UZ-LUCCA160-01	
192	228	23,5	UZ-LUCCA192-01	
224	260	24,5	UZ-LUCCA224-01	
256	292	25	UZ-LUCCA256-01	

Uchwyt BIANCA  
Handle BIANCA  
Ручка BIANCA

NEW

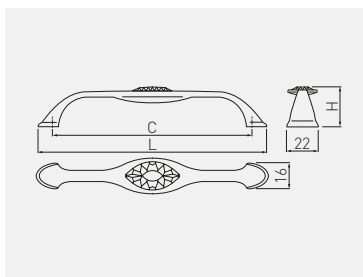

C mm	L mm	H mm		
			chrom chrome хром	ZnAl
96	114	25	UZ-BIANC-96-01	
128	146	26	UZ-BIANC-128-01	



Gałka GZ—CRPA  
Knob GZ—CRPA  
Ручка GZ—CRPA

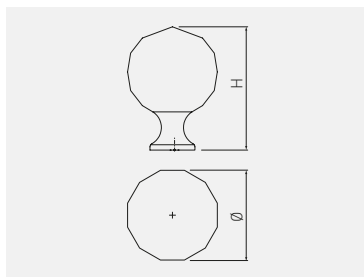

		chrom / biały kryształ chrome / white crystal хром / белый кристалл	chrom / czarny kryształ chrome / black crystal хром / чёрный кристалл	mosiądz / biały kryształ brass / white crystal латунь / белый кристалл	
20	33	GZ-CRPA20-01	GZ-CRPA20-A1	GZ-CRPA20-03	ZnAl, szkło ZnAl, glass ZnAl, стекло
25	37	GZ-CRPA25-01	GZ-CRPA25-A1	GZ-CRPA25-03	
30	44	GZ-CRPA30-01	GZ-CRPA30-A1	GZ-CRPA30-03	
40	55	GZ-CRPA40-01	GZ-CRPA40-A1	GZ-CRPA40-03	

Gałka GZ—CRPB  
Knob GZ—CRPB  
Ручка GZ—CRPB

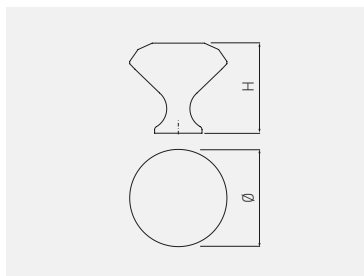

		chrom / biały kryształ chrome / white crystal хром / белый кристалл	chrom / czarny kryształ chrome / black crystal хром / чёрный кристалл	mosiądz / biały kryształ brass / white crystal латунь / белый кристалл	
20	26	GZ-CRPB20-01	GZ-CRPB20-A1	GZ-CRPB20-03	ZnAl, szkło ZnAl, glass ZnAl, стекло
25	28	GZ-CRPB25-01	GZ-CRPB25-A1	GZ-CRPB25-03	
30	30	GZ-CRPB30-01	GZ-CRPB30-A1	GZ-CRPB30-03	
40	38	GZ-CRPB40-01	GZ-CRPB40-A1	GZ-CRPB40-03	



Gatka GZ—CRPC  
 Knob GZ—CRPC  
 Ручка GZ—CRPC

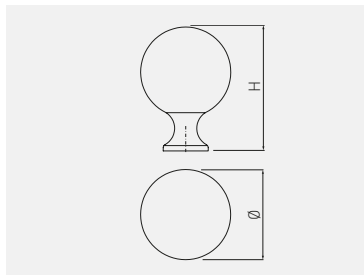

 mm	 mm		
		chrom / biały kryształ chrome / black crystal хром / белый кристалл	chrom / czarny kryształ chrome / black crystal хром / чёрный кристалл
30	43	GZ-CRPC30-01	GZ-CRPC30-A1
40	54	GZ-CRPC40-01	GZ-CRPC40-A1
ZnAl, szkło ZnAl, glass ZnAl, стекло			



Uchwyt KID WILD  
Handle KID WILD  
Ручка KID WILD



UM-KID-I-002



UM-KID-P-001



UM-KID-Q-001



UM-KID-S-001



UM-KID-U-001



UM-KID-Y-001



tygrys / tiger / тигр	UM-KID-I-002	guma, ZnAl rubber, ZnAl резина, ZnAl
stoń / elephant / слон	UM-KID-P-001	
krokodyl / crocodile / крокодил	UM-KID-Q-001	
hipopotam / hippo / бегемот	UM-KID-S-001	
panda / panda / панда	UM-KID-U-001	
pingwin / penguin / пингвин	UM-KID-Y-001	

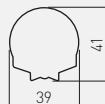
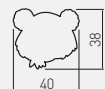
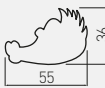

Uchwyt KID PLAY  
Handle KID PLAY  
Ручка KID PLAY



UM-KID-C-001



UM-KID-G-001



UM-KID-E-001



UM-KID-D-001



UM-KID-F-001



kwiatek / flower / цветок	UM-KID-C-001	guma, ZnAl rubber, ZnAl резина, ZnAl
kwiatek / flower / цветок	UM-KID-G-001	
samochód / car / автомобиль	UM-KID-D-001	
piłka / ball / мяч	UM-KID-E-001	
kwadrat / square / квадрат	UM-KID-F-001	

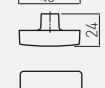
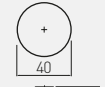
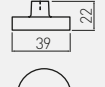
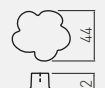

Uchwyt KID FARM  
Handle KID FARM  
Ручка KID FARM



UM-KID-A-001



UM-KID-B-001



UM-KID-I-001



UM-KID-O-001



UM-KID-T-001



UM-KID-W-001



UM-KID-X-001



UM-KID-Z-001



rybka / fish / рыба	UM-KID-A-001	guma, ZnAl rubber, ZnAl резина, ZnAl
ślimak / snail / улитка	UM-KID-B-001	
kotek / kitten / котенок	UM-KID-I-001	
kura / hen / курица	UM-KID-O-001	
krówka / cow / корова	UM-KID-T-001	
konik / horse / лошадь	UM-KID-W-001	
królik / rabbit / кролик	UM-KID-X-001	
piesek / dog / собака	UM-KID-Z-001	

# Chcesz sprawdzić jak wygląda uchwyt na frontach mebli przed zakupem? Do you want to check how your piece of furniture will look with GTV handles? Хочешь проверить как будут смотреться ручки GTV в интерьере?



1

**KROK**

Ściągnij i zainstaluj aplikację ze strony: [www.uchwyty.gtv.com.pl](http://www.uchwyty.gtv.com.pl) lub ze sklepów googleplay i appstore – aplikacja **VIEW AT HOME**.

**STEP**

Download and install the app for the site: [www.uchwyty.gtv.com.pl](http://www.uchwyty.gtv.com.pl) or from the google play store or appstore – the app is called **VIEW AT HOME**.

**ШАГ**

Скачай и установи бесплатное приложение с [www.uchwyty.gtv.com.pl](http://www.uchwyty.gtv.com.pl) для смартфонов с операционной системой Android и IOS

↓ Pobierz za darmo

Download for free

Скачайте бесплатно



Uruchom aplikację  
Start the app  
Запустите приложение

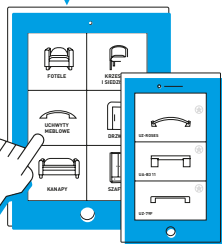

2

**KROK**

Wybierz kategorię uchwytów meblowych i dobrać odpowiedni model uchwytu.

**STEP**

Select the category of furniture handles and select desired model

**ШАГ**

Выбери модель ручки

Wyświetl uchwyt  
Display a handle  
Посмотреть

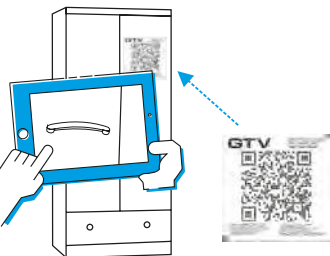

3

**KROK**

Naklej marker na froncie mebla, skieruj kamerę urządzenia na marker, i zobacz jak wygląda wybrany uchwyt na meblu.

**STEP**

Attach the marker on the furniture front, direct the device's camera onto the marker and see how the selected handle looks on the furniture front

**ШАГ**

Прикрепи конфигуратор к мебельному фасаду. Проверьте как ручка смотрится в интерьере



Wytnij poniższy marker  
Cut out the marker below  
Вырежьте конфигурактор

# GTV

1. ŚCIĄGNIJ I ZAINSTALUJ APLIKACJĘ ZE STRONY
2. WYBIERZ KATEGORIĘ UCHWYTÓW MEBLOWYCH
3. DOBIERZ ODPOWIADAJĄCY CI MODEL
4. NAKLEJ ZNACZNIK NA FRONCIE MEBLA I ZAARANŻUJ GO WYBRANYM UCHWYTEM

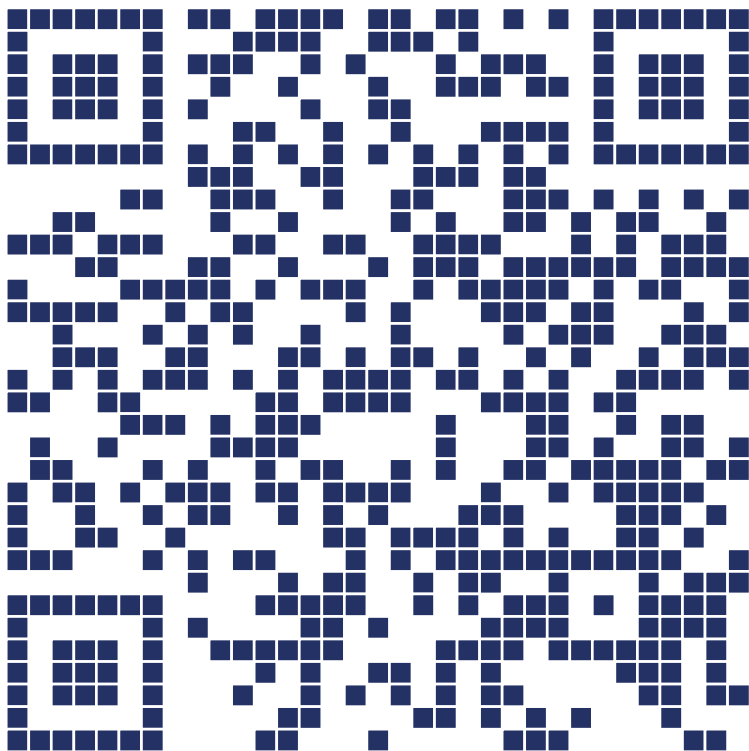

1. DOWNLOAD AND INSTALL APP FORM THE WEBSITE
2. CHOOSE A CATEGORY OF FURNITURE HANDLES
3. SELECT THE DESIRED FURNITURE HANDLE MODEL
4. STICK THE MARKER ON THE FRONT PANEL OF YOUR FURNITURE PIECE, ARRANGE IT WITH YOUR SELECTED HANDLE

1. СКАЧАЙТЕ И УСТАНОВИТЕ ПРОГРАММУ НА СМАРТФОН ИЛИ ПЛАНШЕТ
2. ВЫБЕРИТЕ ИНТЕРЕСУЮЩУЮ ВАС КАТЕГОРИЮ
3. ВЫБЕРИТЕ ПОНРАВИВШУЮСЯ ВАМ РУЧКУ
4. ПРИКРЕПИТЕ КОНФИГУРАТОР К МЕБЕЛЬНОМУ ФАСАДУ И ПРОВЕРЬТЕ КАК РУЧКА СМОТРИТСЯ В ИНТЕРЬЕРЕ

Wieszak SOLO\*  
 Hook SOLO\*  
 Крючок SOLO\*

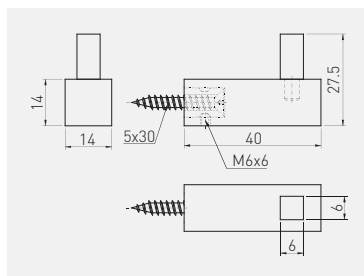

WS-SOLO-14-06



stal szczotkowana / brushed steel / шлифованная сталь



stal / steel / сталь

\*Dostępny na zamówienie / Available only for individual order / Доступен под заказ

Wieszak QUADRO\*  
 Hook QUADRO\*  
 Крючок QUADRO\*

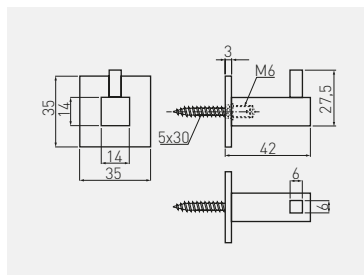

WS-QUAD-14-06



stal szczotkowana / brushed steel / шлифованная сталь



stal / steel / сталь

\*Dostępny na zamówienie / Available only for individual order / Доступен под заказ

Wieszak RONDO\*  
Hook RONDO\*  
Крючок RONDO\*

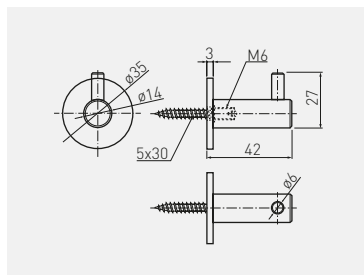

WS-ROND-14-06



stal szczotkowana / brushed steel / шлифованная сталь



stal / steel / сталь

\*Dostępny na zamówienie / Available only for individual order / Доступен под заказ

Wieszak 804  
Hook 804  
Крючок 804

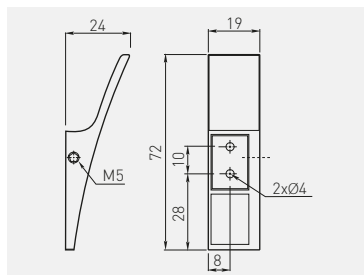

WZ-804-20-01

chrom / chrome / хром

WZ-804-20-05

aluminium / aluminium / алюминий

WZ-804-20-06

stal szczotkowana / brushed steel / шлифованная сталь



ZnAl

Wieszak TOLEDO A0  
Hook TOLEDO A0  
Крючок TOLEDO A0

NEW

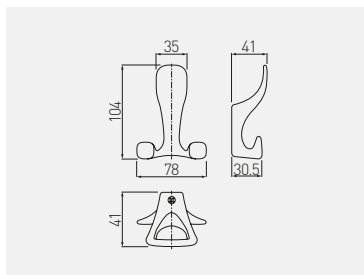

WZ-TOLED-A0-01	chrom / chrome / хром	ZnAl
WZ-TOLED-A0-02	satyna / satin / сатин	
WZ-TOLED-A0-05	aluminium / aluminium / алюминий	
WZ-TOLED-A0-06	stal szczotkowana / brushed steel / шлифованная сталь	

Wieszak TOLEDO B0  
Hook TOLEDO B0  
Крючок TOLEDO B0

NEW

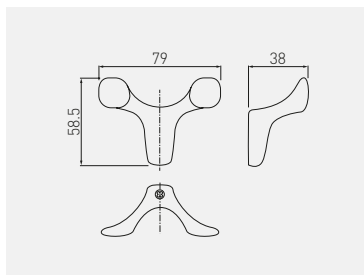

WZ-TOLED-B0-01	chrom / chrome / хром	ZnAl
WZ-TOLED-B0-02	satyna / satin / сатин	
WZ-TOLED-B0-05	aluminium / aluminium / алюминий	
WZ-TOLED-B0-06	stal szczotkowana / brushed steel / шлифованная сталь	



Wieszak TOLEDO C0  
 Hook TOLEDO C0  
 Крючок TOLEDO C0

NEW

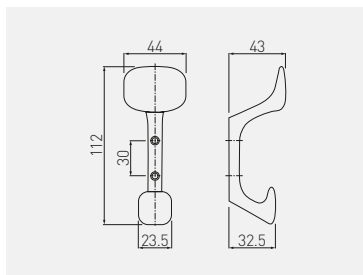

WZ-TOLED-C0-01	chrom / chrome / хром	ZnAl
WZ-TOLED-C0-02	satyna / satin / сатин	
WZ-TOLED-C0-05	aluminium / aluminium / алюминий	
WZ-TOLED-C0-06	stal szczotkowana / brushed steel / шлифованная сталь	



Wieszak K2201  
Hook K2201  
Крючок K2201

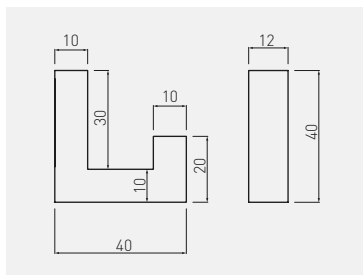

WZ-K2201-01	chrom / chrome / хром	ZnAl
WZ-K2201-06	stal szczotkowana / brushed steel / шлифованная сталь	
WZ-K2201-CZ	czarny / black / чёрный	
WZ-K2201-ZL	zielony / green / зелёный	
WZ-K2201-NB	niebieski / blue / синий	
WZ-K2201-PM	pomarańczowy / orange / оранжевый	
WZ-K2201-RZ	różowy / pink / розовый	
WZ-K2201-CS	kremowy / creamy / кремовый	

Wieszak K2202  
Hook K2202  
Крючок K2202

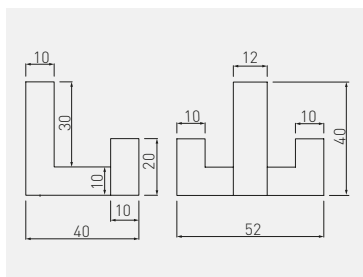

WZ-K2202-01	chrom / chrome / хром	ZnAl
WZ-K2202-06	stal szczotkowana / brushed steel / шлифованная сталь	
WZ-K2202-CZ	czarny / black / чёрный	
WZ-K2202-ZL	zielony / green / зелёный	
WZ-K2202-NB	niebieski / blue / синий	
WZ-K2202-PM	pomarańczowy / orange / оранжевый	
WZ-K2202-RZ	różowy / pink / розовый	
WZ-K2202-CS	kremowy / creamy / кремовый	

Wieszak K23-A0  
Hook K23-A0  
Крючок K23-A0

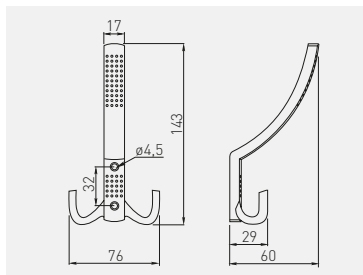

WZ-A0-K23-01	chrom / chrome / хром	ZnAl
WZ-A0-K23-02	satyna / satin / сатин	
WZ-A0-K23-03	mosiądz / brass / латунь	
WZ-A0-K23-04	antyczny mosiądz / antique brass / античная латунь	
WZ-A0-K23-05	aluminium / aluminium / алюминий	
WZ-A0-K23-20	czarny mat / black matt / чёрный матовый	

Wieszak K23-B0  
Hook K23-B0  
Крючок K23-B0

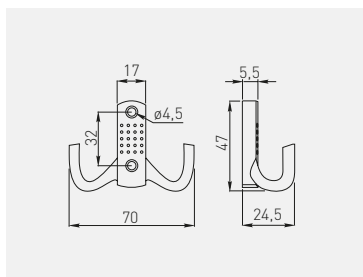

WZ-B0-K23-01	chrom / chrome / хром	ZnAl
WZ-B0-K23-02	satyna / satin / сатин	
WZ-B0-K23-03	mosiądz / brass / латунь	
WZ-B0-K23-04	antyczny mosiądz / antique brass / античная латунь	
WZ-B0-K23-05	aluminium / aluminium / алюминий	
WZ-B0-K23-20	czarny mat / black matt / чёрный матовый	

Wieszak K23-D1\*  
Hook K23-D1\*  
Крючок K23-D1\*

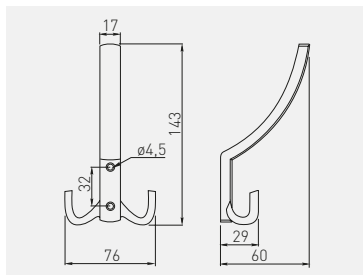

WZ-K23-D1-01	chrom / chrome / хром	ZnAl
WZ-K23-D1-02	satyna / satin / сатин	
WZ-K23-D1-03	mosiądz / brass / латунь	
WZ-K23-D1-05	aluminium / aluminium / алюминий	
WZ-K23-D1-06	stal szczotkowana / brushed steel / шлифованная сталь	

\*Dostępny na zamówienie / Available only for individual order / Доступен под заказ

Wieszak K23-E1\*  
Hook K23-E1\*  
Крючок K23-E1\*

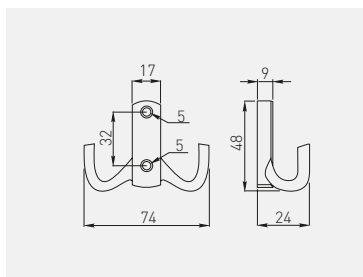

WZ-K23-E1-01	chrom / chrome / хром	ZnAl
WZ-K23-E1-02	satyna / satin / сатин	
WZ-K23-E1-03	mosiądz / brass / латунь	
WZ-K23-E1-05	aluminium / aluminium / алюминий	
WZ-K23-E1-06	stal szczotkowana / brushed steel / шлифованная сталь	

\*Dostępny na zamówienie / Available only for individual order / Доступен под заказ

Wieszak K24-A0  
Hook K24-A0  
Крючок K24-A0

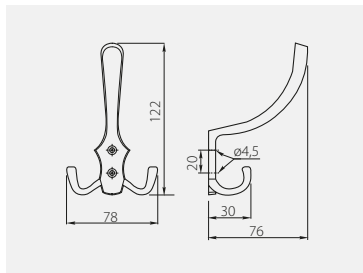

WZ-A0-K24-01	chrom / chrome / хром	ZnAl
WZ-A0-K24-02	satyna / satin / сатин	
WZ-A0-K24-03	mosiądz / brass / латунь	
WZ-A0-K24-04	antyczny mosiądz / antique brass / античная латунь	
WZ-A0-K24-05	aluminium / aluminium / алюминий	
WZ-A0-K24-20	czarny mat / black matt / чёрный матовый	

Wieszak K24-B0  
Hook K24-B0  
Крючок K24-B0

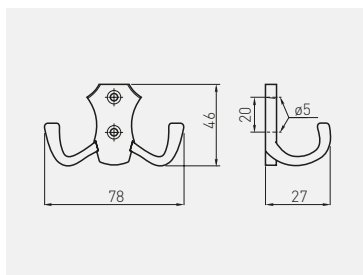

WZ-B0-K24-01	chrom / chrome / хром	ZnAl
WZ-B0-K24-02	satyna / satin / сатин	
WZ-B0-K24-03	mosiądz / brass / латунь	
WZ-B0-K24-04	antyczny mosiądz / antique brass / античная латунь	
WZ-B0-K24-05	aluminium / aluminium / алюминий	
WZ-B0-K24-20	czarny mat / black matt / чёрный матовый	

Wieszak K24-C0  
Hook K24-C0  
Крючок K24-C0

CLASSIC

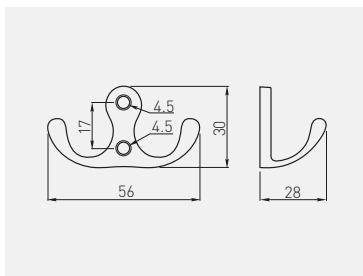

WZ-C0-K24-01	chrom / chrome / хром	ZnAl
WZ-C0-K24-02	satyna / satin / сатин	
WZ-C0-K24-03	mosiądz / brass / латунь	
WZ-C0-K24-04	antyczny mosiądz / antique brass / античная латунь	
WZ-C0-K24-05	aluminium / aluminium / алюминий	
WZ-C0-K24-20	czarny mat / black matt / чёрный матовый	

Wieszak MALAGA A0  
Hook MALAGA A0  
Крючок MALAGA A0

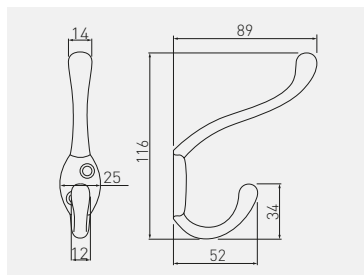

WA-MALAG-A0-01	chrom / chrome / хром	aluminium / aluminium / алюминий
WA-MALAG-A0-02	satyna / satin / сатин	
WA-MALAG-A0-05	aluminium / aluminium / алюминий	
WA-MALAG-A0-20	czarny / black / чёрный	

Wieszak MALAGA B0  
Hook MALAGA B0  
Крючок MALAGA B0

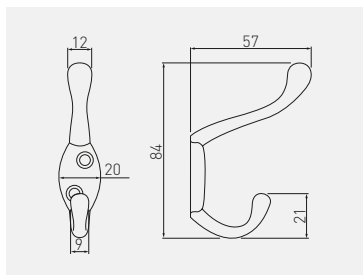

WA-MALAG-B0-01	chrom / chrome / хром	aluminium / aluminium / алюминий
WA-MALAG-B0-02	satyna / satin / сатин	
WA-MALAG-B0-05	aluminium / aluminium / алюминий	
WA-MALAG-B0-20	czarny / black / чёрный	

Wieszak MALAGA C0  
Hook MALAGA C0  
Крючок MALAGA C0

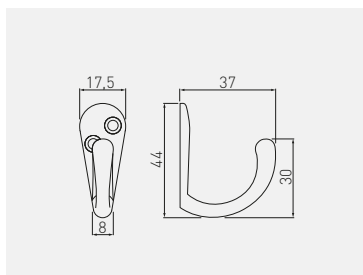



WZ-MALAG-C0-01	chrom / chrome / хром	ZnAl
WZ-MALAG-C0-02	satyna / satin / сатин	
WZ-MALAG-C0-05	aluminium / aluminium / алюминий	
WZ-MALAG-C0-20	czarny / black / чёрный	

Wieszak E18  
Hook E18  
Крючок E18

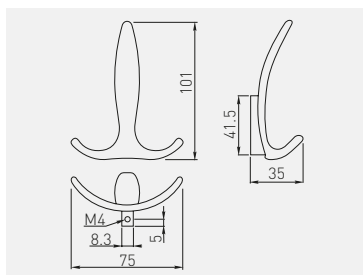

CLASSIC

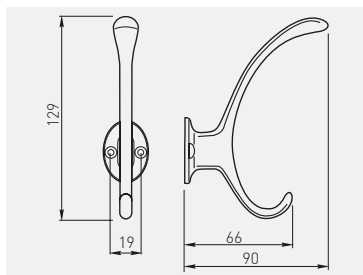

		
WZ-E-018-01	chrom / chrome / хром	ZnAl
WZ-E-018-02	satyna / satin / сатин	
WZ-E-018-05	aluminium / aluminium / алюминий	
WZ-E-018-06	stal szczotkowana / brushed steel / шлифованная сталь	

Wieszak D892  
Hook D892  
Крючок D892



		
WZ-D-892-02	satyna / satin / сатин	ZnAl
WZ-D-892-05	aluminium / aluminium / алюминий	



Wieszak ORVIETO A0  
Hook ORVIETO A0  
Крючок ORVIETO A0

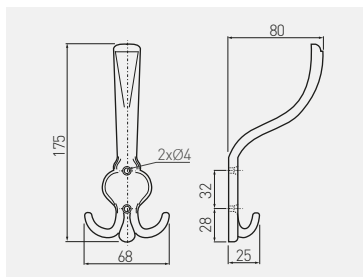

WZ-ORVIE-A0-09



antyczny mosiądz szczotkowany  
antique brushed brass  
античная шлифованная латунь



ZnAl

Wieszak ORVIETO B0  
Hook ORVIETO B0  
Крючок ORVIETO B0

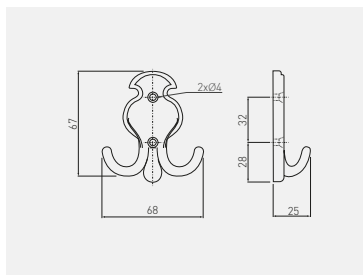

WZ-ORVIE-B0-09



antyczny mosiądz szczotkowany  
antique brushed brass  
античная шлифованная латунь



ZnAl

Wieszak K24  
Hook K24  
Крючок K24

RETRO

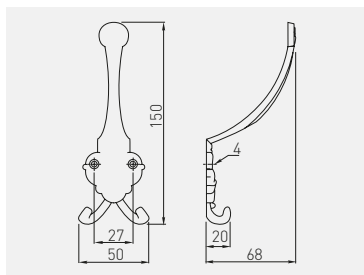

WZ-00-K24-04





antyczny mosiądz / antique brass / античная латунь

ZnAl

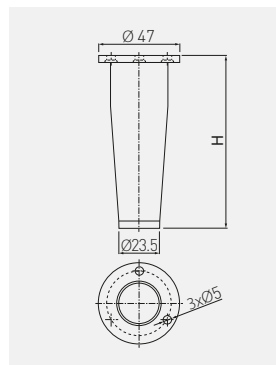





Nóżka B-103  
Leg B-103  
Ножка B-103

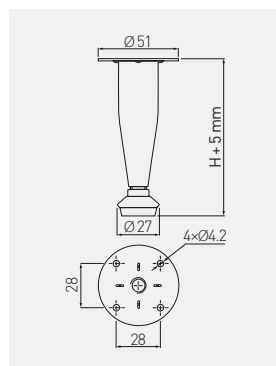

	 H mm		
NM-B103-80-01	80	chrom / chrome / хром	ZnAl
NM-B103-80-06		stal szczotkowana / brushed steel / шлифованная сталь	
NM-B103-100-01	100	chrom / chrome / хром	
NM-B103-100-06		stal szczotkowana / brushed steel / шлифованная сталь	
NM-B103-120-01	120	chrom / chrome / хром	
NM-B103-120-06		stal szczotkowana / brushed steel / шлифованная сталь	

Nóżka BD-03  
Leg BD-03  
Ножка BD-03



	 H mm		
NM-BD-003-01	100	chrom / chrome / хром	stal / steel / сталь
NM-BD-003-02		satyna / satin / сатин	
NM-BD-003-150-01	150	chrom / chrome / хром	
NM-BD-003-150-02		satyna / satin / сатин	

Nóżka BD-780  
Leg BD-780  
Ножка BD-780

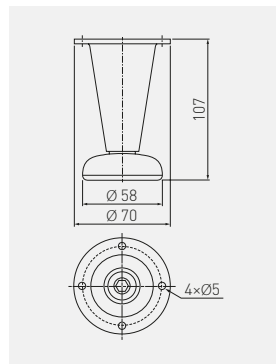

NM-BD-780-M1	107	chrom / chrome / хром	stal / steel / сталь
NM-BD-780-M2		satyna / satin / сатин	
NM-BD-780-M5		aluminium / aluminium / алюминий	

Nóżka B-140  
Leg B-140  
Ножка B-140

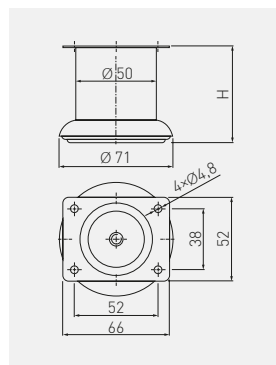





NM-B-140-060	60	chrom chrome хром	stal, tworzywo steel, plastic сталь, пластмасса
NM-B-140-080	80		
NM-B-140-100	100		
NM-B-140-120*	120		
NM-B-140-150*	150		
NM-B-140-180*	180		
NM-B-140-200*	200		

\*Dostępny na zamówienie / Available only for individual order / Доступен под заказ

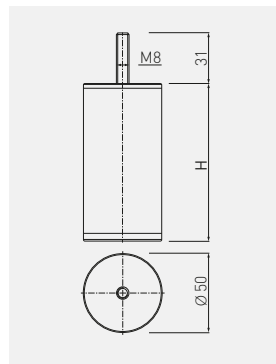
Nóżka STR-50  
Leg STR-50  
Ножка STR-50

NEW





	 mm		
NM-STR50-100-01	100	chrom / chrome / хром	stal, tworzywo steel, plastic сталь, пластмасса
NM-STR50-120-01	120		
NM-STR50-150-01	150		

Nóżka STR-60  
Leg STR-60  
Ножка STR-60

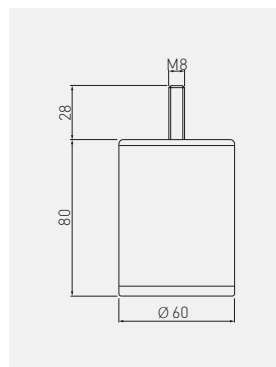



NEW

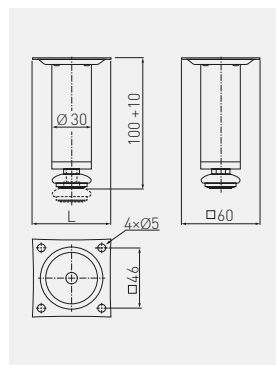

	 mm		
NM-STR60-80-01	80	chrom chrome хром	stal, tworzywo steel, plastic сталь, пластмасса

Nóżka BD-100 z regulacją  
Adjustable leg BD-100  
Ножка BD-100 с регулировкой



	  H mm		
NM-BD-100-01	100 + 10	chrom / chrome / хром	stal / steel / сталь
NM-BD-100-02		satyna / satin / сатин	
NM-BD-100-05		aluminium / aluminium / алюминий	
NM-BD-100-06		stal szcztokowana / brushed steel / шлифованная сталь	



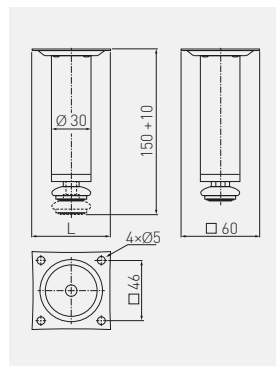

Nóżka BD-150 z regulacją  
Adjustable leg BD-150  
Ножка BD-150 с регулировкой

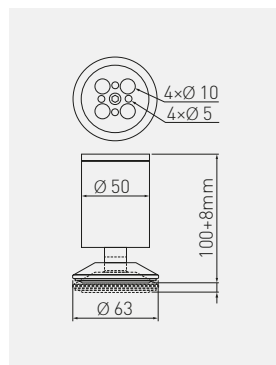

	  H mm		
NM-BD-150-01	150 + 10	chrom / chrome / хром	stal / steel / сталь
NM-BD-150-02		satyna / satin / сатин	

Nóżka BD-762 z regulacją  
Adjustable leg BD-762  
Ножка BD-762 с регулировкой



	 mm		
NM-BD-762-01	100 + 8	chrom / chrome / хром	ZnAl, stal / ZnAl, steel / ZnAl, сталь
NM-BD-762-05		aluminium / aluminium / алюминий	

Nóżka BD-867  
Leg BD-867  
Ножка BD-867

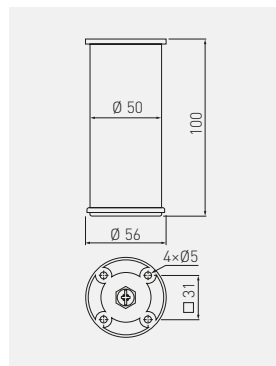

	 mm		
NM-BD867-100	100	aluminium / aluminium / алюминий	aluminium / aluminium / алюминий

Nóżka BD-868  
Leg BD-868  
Ножка BD-868

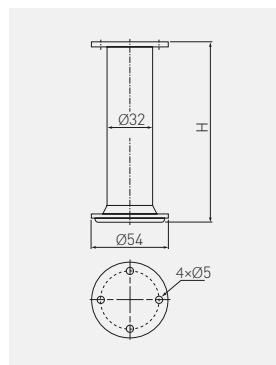

NM-BD868-100	100	aluminium / aluminium / алюминий	aluminium / aluminium / алюминий
NM-BD868-150	150		

Nóżka BD-869  
Leg BD-869  
Ножка BD-869

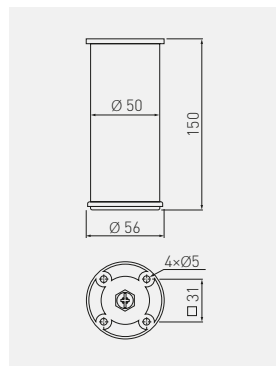





NM-BD869-150	150	aluminium / aluminium / алюминий	aluminium / aluminium / алюминий
--------------	-----	----------------------------------	----------------------------------

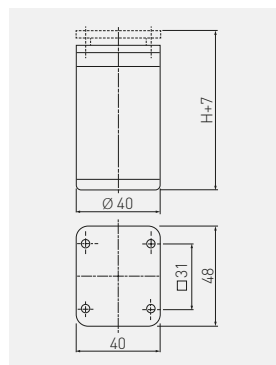





Nóżka DAP-77 z regulacją  
Adjustable leg DAP-77  
Ножка DAP-77 с регулировкой высоты

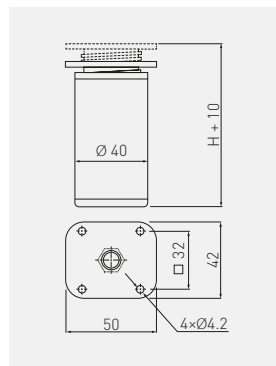

	 H mm		
NM-DAP77-60	60 + 7	aluminium / aluminium / алюминий	aluminium, tworzywo aluminium, plastic алюминий, пластмасса
NM-DAP77-100	100 + 7		
NM-DAP77-150	150 + 7		

Nóżka NAC z regulacją\*  
Adjustable leg NAC\*  
Ножка NAC с регулировкой высоты\*





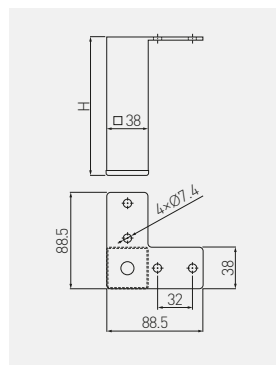

	 H mm		
NM-NAC-27651-06	60 + 10	chrom chrome хром	aluminium, tworzywo aluminium, plastic алюминий, пластмасса
NM-NAC-27651-10	100 + 10		
NM-NAC-27651-15	150 + 10		

\* Dostępny na zamówienie / Available only for individual order / Доступен под заказ

Nóżka B-104  
Leg B-104  
Ножка B-104



	 H mm		
NM-B104-100-01	100	chrom / chrome / хром	stal / steel / сталь
NM-B104-150-01	150		
NM-B104-200-01	200		

Nóżka SQ-40 z regulacją  
Adjustable leg SQ-40  
Ножка SQ-40 с регулировкой высоты

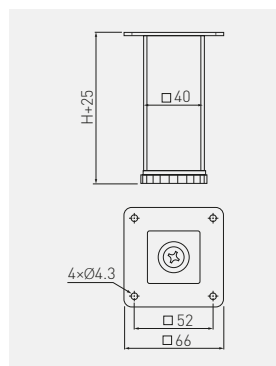

	 H mm		
NM-SQ40ADJ-060	60 + 25	chrom / chrome / хром	stal / steel / сталь
NM-SQ40ADJ-100	100 + 25		

Nóżka SQA z regulacją  
Adjustable leg SQA  
Ножка SQA с регулировкой высоты

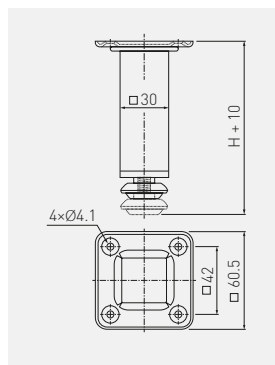

	 mm		
NM-SQA100-01	100 + 10	chrom / chrome / хром	stal / steel / сталь
NM-SQA150-01*	150 + 10		

\*Dostępny na zamówienie / Available only for individual order / Доступен под заказ

Nóżka BD-727  
Leg BD-727  
Ножка BD-727

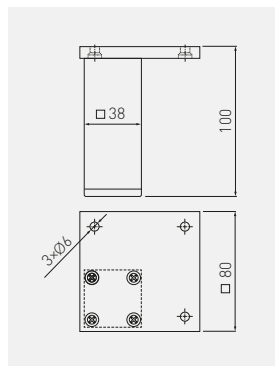

	 mm		
NM-BD727-100	100	aluminium / aluminium / алюминий	aluminium / aluminium / алюминий

Nóżka BD-739  
Leg BD-739  
Ножка BD-739

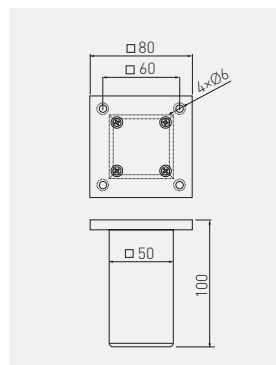

NM-BD-739-05	100	aluminium / aluminium / алюминий	aluminium / aluminium / алюминий
--------------	-----	----------------------------------	----------------------------------

Nóżka DAK-27 z regulacją  
Adjustable leg DAK-27  
Ножка DAK-27 с регулировкой высоты

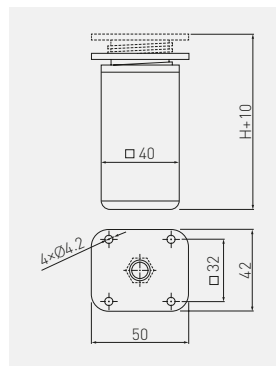

NM-DAK27-060	60 + 10	aluminium aluminium алюминий	aluminium, tworzywo aluminium, plastic алюминий, пластмасса
NM-DAK27-080	80 + 10		
NM-DAK27-100	100 + 10		
NM-DAK27-120	120 + 10		
NM-DAK27-150	150 + 10		

Nóżka NACK z regulacją\*  
Adjustable leg NACK\*  
Ножка NACK с регулировкой высоты\*

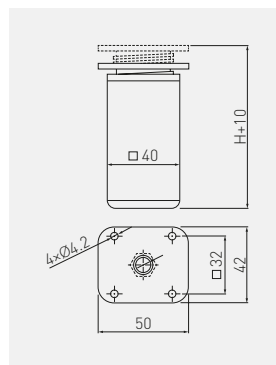

	  H mm		
NM-NACK27651-06	60 + 10	chrom chrome хром	tworzywo, aluminium plastic, aluminium пластмасса, алюминий
NM-NACK27651-10	100 + 10		

\* Dostępny na zamówienie / Available only for individual order / Доступен под заказ

Nóżka BD-01  
Leg BD-01  
Ножка BD-01

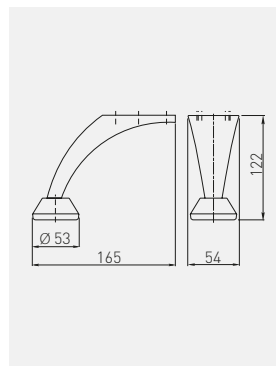

	  H mm		
NM-BD-001-M1B	122	chrom / chrome / хром	stal / steel / сталь

Nóżka BD-712  
Leg BD-712  
Ножка BD-712

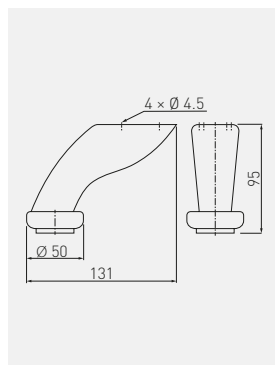

NM-BD-712-M1	95	chrom / chrome / хром	stal / steel / сталь
--------------	----	-----------------------	----------------------

\*Dostępny na zamówienie / Available only for individual order / Доступен под заказ

Nóżka STGC 50  
Leg STGC 50  
Ножка STGC 50

NEW

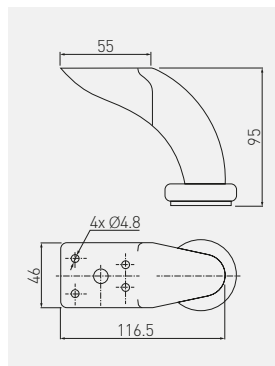



NM-STGC50-95-01	95	chrom / chrome / хром	stal / steel / сталь
-----------------	----	-----------------------	----------------------

Nóżka STGY 135  
Leg STGY 135  
Ножка STGY 135

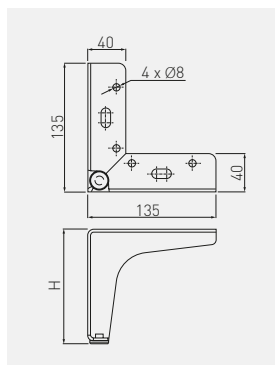
NEW



		 H mm		
NM-STGY135-100-01		100	chrom / chrome / хром	stal + tworzywo steel + plastic сталь + пластик
NM-STGY135-130-01		130		
NM-STGY135-150-01		150		

Nóżka STGY-135  
Leg STGY-135  
Ножка STGY-135

NEW

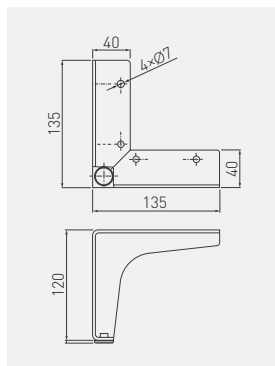

		 H mm		
NM-STGY135-120-01		120	chrom / chrome / хром	stal / steel / сталь

Nóżka STOMP  
Leg STOMP  
Ножка STOMP

NEW

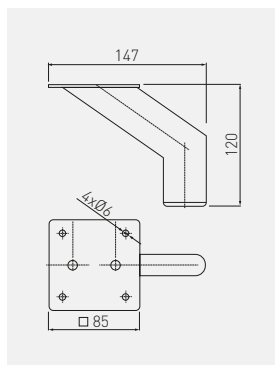

NM-STOMP-120-20

120

czarny / black / чёрный

stal / steel / сталь

Nóżka STOMP  
Leg STOMP  
Ножка STOMP

NEW

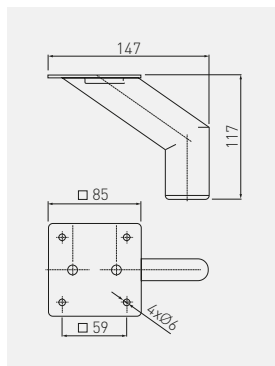

NM-STOMP-120-01

117

chrom / chrome / хром

stal / steel / сталь



Nóżka STPL 135  
Leg STPL 135  
Ножка STPL 135

NEW

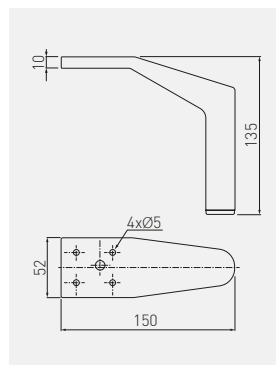

NM-STPL-135-01

135

chrom / chrome / хром

stal / steel / сталь

Nóżka MDN-D4  
Leg MDN-D4  
Ножка MDN-D4

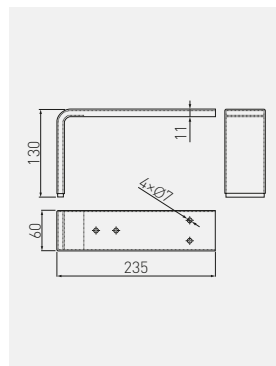

NM-MDN-D4-01

130

chrom / chrome / хром

stal / steel / сталь

Nóżka XH-30  
Leg XH-30  
Ножка XH-30

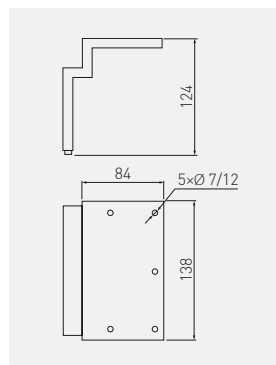

NM-XH3065-05*	124	aluminium / aluminium / алюминий	aluminium / aluminium / алюминий
---------------	-----	----------------------------------	----------------------------------

\* Dostępny na zamówienie / Available only for individual order / Доступен под заказ

Nóżka XH-82  
Leg XH-82  
Ножка XH-82

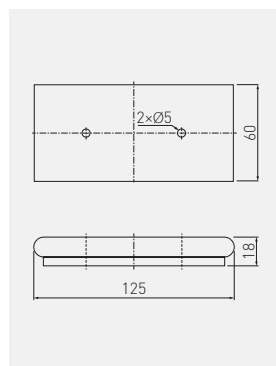

NM-XH8273-01	18	chrom / chrome / хром	ZnAl
--------------	----	-----------------------	------

Nózka MDN-926  
 Leg MDN-926  
 Ножка MDN-926

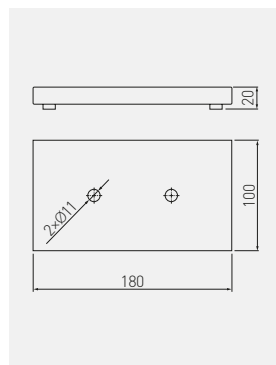

NM-MDN926-01

20

chrom / chrome / хром

stal / steel / сталь

Nózka MDN-927  
 Leg MDN-927  
 Ножка MDN-927

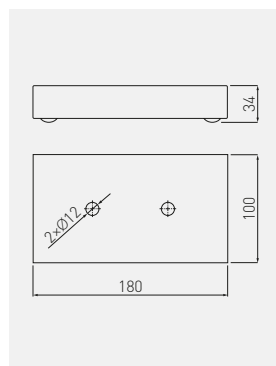

NM-MDN927-01

34

chrom / chrome / хром

stal / steel / сталь

Nózka MDN-941  
Leg MDN-941  
Ножка MDN-941

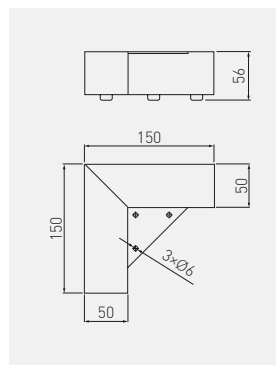

NM-MDN941-01

56

chrom / chrome / хром

stal / steel / сталь

Nózka STSL  
Leg STSL  
Ножка STSL

NEW

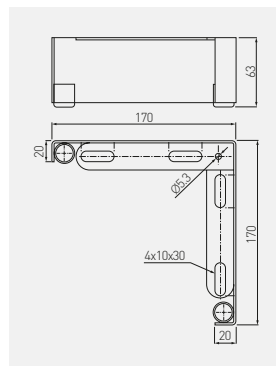

NM-STSL-170-60-01

63

chrom / chrome / хром

stal / steel / сталь

Ślizgacz WPJ z regulacją  
Adjustable furniture slider WPJ  
Опора WPJ с регулировкой

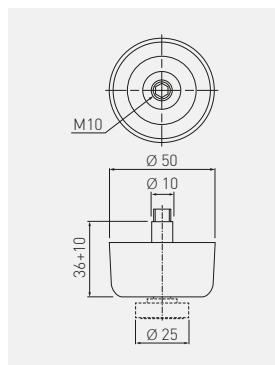

NM-WPJ22-D20



36 + 10



czarny / black / чёрный



tworzywo / plastic / пластмасса

Ślizgacz SLZ pojedynczy  
Furniture slider SLZ single  
Опора SLZ одинарная

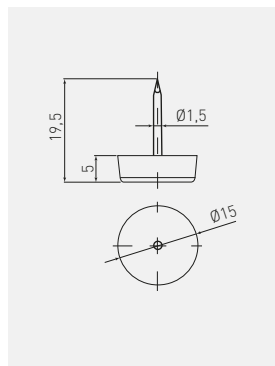

BP-SLZIGW-10



czarny / black / чёрный



tworzywo / plastic / пластмасса

Ślizgacz SLZ podwójny  
Furniture slider SLZ double  
Опора SLZ двойная

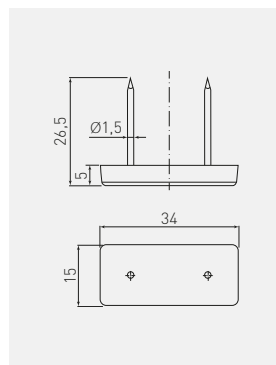

		
BP-SLZIGW-21	czarny black чёрный	tworzywo plastic пластмасса

Stopka M6 regulowana  
Foot M6 adjustable  
Ножка M6 с регулировкой

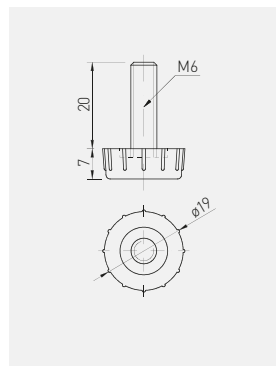

		
NM-STOPKA-M6	ocynk galvanized гальваника	stal, tworzywo steel, plastic сталь, пластмасса

Stopka M6 regulowana sześciokątna  
 Foot M6 adjustable hexagonal  
 Ножка М6 с регулировкой (шестигранная)

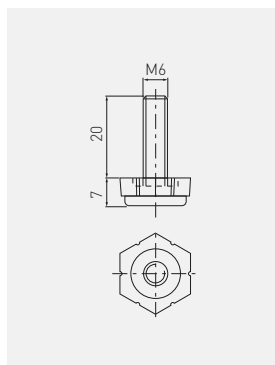

		
NM-STOPKSZESTK-M6	ocynk galvanized гальваника	stal, tworzywo steel, plastic сталь, пластмасса

Mufa M6  
 Socket M6  
 Муфта М6







NM-MUFAWB-00

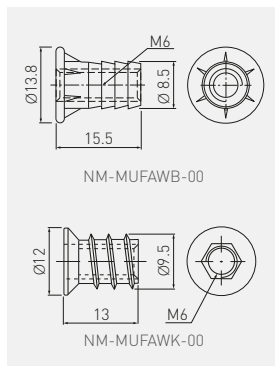

NM-MUFAWK-00



			
NM-MUFAWB-00	wbijana screw-in sleeve врезная	srebrny silver серебряный	ZnAl
NM-MUFAWK-00	wkręcana screwed для вкручивания		

Nóżka DPD z regulacją  
Adjustable leg DPD  
Ножка DPD с регулировкой

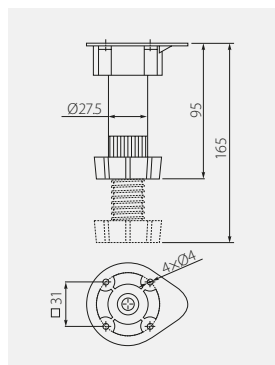

NM-DPD20-100	95 - 165	60	czarny / black / чёрный	tworzywo / plastic / пластмасса
--------------	----------	----	-------------------------	---------------------------------

Klip do nóżki DPD  
Plinth clip DPD  
Клипса к ножке DPD

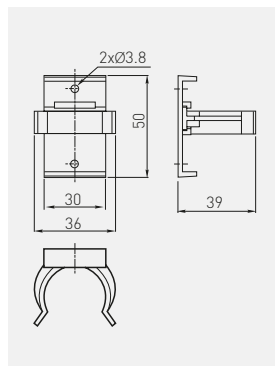

NM-KL-DPL-20	czarny / black / чёрный	tworzywo / plastic / пластмасса
--------------	-------------------------	---------------------------------



Nóżka DPA  
Leg DPA  
Ножка DPA

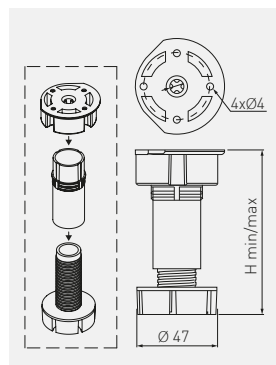

NM-DPA20-100	pakowane w karton packing in box картонная упаковка	87 - 120	100	czarny black чёрный	tworzywo plastic пластмасса
NM-DPA20-150		137 - 170			
NM-DPA20-100W	pakowane w worek packing in plastic bag полиэтиленовый пакет	87 - 120			
NM-DPA20-150W		137 - 170			

Klip do nóżki DPA  
Plinth clip DPA  
Клипса к ножке DPA

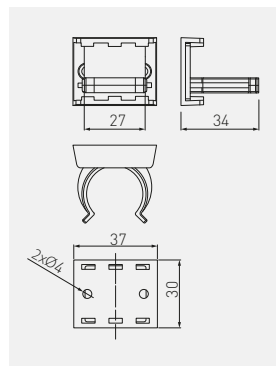

NM-KL-DPA-20	czarny / black / чёрный	tworzywo / plastic / пластмасса
--------------	-------------------------	---------------------------------

Nóżka ML-50 z regulacją  
Adjustable leg ML-50  
Ножка ML-50 с регулировкой

NEW

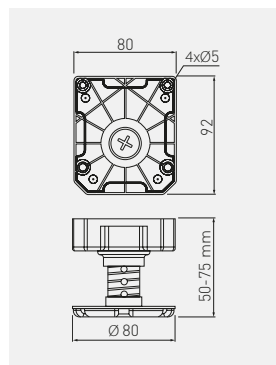

NM-ML-50-75

50-75

450

czarny / black / чёрный

tworzywo / plastic / пластмасса

Nóżka ML-65 z regulacją  
Adjustable leg ML-65  
Ножка ML-65 с регулировкой

NEW

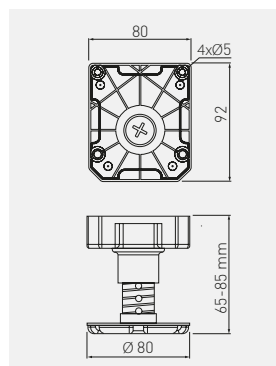

NM-ML-65-85

65-85

450

czarny / black / чёрный

tworzywo / plastic / пластмасса

Nóżka ML-85 z regulacją  
Adjustable leg ML-85  
Ножка ML-85 с регулировкой

NEW

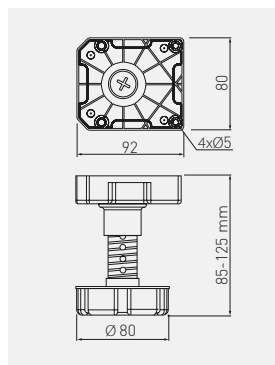

NM-ML-85-125



85-125



450



czarny / black / чёрный



tworzywo / plastic / пластмасса

Nóżka ML-95 z regulacją  
Adjustable leg ML-95  
Ножка ML-95 с регулировкой

NEW

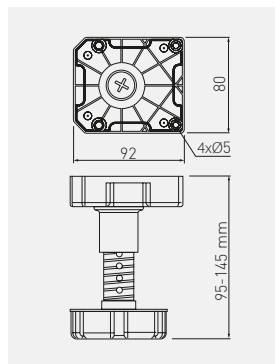

NM-ML-95-145



95-145



450



czarny / black / чёрный



tworzywo / plastic / пластмасса

Nóżka ML-125 z regulacją  
Adjustable leg ML-125  
Ножка ML-125 с регулировкой

NEW

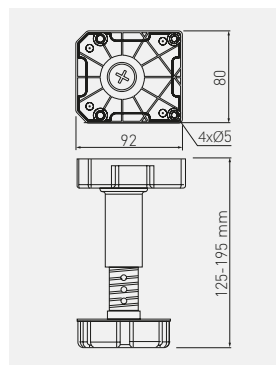

NM-ML-125-195

125-195

450

czarny / black / чёрный

tworzywo / plastic / пластмасса

Klip do nóżek ML  
Clip for ML legs  
Клипса к ножке ML

NEW

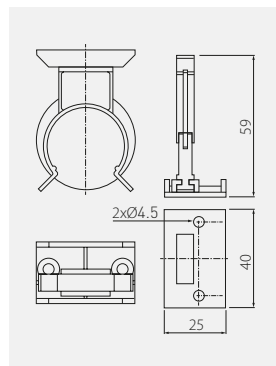

NM-ML-KL

czarny / black / чёрный

tworzywo / plastic / пластмасса

Mechanizm zapadkowy zagłówek sofy  
Ratchet mechanism of the sofa's bolster  
Механизм трансформации подголовника

NEW

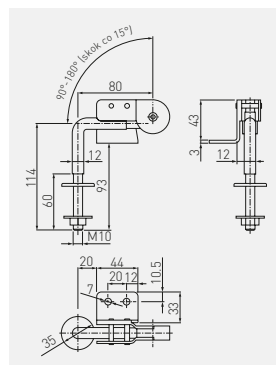

AMS-MPST001-OC

kąt otwarcia 90-180  
opening angle 90-180  
угол открытия 90-180

stal  
steel  
сталь

Mechanizm zapadkowy zagłówek sofy z regulacją  
Ratchet mechanism of the sofa's bolster with adjustment  
Механизм открытия подголовника с регулятором

NEW

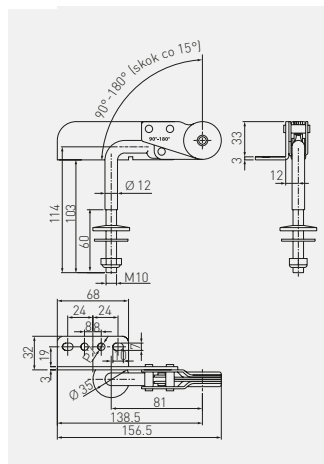

AMS-MPST002-OC

kąt otwarcia 90-180  
opening angle 90-180  
угол открытия 90-180

stal  
steel  
сталь



Noga A6 z regulacją  
Adjustable leg A6  
Опора A6 с регулировкой

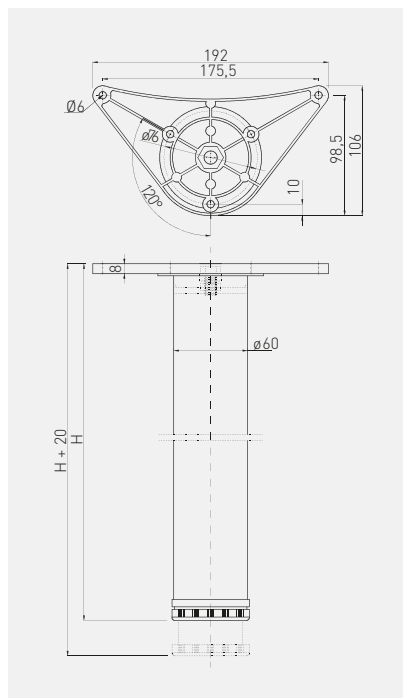

	  H mm		
NM-A60710-01	710 + 30	chrom / chrome / хром	
NM-A60710-02		satyna / satin / сатин	
NM-A60710-05		aluminium / aluminium / алюминий	
NM-A60710-10*		biały / white / белый	
NM-A60710-20		czarny / black / чёрный	
NM-A60710-80		srebrny / silver / серебристый	
NM-A60820-01	820 + 30	chrom / chrome / хром	
NM-A60820-02		satyna / satin / сатин	
NM-A60820-05		aluminium / aluminium / алюминий	
NM-A60820-10*		biały / white / белый	
NM-A61100-01	1100 + 30	chrom / chrome / хром	
NM-A61100-02		satyna / satin / сатин	
NM-A61100-05		aluminium / aluminium / алюминий	
NM-A61100-06		stal szczerkowana / brushed steel / шлифованная сталь	
NM-A61100-10*		biały / white / белый	
NM-A61100-20*		czarny / black / чёрный	

\*Dostępny na zamówienie / Available only for individual order / Доступен под заказ

Noga G6 z regulacją  
Adjustable leg G6  
Опора G6 с регулировкой

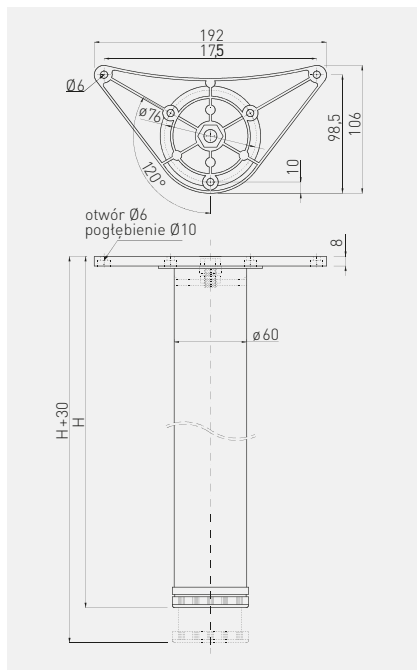

		 H mm		
NM-G60710-01		710 + 30	chrom / chrome / хром	stal, aluminium steel, aluminium сталь, алюминий
NM-G60710-02			satyna / satin / сатин	
NM-G60710-03			mosiądz / brass / латунь	
NM-G60710-05			aluminium / aluminium / алюминий	
NM-G60710-06			stal szczotkowana / brushed steel / шлифованная сталь	
NM-G60710-20			czarny / black / чёрный	
NM-G60710-80		srebrny / silver / серебристый		
NM-G60820-01		820 + 30	chrom / chrome / хром	
NM-G60820-05			aluminium / aluminium / алюминий	
NM-G60820-06			stal szczotkowana / brushed steel / шлифованная сталь	
NM-G60820-20			czarny / black / чёрный	
NM-G61100-01		1100 + 30	chrom / chrome / хром	
NM-G61100-05			aluminium / aluminium / алюминий	
NM-G61100-20			czarny / black / чёрный	

\*Na zamówienie klienta dostępna w kolorze białym / For special orders available in white color / Под заказ доступна в белом цвете



Noga S6 z regulacją  
Adjustable leg S6  
Опора S6 с регулировкой

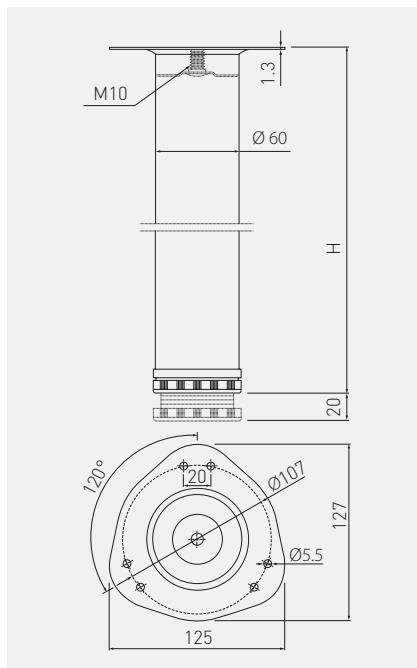

NM-S60710-01	710	chrom / chrome / хром	stal / steel / сталь
NM-S60710-02		satyna / satin / сатин	
NM-S60710-05		aluminium / aluminium / алюминий	
NM-S60820-01	820	chrom / chrome / хром	
NM-S60820-02		satyna / satin / сатин	

Noga F-50 składana\*  
 Leg F-50 foldable  
 Складная опора F-50

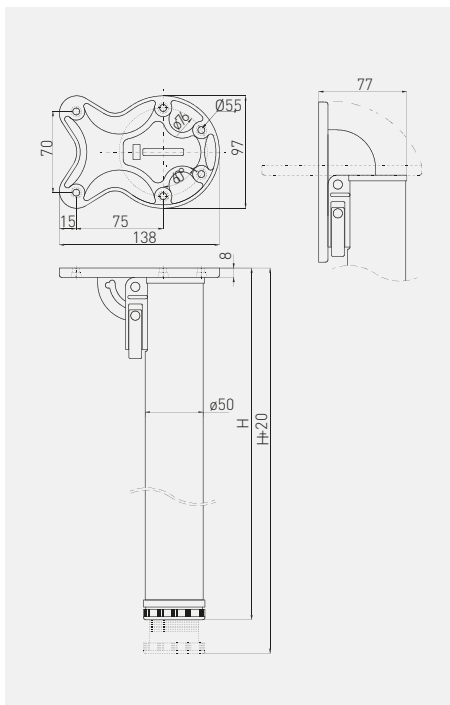

NM-F50710-01	710	chrom / chrome / хром	ZnAl, stal, ABS ZnAl, steel, ABS ZnAl, сталь, ABS
NM-F50710-06		stal szczotkowana / brushed steel / шлифованная сталь	
NM-F50710-10		biały / white / белый	
NM-F50710-20		czarny / black / чёрный	
NM-F50870-01	870	chrom / chrome / хром	
NM-F50870-06		stal szczotkowana / brushed steel / шлифованная сталь	
NM-F50870-10		biały / white / белый	
NM-F50870-20		czarny / black / чёрный	

\*Dostępny na zamówienie / Available only for individual order / Доступен под заказ

Noga kwadratowa z regulacją  
 Square furniture leg  
 Мебельная опора с регулировкой

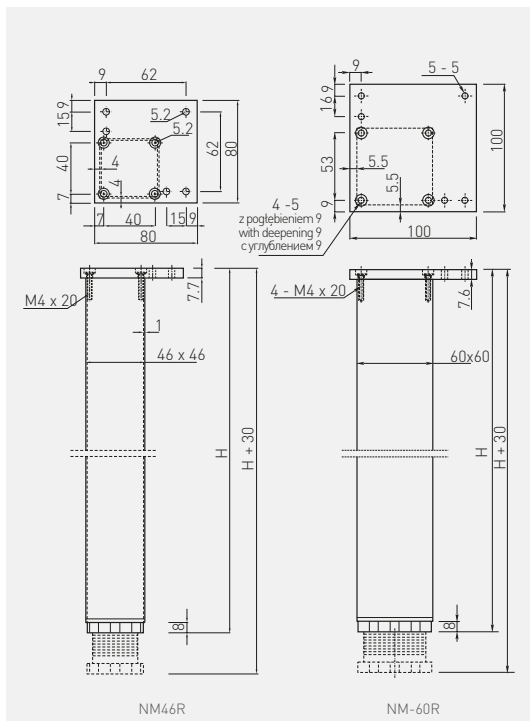
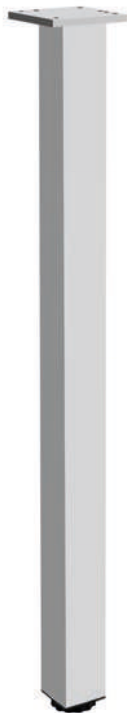





		 H mm		
NM-46R710-05		710 + 30	aluminium / aluminium / алюминий	aluminium aluminium алюминий
NM-46R820-05		820 + 30		
NM-60R710-05		710 + 30		
NM-60R820-05		820 + 30		
NM-60R710-06*		710 + 30	stal szczotkowana / brushed steel / шлифованная сталь	
NM-60R710-20*		710 + 30	czarny / black / чёрный	

\* Dostępna na zamówienie / Available only for individual order / Доступен под заказ

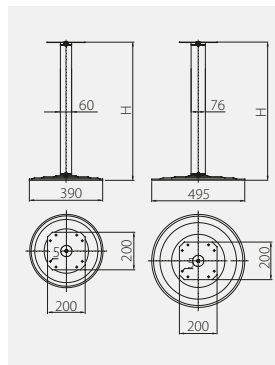
\* Na indywidualne zamówienie dostępna w wysokości 1100 mm / For special orders 1100 mm height also available  
 Под заказ доступна также с высотой 1100 мм

Noga barowa  
Bar leg  
Барная опора



	 H mm	 Ø mm		
NM-380X730-01	735	60	chrom / chrome / хром	stal / steel / сталь
NM-480X730-01	735	76		



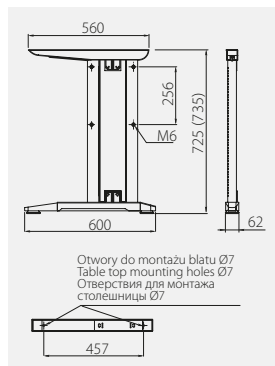
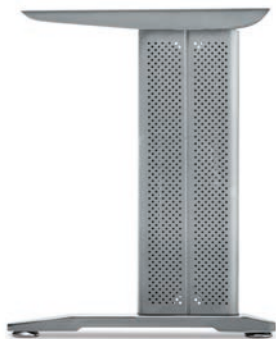

Stelaż biurkowy  
Metal frames for desk  
Металлический каркас для стола

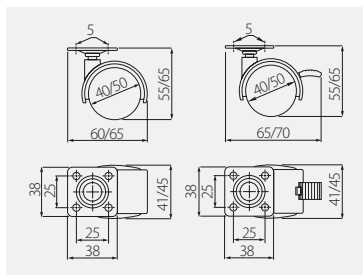

	 H mm		
SB-A60X72-80	725 (735)	srebrny / silver/ серебристый	stal / steel / сталь





Rolka KM-D20  
 Furniture caster KM-D20  
 Колёсики KM-D20

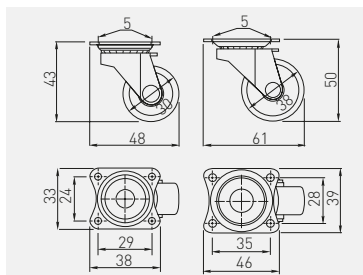

					
KM-00-40-D20	bez hamulca without break без стопора	40	18	czarny black черный	plastik plastic пластмасса
KM-00-50-D20		50	22		
KM-0H-40-D20	z hamulcem with break со стопором	40	18		
KM-0H-50-D20		50	22		

Rolka KM 15 plastikowa  
 Furniture caster KM 15 plastic  
 Пластиковые Колёсики KM 15



				
KM-015030-10	30	13,5	biały / white / белый	plastik plastic пластмасса
KM-015030-20			czarny / black / черный	
KM-015038-10	38	16	biały / white / белый	

Rolka KM 15 gumowa  
 Rubber furniture caster KM 15  
 Резиновые колёсики KM 15

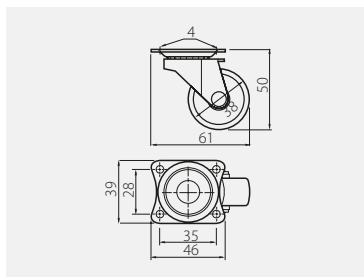

KM-015038-GM	38	16	czarny / black / черный	guma / rubber / резина



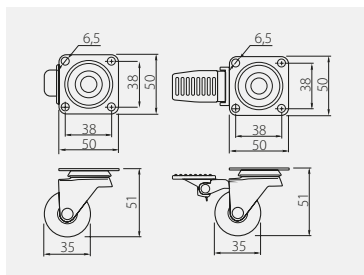

Rolka KMA 35  
 Furniture caster KMA 35  
 Колёсики KMA 35

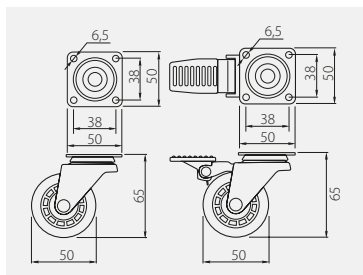

KM-A035MM-00	bez hamulca without break без стопора	35	25	przeźroczysty / transparent / прозрачный	PC / PU
KM-A035MM-30				brązowy / brown / коричневый	
KM-AH35MM-00	z hamulcem with break со стопором			przeźroczysty / transparent / прозрачный	
KM-AH35MM-30	brązowy / brown / коричневый				





Rolka KMA 50  
Furniture caster KMA 50  
Колесики KMA 50

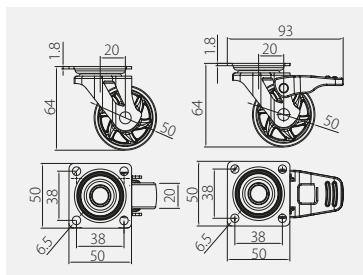

		 mm	 kg		
KM-A050MM-00	bez hamulca without break	50	35	przeźroczysty / transparent / прозрачный	PC / PU
KM-A050MM-30	bez stopopa			brąz / brown / коричневый	
KM-AH50MM-00	z hamulcem with break			przeźroczysty / transparent / прозрачный	
KM-AH50MM-30	co stopopom			brąz / brown / коричневый	





Rolka SHIFT 50  
Furniture caster SHIFT 50  
Колесики SHIFT 50

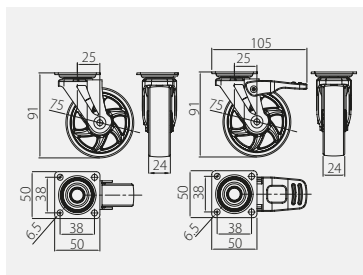

		 mm	 kg		
KM-B050MM-00	bez hamulca without break	50	30	przeźroczysty / transparent / прозрачный	PC / PU
KM-B050MM-30	bez stopopa			brąz / brown / коричневый	
KM-BH50MM-00	z hamulcem with break			przeźroczysty / transparent / прозрачный	
KM-BH50MM-30	co stopopom			brąz / brown / коричневый	





Rolka SHIFT 75  
 Furniture caster SHIFT 75  
 Колесики SHIFT 75

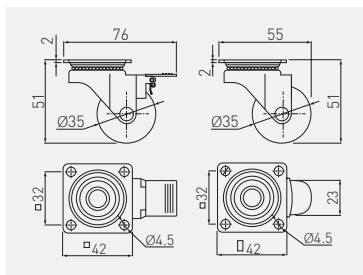

		 mm	 kg		
KM-B075MM-00	bez hamulca without break без стопора	75	40	przeźroczysty / transparent / прозрачный	PC / PU
KM-B075MM-30	z hamulcem with break со стопором			brąz / brown / коричневый	
KM-BH75MM-00	bez hamulca without break без стопора	przeźroczysty / transparent / прозрачный			
KM-BH75MM-30	z hamulcem with break со стопором	brąz / brown / коричневый			

Rolka BRAZYLIA 35  
 Caster BRAZYLIA 35  
 Колесики BRAZYLIA 35



		 mm	 kg		
KM-RD-35-SF	bez hamulca without break без стопора	35	30	przeźroczysty / transparent / прозрачный	PC, PU
KM-RD-35-CF	z hamulcem with break со стопором				



Rolka BRAZYLIA 50  
 Caster BRAZYLIA 50  
 Колесики BRAZYLIA 50

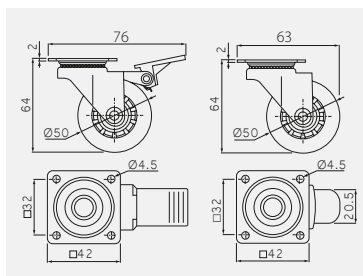

		 mm	 kg		
KM-RD-50-SF	bez hamulca without break без стопора	50	40	przeźroczysty / transparent / прозрачный	PC, PU
KM-RD-50-CF	z hamulcem with break со стопором	50	40		

Rolka BRAZYLIA 75  
 Caster BRAZYLIA 75  
 Колесики BRAZYLIA 75

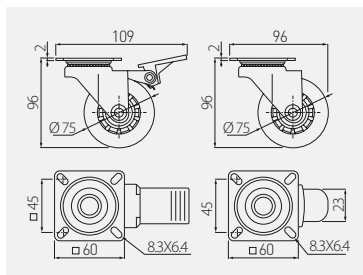

		 mm	 kg		
KM-RD-75-SF	bez hamulca without break без стопора	75	64	przeźroczysty / transparent / прозрачный	PC, PU
KM-RD-75-CF	z hamulcem with break со стопором	75	64		

Zamek K-138  
Lock K-138  
Замок K-138

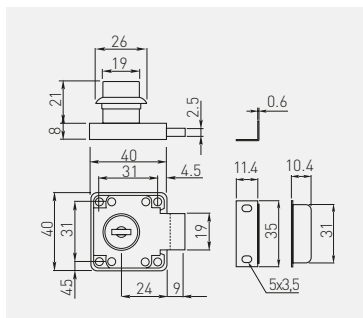

ZZ-KM-138-01



chrom / chrome / хром



ZnAl, stal / ZnAl, steel / ZnAl, сталь

Zamek Z-138 z kluczem łamanym  
Lock Z-138 with folding key  
Замок Z-138 со складным ключом

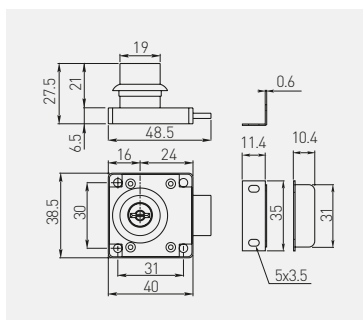

ZZ-ZN-138-01



chrom / chrome / хром



ZnAl, stal / ZnAl, steel / ZnAl, сталь

Zamek C-138 z kluczem cyfrowym

Lock C-138 with key

Замок C-138 с цифровым ключом

Kompatybilny z kluczem MASTER

Compatible with MASTER key

Подходит для ключа MASTER

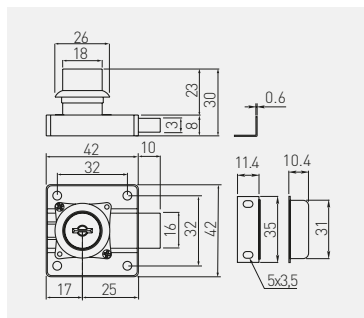

ZZ-CF-138-01



chrom / chrome / хром



ZnAl, stal / ZnAl, steel / ZnAl, сталь

Klucz MASTER do zamka C-138

MASTER key for C-138 lock

Ключ MASTER к замку C-138



ZZ-KLMASTER



chrom / chrome / хром



ZnAl, stal / ZnAl, steel / ZnAl, сталь

Zamek Z-338 zatrzaskowy  
 Square lock Z-338  
 Замок с защёлкой Z-338

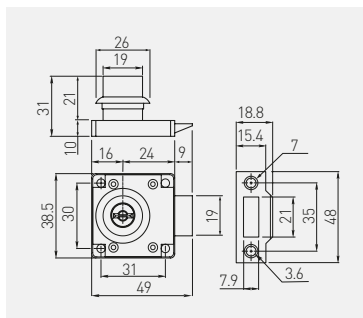

ZZ-ZN-338-01



chrom / chrome / хром



ZnAl, stal / ZnAl, steel / ZnAl, сталь

Zamek B-105 bolcowy  
 Pin lock B-105  
 Замок кнопочный B-105

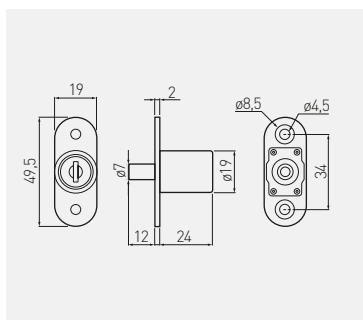

ZZ-B0-105-01







chrom / chrome / хром

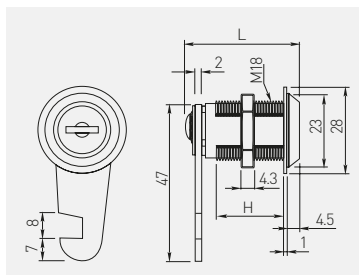

ZnAl, stal / ZnAl, steel / ZnAl, сталь



Zamek Z-103 skrzynkowy  
 Box lock Z-103  
 Замок Z-103

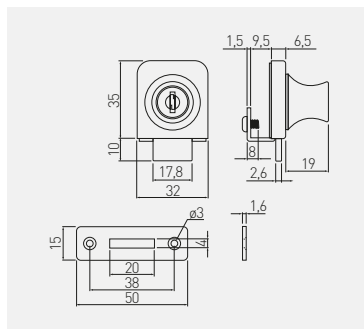

		 L mm	 H mm		
ZZ-16-103-01		27 mm	12	chrom / chrome / хром	ZnAl, stal / ZnAl, steel / ZnAl, сталь
ZZ-20-103-01		30 mm	16,5		
ZZ-30-103-01		40 mm	26,5		

Zamek S-407 do szyb  
 Glass door lock S-407  
 Замок для стеклянной распашной двери S-407



			
ZZ-SZ-407-01		chrom / chrome / хром	ZnAl, stal / ZnAl, steel / ZnAl, сталь

Zamek S-408 do szyb  
Glass door lock S-408  
Замок S-408 для стеклянных дверей

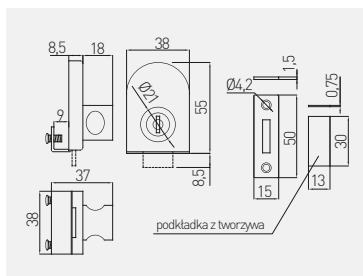

Zastosowanie do szkła 4 - 8 mm  
For 4 - 8 mm glass  
Толщина стекла 4-8 мм



ZZ-SZ-408-01

chrom / chrome / хром

ZnAl, stal / ZnAl, steel / ZnAl, сталь

Zamek S-409 do szyb  
Glass door lock S-409  
Замок S-409 для стеклянных дверей

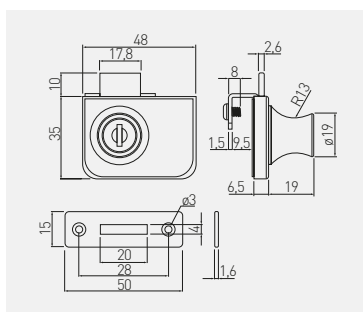

Zastosowanie do szkła 4 - 8 mm  
For 4 - 8 mm glass  
Толщина стекла 4-8 мм



ZZ-SZ-409-01

chrom / chrome / хром

ZnAl, stal / ZnAl, steel / ZnAl, сталь

Zamek M-201  
Lock M-201  
Замок M-201

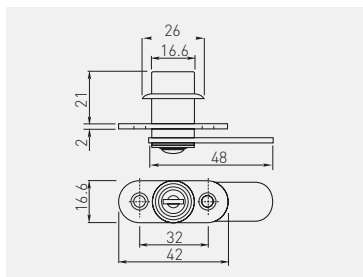

ZZ-M0-201-01

chrom / chrome / хром

ZnAl, stal / ZnAl, steel / ZnAl, сталь

Zamek Z-202 żaluzjowy  
Double hook lock Z-202  
Замок Z-202 жалюзийный

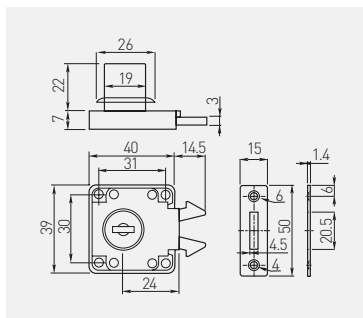

ZZ-Z0-202-01

chrom / chrome / хром

ZnAl, stal / ZnAl, steel / ZnAl, сталь

Zamek G-328 grzbietowy  
Sliding glass door lock G-328  
Замок G-328 внутрений

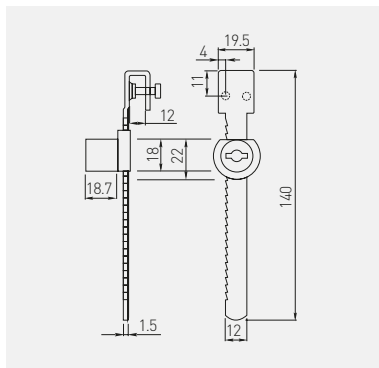

Zastosowanie do szkła 4 - 8 mm  
For 4 - 8 mm glass  
Толщина стекла 4-8 мм



ZZ-G0-328-01

chrom / chrome / хром

ZnAl, stal / ZnAl, steel / ZnAl, сталь

Zamek baskwilowy  
Espagnolette lock  
Замок шпингалетный

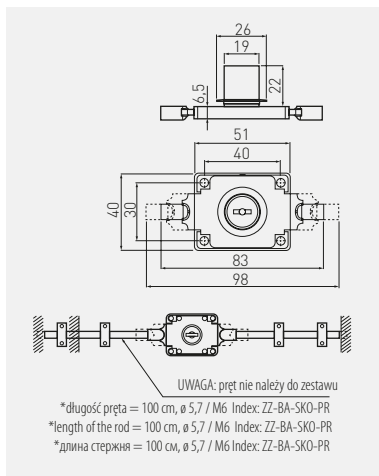

ZZ-BA-SKO-01

chrom / chrome / хром

ZnAl, stal / ZnAl, steel / ZnAl, сталь



Zamek C-288 centralny  
Cabinet drawer lock C-288  
Замок центральный боковой C-288

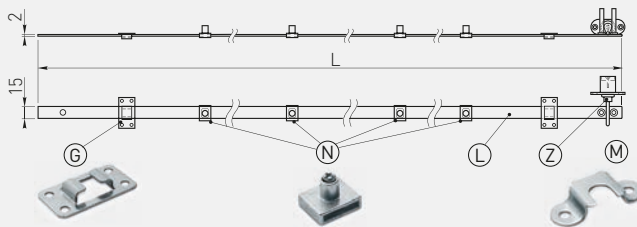

Skład zestawu / Set includes / Состав набора:

- Ⓒ Mocowanie listwy / slat fixing / крепление планки
- Ⓓ Blokady szuflady / drawer locking mechanism / блокада ящика
- Ⓕ Listwa zamka / lock slat / планка замка
- Ⓖ Zamek / lock / замок
- Ⓜ Zaczep / hook / зацепка

model	C5	C6	C8	C1
L	500	600	800	1200
N	3	3	4	4
M	3	3	4	4
G	2	2	3	3

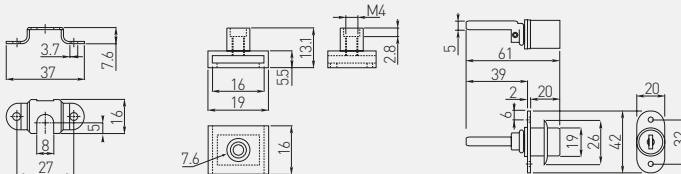

		 mm		
	ZZ-C5-288-01	500	chrom / chrome / хром	ZnAl, stal / ZnAl, steel / ZnAl, сталь
	ZZ-C6-288-01	600		
	ZZ-C8-288-01	800		
	ZZ-C1-288-01	1200		

**SYSTEMY PRZESUWNE  
SLIDING DOOR SYSTEMS  
РАЗДВИЖНЫЕ СИСТЕМЫ**

Dolny układ jezdny  
Bottom-running systems  
Нижняя ходовая система

382 – 406

Górny układ jezdny  
Top-running systems  
Верхняя ходовая система



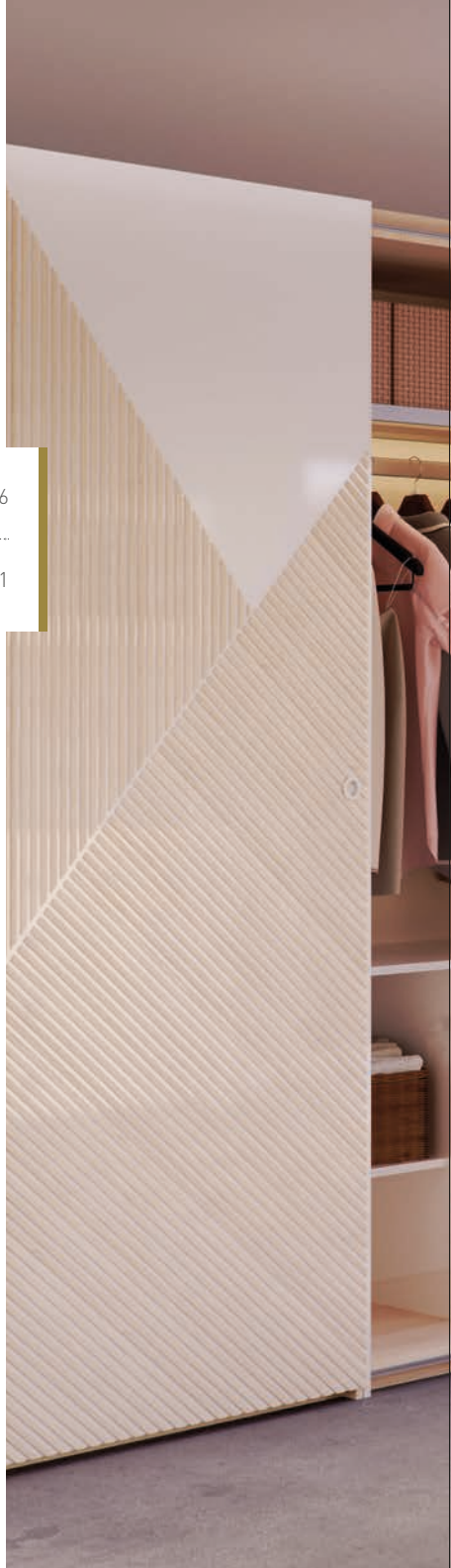

407 – 411



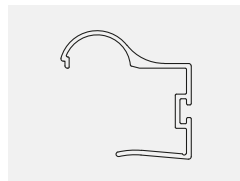

Rączka ERGO  
Handle ERGO  
Ручка ERGO



	 L mm		
A-R18ERG-270-05	2700	aluminium / aluminium / алюминий	aluminium aluminium алюминий
A-R18ERG-270-90		szampan / champagne / шампань	



Rączka ERGO 16  
Handle ERGO 16  
Ручка ERGO 16



NEW

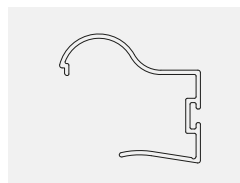





	 L mm		
A-R16ERG-270-50	2700	aluminium / aluminium / алюминий	aluminium / aluminium / алюминий

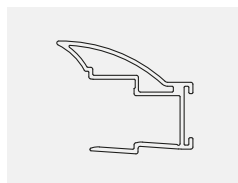

Rączka NOVO 2  
Handle NOVO 2  
Ручка NOVO 2



	 L mm		
A-RNOV2-270-05	2700	aluminium / aluminium / алюминий	aluminium aluminium алюминий
A-RNOV2-270-10		biały / white / белый	
A-RNOV2-270-90		szampan / champagne / шампань	



+



Rączka NOVO S  
Handle NOVO S  
Ручка NOVO S

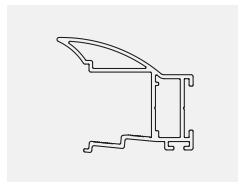



	 L mm		
A-R18NOVS-270-05	2700	aluminium / aluminium / алюминий	aluminium aluminium алюминий
A-R18NOVS-270-10		biały / white / белый	
A-R18NOVS-270-90		szampan / champagne / шампань	

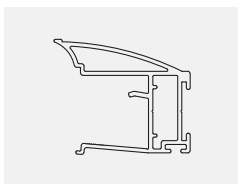

Rączka CARO  
Handle CARO  
Ручка CARO







	 L mm		
A-R18CARO-270-05	2700	aluminium / aluminium / алюминий	aluminium aluminium алюминий
A-R18CARO-270-90		szampan / champagne / шампань	

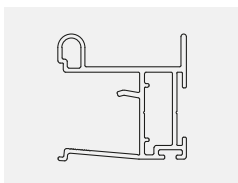

Rączka VISTA  
Handle VISTA  
Ручка VISTA





	 L mm		
A-R18VIS-270-05	2700	aluminium / aluminium / алюминий	aluminium aluminium алюминий
A-R18VIS-270-90		szampan / champagne / шампань	

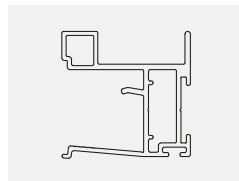

Rączka NERO  
Handle NERO  
Ручка NERO







	 L mm		
A-R18NERO-270-05	2700	aluminium / aluminium / алюминий	aluminium aluminium алюминий
A-R18NERO-270-10		biały / white / белый	
A-R18NERO-270-90		szampan / champagne / шампань	

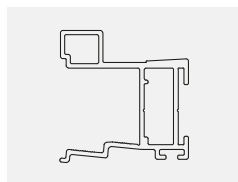

Rączka COTE  
Handle COTE  
Ручка COTE







	 L mm		
A-R18COTE-270-05	2700	aluminium / aluminium / алюминий	aluminium aluminium алюминий
A-R18COTE-270-90		szampan / champagne / шампань	

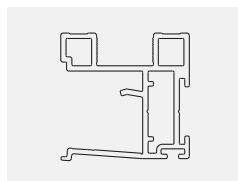

Rączka LOCA  
Handle LOCA  
Ручка LOCA







	 L mm		
A-R18LOCA-305-05	3050	aluminium / aluminium / алюминий	aluminium aluminium алюминий
A-R18LOCA-305-90		szampan / champagne / шампань	

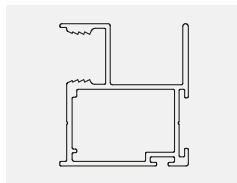

Rączka FLAT LINE  
Handle FLAT LINE  
Ручка FLAT LINE





	 L mm		
A-R10FL-270-05	2700	aluminium / aluminium / алюминий	aluminium aluminium алюминий
A-R10FL-270-10		biały / white / белый	
A-R10FL-270-90		szampan / champagne / шампань	

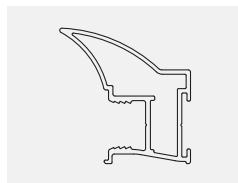

Rączka NOVO 10  
Handle NOVO 10  
Ручка NOVO 10



	 L mm		
A-R10NOV-270-05	2700	aluminium / aluminium / алюминий	aluminium aluminium алюминий
A-R10NOV-270-10		biały / white / белый	
A-R10NOV-270-90		szampan / champagne / шампань	



Rączka FORM  
Handle FORM  
Ручка FORM

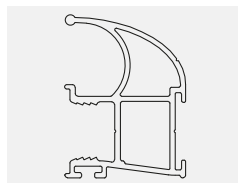





	 L mm		
A-R10FORM-270-05	2700	aluminium / aluminium / алюминий	aluminium aluminium алюминий
A-R10FORM-270-90		biały / white / белый	

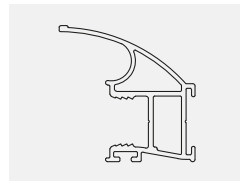

Rączka TRAF0  
Handle TRAF0  
Ручка TRAF0







	 mm		
A-R10TRAF0-270-05	2700	aluminium / aluminium / алюминий	aluminium aluminium алюминий
A-R10TRAF0-270-90		szampan / champagne / шампань	

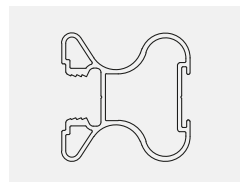

Rączka FALDA  
Handle FALDA  
Ручка FALDA



	 mm		
A-R10FALDA-270-05	2700	aluminium / aluminium / алюминий	aluminium aluminium алюминий
A-R10FALDA-270-90		szampan / champagne / шампань	



Rączka ARCO  
Handle ARCO  
Ручка ARCO

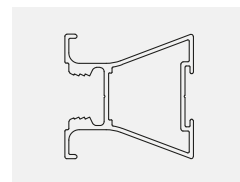



	 mm		
A-R10ARCO-270-05	2700	aluminium / aluminium / алюминий	aluminium aluminium алюминий
A-R10ARCO-270-90		szampan / champagne / шампань	



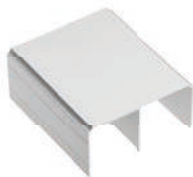

Tor górny  
Top track  
Верхняя направляющая



	 L mm		
A-TG-170-05	1700	aluminium / aluminium / алюминий	aluminium aluminium алюминий
A-TG-170-90		szampan / champagne / шампань	
A-TG-235-05	2350	aluminium / aluminium / алюминий	
A-TG-235-90		szampan / champagne / шампань	
A-TG-300-05	3000	aluminium / aluminium / алюминий	
A-TG-300-10		biały / white / белый	
A-TG-300-90		szampan / champagne / шампань	
A-TG-405-05	4050	aluminium / aluminium / алюминий	
A-TG-405-10		biały / white / белый	
A-TG-405-90		szampan / champagne / шампань	
A-TG-600-05	6000	aluminium / aluminium / алюминий	
A-TG-600-90		szampan / champagne / шампань	



Torny dolny EVO  
Bottom track EVO  
Нижняя направляющая EVO







	 L mm		
A-TDEVO-170-05	1700	aluminium / aluminium / алюминий	aluminium aluminium алюминий
A-TDEVO-170-90		szampan / champagne / шампань	
A-TDEVO-235-05	2350	aluminium / aluminium / алюминий	
A-TDEVO-235-90		szampan / champagne / шампань	
A-TDEVO-300-05	3000	aluminium / aluminium / алюминий	
A-TDEVO-300-10		biały / white / белый	
A-TDEVO-300-90		szampan / champagne / шампань	
A-TDEVO-405-05	4050	aluminium / aluminium / алюминий	
A-TDEVO-405-10		biały / white / белый	
A-TDEVO-405-90		szampan / champagne / шампань	
A-TDEVO-600-05	6000	aluminium / aluminium / алюминий	
A-TDEVO-600-90		szampan / champagne / шампань	



Maskownica EVO  
Masking cover EVO  
Декоративная накладка







	 L mm		
A-MEVO-170-05	1700	aluminium / aluminium / алюминий	aluminium aluminium алюминий
A-MEVO-170-90		szampan / champagne / шампань	
A-MEVO-235-05	2350	aluminium / aluminium / алюминий	
A-MEVO-235-90		szampan / champagne / шампань	
A-MEVO-300-05	3000	aluminium / aluminium / алюминий	
A-MEVO-300-10A		biały / white / белый	
A-MEVO-300-90		szampan / champagne / шампань	
A-MEVO-405-05	4050	aluminium / aluminium / алюминий	
A-MEVO-405-10		biały / white / белый	
A-MEVO-405-90		szampan / champagne / шампань	



Tor dolny PRO  
Bottom track PRO  
Нижняя направляющая PRO







	 L mm		
A-TDPRO-170-05	1700	aluminium / aluminium / алюминий	aluminium aluminium алюминий
A-TDPRO-170-90		szampan / champagne / шампань	
A-TDPRO-235-05	2350	aluminium / aluminium / алюминий	
A-TDPRO-235-90		szampan / champagne / шампань	
A-TDPRO-300-05	3000	aluminium / aluminium / алюминий	
A-TDPRO-300-90		szampan / champagne / шампань	
A-TDPRO-405-05	4050	aluminium / aluminium / алюминий	
A-TDPRO-405-90		szampan / champagne / шампань	
A-TDPRO-600-05	6000	aluminium / aluminium / алюминий	
A-TDPRO-600-90		szampan / champagne / шампань	



Maskownica PRO  
Masking cover PRO  
Декоративная накладка PRO



	 L mm		
A-MPRO-170-05	1700	aluminium / aluminium / алюминий	aluminium aluminium алюминий
A-MPRO-170-90		szampan / champagne / шампань	
A-MPRO-235-05	2350	aluminium / aluminium / алюминий	
A-MPRO-235-90		szampan / champagne / шампань	
A-MPRO-300-05	3000	aluminium / aluminium / алюминий	
A-MPRO-300-90		szampan / champagne / шампань	
A-MPRO-405-05	4050	aluminium / aluminium / алюминий	
A-MPRO-405-90		szampan / champagne / шампань	



Listwa górna 18/4 mm  
Top strip 18/4 mm  
Профиль горизонтальный верхний 18/4 мм





	 L mm		
A-LG18-170-05	1700	aluminium / aluminium / алюминий	aluminium aluminium алюминий
A-LG18-170-90		szampan / champagne / шампань	
A-LG18-235-05	2350	aluminium / aluminium / алюминий	
A-LG18-235-90		szampan / champagne / шампань	
A-LG18-300-05	3000	aluminium / aluminium / алюминий	
A-LG18-300-10		biały / white / белый	
A-LG18-300-90	szampan / champagne / шампань		
A-LG18-405-05	4050	aluminium / aluminium / алюминий	
A-LG18-405-90		szampan / champagne / шампань	
A-LG18-600-05	6000	aluminium / aluminium / алюминий	
A-LG18-600-90		szampan / champagne / шампань	



Listwa dolna 18/4 mm  
 Bottom strip 18/4 mm  
 Профиль горизонтальный нижний 18/4 мм







			
A-LD18-170-05	1700	aluminium / aluminium / алюминий	aluminium aluminium алюминий
A-LD18-170-90		szampan / champagne / шампань	
A-LD18-235-05	2350	aluminium / aluminium / алюминий	
A-LD18-235-90		szampan / champagne / шампань	
A-LD18-300-05	3000	aluminium / aluminium / алюминий	
A-LD18-300-10		biały / white / белый	
A-LD18-300-90		szampan / champagne / шампань	
A-LD18-405-05	4050	aluminium / aluminium / алюминий	
A-LD18-405-90		szampan / champagne / шампань	
A-LD18-600-05	6000	aluminium / aluminium / алюминий	
A-LD18-600-90		szampan / champagne / шампань	



Listwa górna 10/4 mm  
Top strip 10/4 mm  
Профиль горизонтальный верхний 10/4 мм







	 L mm		
A-LG10-170-05	1700	aluminium / aluminium / алюминий	aluminium aluminium алюминий
A-LG10-235-05	2350	aluminium / aluminium / алюминий	
A-LG10-235-90		szampan / champagne / шампань	
A-LG10-300-05	3000	aluminium / aluminium / алюминий	
A-LG10-300-10		biały / white / белый	
A-LG10-300-90		szampan / champagne / шампань	
A-LG10-405-05	4050	aluminium / aluminium / алюминий	
A-LG10-405-90		szampan / champagne / шампань	
A-LG10-600-05	6000	aluminium / aluminium / алюминий	
A-LG10-600-90		szampan / champagne / шампань	



Listwa dolna 10/4 mm  
Bottom strip 10/4 mm  
Профиль горизонтальный нижний 10/4 мм



	 L mm		
A-LD10-170-05	1700	aluminium / aluminium / алюминий	aluminium aluminium алюминий
A-LD10-235-05	2350	aluminium / aluminium / алюминий	
A-LD10-235-90		szampan / champagne / шампань	
A-LD10-300-05	3000	aluminium / aluminium / алюминий	
A-LD10-300-10		biały / white / белый	
A-LD10-300-90		szampan / champagne / шампань	
A-LD10-405-05	4050	aluminium / aluminium / алюминий	
A-LD10-405-90		szampan / champagne / шампань	
A-LD10-600-05	6000	aluminium / aluminium / алюминий	
A-LD10-600-90		szampan / champagne / шампань	







Listwa górna FL 10/4 mm

Top strip FL 10/4 mm

Профиль горизонтальный верхний FL 10/4 мм



	 L mm		
A-LG10FL-235-05	2350	aluminium / aluminium / алюминий	aluminium aluminium алюминий
A-LG10FL-235-90		szampan / champagne / шампань	
A-LG10FL-300-05	3000	aluminium / aluminium / алюминий	
A-LG10FL-300-10		biały / white / белый	
A-LG10FL-300-90		szampan / champagne / шампань	







Listwa dolna FL 10 /4 mm

Bottom strip FL 10/4 mm

Профиль горизонтальный нижний FL 10/4 мм







	 L mm		
A-LD10FL-235-05	2350	aluminium / aluminium / алюминий	aluminium aluminium алюминий
A-LD10FL-235-90		szampan / champagne / шампань	
A-LD10FL-300-05	3000	aluminium / aluminium / алюминий	
A-LD10FL-300-10		biały / white / белый	
A-LD10FL-300-90		szampan / champagne / шампань	



## Kątownik Angle bar Профиль угловой







	 L mm		
A-K18-300-05	3000	aluminium / aluminium / алюминий	aluminium aluminium алюминий
A-K18-300-10		biały / white / белый	
A-K18-300-90		szampan / champagne / шампань	



## Profil C18 Profile C18 Профиль C18







	 L mm		
A-C18-300-05	3000	aluminium / aluminium / алюминий	aluminium aluminium алюминий
A-C18-300-10		biały / white / белый	
A-C18-300-90		szampan / champagne / шампань	



## Profil T 18 Profile T18 Профиль T18







	 L mm		
A-T18-300-05	3000	aluminium / aluminium / алюминий	aluminium aluminium алюминий
A-T18-300-10		biały / white / белый	
A-T18-300-90		szampan / champagne / шампань	



Profil H16  
Profile H16  
Профиль H16



	 mm		
A-H16-300-05	3000	aluminium / aluminium / алюминий	aluminium aluminium алюминий
A-H16-300-90		szampan / champagne / шампань	







+



Profil H18  
Profile H18  
Профиль H18







	 mm		
A-H18-300-05	3000	aluminium / aluminium / алюминий	aluminium aluminium алюминий
A-H18-300-10		biały / white / белый	
A-H18-300-90		szampan / champagne / шампань	



Profil HR18  
Profile HR18  
Профиль HR18





	 mm		
A-HR18-300-05	3000	aluminium / aluminium / алюминий	aluminium aluminium алюминий
A-HR18-300-10		biały / white / белый	
A-HR18-300-90		szampan / champagne / шампань	





Profil HRS18  
Profile HRS18  
Профиль HRS18



	 L mm		
A-HRS18-170-05	1700	aluminium / aluminium / алюминий	aluminium aluminium алюминий
A-HRS18-170-90		szampan / champagne / шампань	
A-HRS18-235-05	2350	aluminium / aluminium / алюминий	
A-HRS18-235-90		szampan / champagne / шампань	
A-HRS18-300-05	3000	aluminium / aluminium / алюминий	
A-HRS18-300-90		szampan / champagne / шампань	
A-HRS18-405-05	4050	aluminium / aluminium / алюминий	
A-HRS18-405-90		szampan / champagne / шампань	
A-HRS18-600-05	6000	aluminium / aluminium / алюминий	
A-HRS18-600-90		szampan / champagne / шампань	



Profil HR10  
Profile HR10  
Профиль HR10







	 L mm		
A-HR10-170-05	1700	aluminium / aluminium / алюминий	aluminium aluminium алюминий
A-HR10-235-05	2350	aluminium / aluminium / алюминий	
A-HR10-235-90		szampan / champagne / шампань	
A-HR10-300-05	3000	aluminium / aluminium / алюминий	
A-HR10-300-10		biały / white / белый	
A-HR10-300-90		szampan / champagne / шампань	
A-HR10-405-05	4050	aluminium / aluminium / алюминий	
A-HR10-405-90		szampan / champagne / шампань	
A-HR10-600-05	6000	aluminium / aluminium / алюминий	
A-HR10-600-90		szampan / champagne / шампань	



Profil HRS10  
Profile HRS10  
Профиль HRS10







	 L mm		
A-HRS10-170-05	1700	aluminium / aluminium / алюминий	aluminium aluminium алюминий
A-HRS10-235-05	2350		
A-HRS10-300-05	3000	szampan / champagne / шампань	
A-HRS10-300-90		aluminium / aluminium / алюминий	
A-HRS10-405-05	4050		
A-HRS10-600-05	6000		



Profil HR10 FL  
Profile HR10 FL  
Профиль HR10 FL





	 L mm		
A-HR10FL-300-05	3000	aluminium / aluminium / алюминий	aluminium aluminium алюминий
A-HR10FL-300-10		biały / white / белый	
A-HR10FL-300-90		szampan / champagne / шампань	



Prowadnik górny PG-18  
Top roller PG-18  
Верхний ролик PG-18





		
A-PG-18	50	stal, tworzywo steel, plastic сталь, пластмасса



Prowadnik górny PGR-18  
Top roller PGR-18  
Верхний ролик PGR-18





		
A-PGR-18	50	stal, tworzywo steel, plastic сталь, пластмасса



Prowadnik górny PGR-10  
Top roller PGR-10  
Верхний ролик PGR-10





		
A-PGR-10	50	stal, tworzywo steel, plastic сталь, пластмасса



Prowadnik górny PGR-10 symetryczny  
 Top roller PGR-10 symmetrical  
 Верхний ролик PGR-10 симметричный





		
A-PGR-10S	50	stal, tworzywo steel, plastic сталь, пластмасса



Płytk dystansowa  
 Spacer plate  
 Распорная пластина





		
A-DPG-16	50	stal steel сталь





Wózek dolny EVO  
 Bottom roller EVO  
 Нижний ролик EVO



		
A-WD-EVO	50	stal, tworzywo steel, plastic сталь, пластмасса





Wózek dolny PRO  
Bottom roller PRO  
Нижний ролик PRO

		
A-WD-PRO	50	stal, tworzywo steel, plastic сталь, пластмасса





Wózek dolny EVO rama  
Bottom roller EVO frame  
Нижний ролик EVO для рамной системы

		
A-WDR-EVO	50	stal, tworzywo steel, plastic сталь, пластмасса





Wózek dolny PRO rama  
Bottom roller PRO frame  
Нижний ролик PRO для рамной системы

		
A-WDR-PRO	50	stal, tworzywo steel, plastic сталь, пластмасса



Pozycjoner górny  
Top positioner  
Верхний стопор





		
A-PTG	50	tworzywo plastic пластмасса



Pozycjoner dolny PRO  
Bottom positioner PRO  
Нижний стопор PRO



		
A-PTD	50	stal steel сталь





Szczotka odbojowa 4,8x4  
Buffer strip 4,8x4  
Буферная щётка 4,8x4



		
A-S0-48X4	szary	tworzywo plastic пластмасса



Szczotka odbojowa szeroka 14,5x4  
Buffer strip wide 14,5x4  
Буферная щётка широкая 4,8x4

		
A-SO-145X4	szary / gray / серый	tworzywo plastic пластмасса
A-SO-145X4-10	biały / white / белый	
A-SO-145X4-20	czarny / black / чёрный	

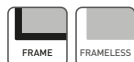

Szczotka przeciwkurzowa bez kleju 4,8x7  
Anti-dust strip without glue 4,8x7  
Противопылевая щётка без клея 4,8x7

		
A-SP-48X7	szary gray серый	tworzywo plastic пластмасса



Szczotka przeciwkurzowa z klejem 7x12  
Anti-dust strip with glue 7x12  
Противопылевая щётка на клеевой основе 7x12

		
A-SP-7X12	szary gray серый	tworzywo plastic пластмасса

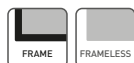

Szczotka przeciwkurzowa bez kleju 4,8x12  
Anti-dust strip without glue 4,8x12  
Противопылевая щётка 4,8x12 (вставная)

		
A-SP-48X12	szary gray серый	tworzywo plastic пластмасса

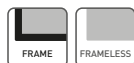

Klin do rączek  
Wedge for handle  
Клин для профиль-ручки



		
A-KR-4	biały white белый	tworzywo plastic пластмасса



Klin do listew poziomych  
Wedge for horizontal strips  
Клин для горизонтальных профилей



		
A-KLP-4	biały white белый	tworzywo plastic пластмасса



Uszczelka typ CH twarda  
Seal type CH, hard  
Уплотнитель типа CH, твердый



		
A-USZCZ-CH4	przeźroczysty transparent прозрачный	tworzywo plastic пластмасса





Uszczelka typ U, średnio twarda  
Gasket U, medium hard  
Уплотнитель тип U, средней твердости



		
A-USZCZ-U4	przezroczysty transparent прозрачный	tworzywo plastic пластмасса



Uszczelka typ CH miękka  
Seal type CH, soft  
Уплотнитель типа CH, мягкий



NEW

		
A-USZCZ-CHM4	przezroczysty transparent прозрачный	tworzywo plastic пластмасса



Blachowkręt 6,3x40  
Steel metal screw 6,3x40  
Сборочный винт 6,3x40





	
A-B63-40	stal steel сталь



Blachowkręt 6,3x32  
Steel metal screw 6,3x32  
Сборочный винт 6,3x40





	
A-B63-32	stal steel сталь



Spowalnicz SIMON skrajny  
Internal soft closing damper SIMON  
Боковой доводчик SIMON





		
A-SOFT-30	30	stal, tworzywo steel, plastic сталь, пластмасса
A-SOFT-50	50	



Spowalnicz SIMON środkowy  
Internal soft closing damper SIMON  
Центральный доводчик SIMON





		
A-MSOFT-RAMA	50	stal, tworzywo steel, plastic сталь, пластмасса



Zestaw adaptera do spowalniacza środkowego  
 Adapter set for soft closing damper  
 Адаптер для доводчика



		
A-MSOFT-ADAPT	50	stal steel сталь



Ręczny przyrząd wiertarski z dociskiem  
 Hand drilling tool with locking screws  
 Ручной сверильный кондуктор с зажимом



	
A-PW-RC-DOC	stal steel сталь

MITO  
MITO  
MITO

			 L mm	 kg ↓				
	Tor MITO Track MITO Направляющая MITO	A-TMITO-200-05	200	50				
		A-TMITO-250-05	250				aluminium aluminium алюминий	aluminium aluminium алюминий
		A-TMITO-250-00					surowe aluminium raw aluminium сырой алюминий	
		A-TMITO-300-05	300				aluminium aluminium алюминий	
	Pozycjoner Positioner Стопор	A-POZ-MITO	-		szary gray серый	tworzywo plastic пластмасса		
	Wózek górny Top guide Верхний проводник	A-SG-MITO	-		ocynk zinc оцинковка	stal, tworzywo steel, plastic сталь, пластмасса		
	Wózek dolny z łożyskiem kulkowym Bottom roller with ball bearing Нижний ролик с шариковым подшипником	A-RD-MITO	-					



Zestaw MITO PLUS  
MITO PLUS set  
MITO PLUS комплект



2 wózki górne ze sprężyną, 2 wózki dolne z łożyskiem kulkowym, 1 pozycjoner, komplet wkrętów

2 top rollers with spring, 2 bottom ball bearing rollers, 1 positioner, set of screws

2 верхних проводника с пружиной, 2 нижних ролика с шариковым подшипником, 1 стопор, комплект шурупов

		 kg ↓		
A-MITO-PLUS	50	ocynk / zink / оцинковка	stal / steel / сталь	



Zestaw OVERLINE  
OVERLINE set  
OVERLINE комплект



2 szt. wózków zewnętrznych, 2 szt. wózków wewnętrznych, 2 szt. pozycjonerów, 2 szt. prowadników dolnych ślizgowych drzwi zewnętrznych, 2 szt. prowadników dolnych ślizgowych drzwi wewnętrznych

2 external rollers, 2 internal rollers, 2 positioners, 2 bottom slides for external door, 2 bottom slides of internal door

Внешние ролики-2шт., внутренние ролики-2шт., нижние ходовые элементы внешней двери-2 шт., нижние ходовые элементы внутренней двери-2 шт., позиционер-2 шт.

A-SN-FSET	50	ocynk / zink / оцинковка	stal, tworzywo / steel, plastic / сталь, пластмасса

	mm	kg			
	A-SN-R19RIV-270-05	-			
	2700				
	A-SN-K19-270-05	-	aluminium aluminium aluminiowy	aluminium aluminium алюминий	
	A-C18-300-05	3000	-		
	A-SN-TG-405-00	4050	50	surowe aluminium raw aluminium сырой алюминий	stal steel сталь
	A-SN-TDS-405-00				aluminium aluminium алюминий
	A-SN-SOFT-25	-	25	szary gray серый	tworzywo plastic пластмасса
	A-SN-SOFT-40	-	40		
	A-SN-ADSET	-	-	-	stal, tworzywo steel, plastic сталь, пластмасса



## Zestaw OVERLINE PLUS

### OVERLINE PLUS set

### OVERLINE PLUS комплектация



2 szt. wózków zewnętrznych, 2 szt. wózków wewnętrznych, 2 szt. prowadników dolnych tocznych drzwi zewnętrznych, 2 szt. prowadników dolnych tocznych drzwi wewnętrznych, 1 zestaw wkrętów

2 external rollers, 2 internal rollers, 2 bottom slides for external door, 2 bottom slides for internal door, screws

Составляющие: внешние ролики-2шт., внутренние ролики-2шт., нижние ходовые элементы внешней двери-2 шт., нижние ходовые элементы внутренней двери-2 шт., 1 кпл. шурупов

A-SN-HSET1	50	ocynk / zink / оцинковка	stal, tworzywo / steel, plastic / сталь, пластмасса				
	Rączka RIVA Handle RIVA Ручка RIVA	A-SN-R19RIV-270-05	2700	-	aluminium aluminium алюминий	aluminium aluminium алюминий	
	Profil C19 Handle C19 Ручка C19	A-SN-K19-270-05		-			
	Profil C18 Handle C18 Ручка C18	A-C18-300-05	3000	-			
	Tor górny Top track Верхняя направляющая	A-SN-TG-405-00	4050	-	surowe aluminium raw aluminium сырой алюминий	stal steel сталь	
	Tor dolny Bottom track Нижняя направляющая	A-SN-TDT-405-00		-		aluminium aluminium алюминий	
	Spowalnicz Soft closing damper доводчик	A-SN-SOFT-25	-	25	-	tworzywo plastic пластмасса	
		A-SN-SOFT-40	-	40	-		
	Zestaw do spowalnicza Soft closing damper set доводчик комплектация 1szt. aktywator drzwi zew. i 1 szt. wew., 4 szt. adapterów, 1 zestaw wkrętów 1pc. activator outer door and 1 pc. inner door, 4 pcs. adapter, 1 screw set активатор внеш. двери-1 шт., активатор внутр. двери-1 шт., адаптер-4 шт., 1кпл. шурупов	A-SN-ADSET	-	-	-	stal, tworzywo steel, plastic сталь, пластмасса	

## Prostownica Warped door straightener Стяжка-выпрямитель

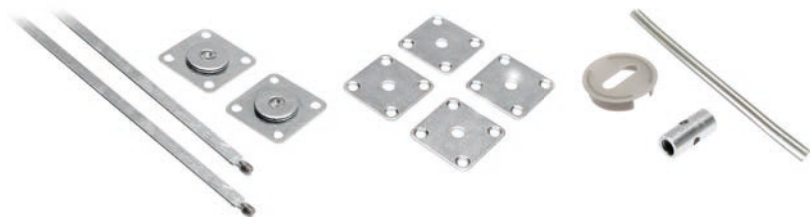

2 szt. listwy ściągające, 2 szt. płytki naciągające, 4 szt. płytki dociskowej, zaślepka, tuleja pozycjonująca, klucz do regulacji  
Tightening strip 2 pcs, tensioning plate 2 pcs, pressure plate 4 pcs, cover cap, positioning sleeve, adjustment spanner  
Планка с резьбой 2 шт., натяжная пластина 2 шт., прижимная пластина 4 шт., заглушка, зажимная гильза, ключ для регулировки



A-SN-SDP-TU

50

ocynk / zink / оцинковка

stal, tworzywo / steel, plastic / сталь, пластмасса





## Zestaw QUANTUM

### QUANTUM set

### Комплект QUANTUM



2 szt. wózków, 2 szt. stoperów, 2 szt. przewodników, komplet wkrętów  
 Rollers 2 pcs, stoppers 2 pcs, guide 2pcs, screw set  
 Ролики - 2 шт., стопор - 2 шт., проводник - 2 шт., комплект шурупов

						
A-BUDP-SET	50	aluminium / aluminium / алюминий	stal, tworzywo / steel, plastic / сталь, пластмасса			
						
	Tor górny Top track Верхняя направляющая	A-TG-BUD-200-00 A-TG-BUD-300-00 A-TG-BUD-400-00	2000 3000 4000	50	surowe aluminium raw aluminium сырой алюминий	aluminium aluminium алюминий
	Uchwyt boczny Side holder Боковое крепление	A-BUD-UB	-		ocynk zink оцинковка	stal steel сталь
	Uchwyt górny Top holder Верхнее крепление	A-BUD-UG	-		aluminium aluminium алюминий	aluminium aluminium алюминий
	Uchwyt maskownicy toru górnego Top track masking cover holder Держатель декоративной панели	A-BUD-UM	60		szary gray серый	stal, tworzywo steel, plastic сталь, пластмасса
	Uchwyt do ramy (4 szt) Frame holder (4 pcs) Крепление плиты	A-BUD-UR	-		ocynk zink оцинковка	stal steel сталь
	Uchwyt do płyty Board holder Держатель для плиты	A-BUD-UP	-			







## ÓŚWIETLENIE MEBLOWE FURNITURE LIGHTING МЕБЕЛЬНОЕ ОСВЕЩЕНИЕ

Taśmy led Furniture lighting Светодиодные ленты	414 – 415
Profile LED LED profiles Профили LED	416 – 433
Oprawy led Led strips Светодиодные светильники	434 – 452
Oprawy halogenowe Led fixtures Галогенные светильники	453 – 454
Akcesoria Accessories Аксессуары	455 – 472
Przedłużacze biurkowe Electrical installation equipment Выдвижные розетки	473 – 479





ТаЅма LED FLASH  
LED strip FLASH  
Светоодиодная лента FLASH



	LD-3528-300-20-ZB	12 VDC 4,8 W/m	300 lm/m		20	120°	5	8	60/m	5 cm
	LD-3528-300-20-NE									
	LD-3528-300-20-CB									
	LD-3528-300-20-NI			niebieski blue синий						
	LD-3528-300-65-ZB	12 VDC 4,8 W/m	280 lm/m		65					
	LD-3528-300-65-CB									
	LD-3528-600-20-ZB	12 VDC 9,6 W/m	550 lm/m		20	120°	5	8	120/m	2,5 cm
	LD-3528-600-20-CB									
	LD-3528-600-65-ZB	12 VDC 9,6 W/m	520 lm/m		65					
	LD-3528-600-65-CB									
	LD-2835-300-20-ZB	12 VDC 6 W/m	750 lm/m		20	120°	5	8	60/m	5 cm
	LD-2835-300-20-NE									
	LD-2835-300-20-CB									
	LD-2835-300-65-ZB	12 VDC 6 W/m	700 lm/m		65					
	LD-2835-300-65-CB									
	LD-5050-300-20-ZB	12 VDC 14,4 W/m	900 lm/m		20	120°	5	10	60/m	5 cm
	LD-5050-300-20-CB									
	LD-5050-300-65-ZB	12 VDC 14,4 W/m	850 lm/m		65					
	LD-5050-300-65-CB									
	LD-5630-300-20-ZB	12 VDC 16 W/m	1750 lm/m		20	120°	5	10	60/m	5 cm
	LD-5630-300-20-CB									
	LD-5630-300-65-ZB	12 VDC 16 W/m	1700 lm/m		65					
	LD-5630-300-65-CB									
	LD-RGB-150-20	12 VDC 7,2 W/m	450 lm/m		20	120°	5	10	30/m	10 cm
	LD-RGB-150-65				65					



ТаЅма LED FLASH 50 m  
LED FLASH strip 50 m  
Светоодиодная лента LED FLASH

NEW



LD-2835-300-20-ZB-50	12 VDC 6 W/m	750 lm/m	● 6500 K	20	120°	50 m	8 mm	60/m	5 cm
LD-2835-300-20-NE-50			● 5000 K						
LD-2835-300-20-CB-50			● 3200 K						
LD-3528-300-20-CB-50	12 VDC 4,8 W/m	300 lm/m	● 6500 K						
LD-3528-300-20-NE-50			● 5000 K						
LD-3528-300-20-ZB-50			● 3200 K						



ТаЅма LED BIS  
LED strip BIS  
Светоодиодная лента BIS

NEW



LD-3528B-300-20-CB	12 VDC 4,8 W/m	300 lm/m	● 3200 K	20	120°	5 m	8 mm	60/m	5 cm
LD-3528B-300-20-ZB			● 6500 K						
LD-3528B-300-65-CB		280 lm/m	● 3200 K						
LD-3528B-300-65-ZB			● 6500 K						





Profil GLAX nakładany mini  
GLAX profile mini surface mounted  
Профиль GLAX накладной мини

NEW

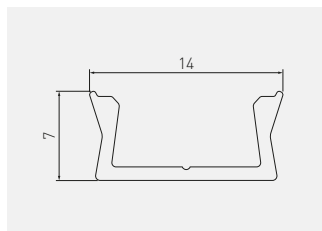

	 L m			
PA-GLAXMNK-AL	2	profil profile профиль	srebrny silver серебристый	aluminium aluminium алюминий
PA-GLAXMNK3M-AL	3			
PA-OSMLGLAXM-00	2	ostonka mini cover mini крышка мини	mleczna frosted молочная	tworzywo plastic пластик
PA-OSMLGLAXM3M-00	3		transparentna transparent прозрачная	
PA-OSTRGLAXM-00	2			
PA-OSTRGLAXM3M-00	3			
PA-OSMLGLAXMK-00	2	ostonka kwadratowa cover square крышка квадратная	mleczna frosted молочная	
PA-OSMLGLAXM0-00		ostonka okrągła cover round крышка круглая		
PA-ZASGLAXMNK-00	-	zaślepka standard end cap standard заглушка стандартная	srebrny silver серебристый	ABS
PA-ZASGLAXMNKK-00	-	zaślepka kwadratowa end cap square заглушка квадратная		
PA-ZASGLAXMNKO-00	-	zaślepka okrągła end cap round заглушка круглая		

Ostonki / Covers / Крышки:



PA-OSMLGLAXM-00  
PA-OSMLGLAXM3M-00

PA-OSTRGLAXM-00  
PA-OSTRGLAXM3M-00

**NEW**  
PA-OSMLGLAXM0-00

**NEW**  
PA-OSMLGLAXMK-00

Zaślepki / End caps / Заглушки:



PA-ZASGLAXMNK-00

PA-ZASGLAXMNKK-00

PA-ZASGLAXMNKO-00

Profil GLAX nakładany mini, wysoki  
 Profile GLAX - surface mounted mini, high  
 Профиль GLAX накладной мини, высокий

NEW

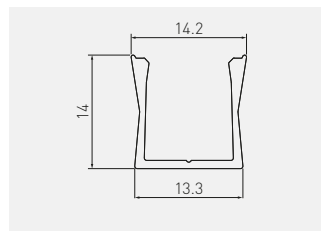





				
PA-GLAXMNKW-AL	2	profil profile профиль	srebrny silver серебристый	aluminium aluminium алюминий
PA-OSMLGLAXM-00	2	ostonka mini cover mini крышка мини	mleczna frosted молочная	tworzywo plastic пластик
PA-OSTRGLAXM-00			transparentna transparent прозрачная	
PA-ZASGLAXMNKW-00	-	zaślepka end cap заглушка	srebrny silver серебристый	ABS

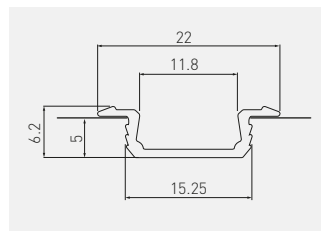

Profil GLAX wpuszczany  
 Profile GLAX - recessed  
 Профиль LED GLAX, врезной



	 m			
PA-GLAX-AL	2	profil profile профиль	srebrny silver серебристый	aluminium aluminium алюминий
PA-GLAX3M-AL	3			
PA-OSMLGLAX-00	2	ostonka cover крышка	mleczna frosted молочная	tworzywo plastic пластик
PA-OSMLGLAX3M-00	3			
PA-OSTRGLAX-00	2		transparentna transparent прозрачная	
PA-OSTRGLAX3M-00	3			
PA-ZASGLAX-00	-	zaślepka end cap заглушка	srebrny silver серебристый	ABS

Ostonki / Covers / Крышки:



PA-OSMLGLAXM-00

PA-OSTRGLAXM-00

Zaślepka / End cap / Заглушка:



PA-ZASGLAX-00



Profil GLAX wpuszczany, wysoki  
Profile GLAX - recessed  
Профиль LED GLAX, врезной

NEW

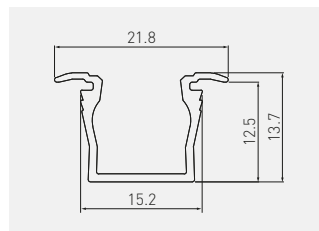



PA-GLAXMW-AL	2	profil profile профиль	srebrny silver серебристый	aluminium aluminium алюминий
PA-OSMLGLAXM-00	2	ostonka mini cover mini крышка мини	mleczna frosted молочная	tworzywo plastic пластик
PA-OSMLGLAXMK-00		ostonka kwadratowa cover square крышка квадратная	transparentna transparent прозрачная	
PA-OSTRGLAXM-00		ostonka mini cover mini крышка мини	transparentna transparent прозрачная	
PA-ZASGLAXMW-00	-	zaślepka standard end cap standard заглушка стандартная	srebrny silver серебристый	ABS
PA-ZASGLAXMWK-00	-	zaślepka kwadratowa end cap square заглушка квадратная		

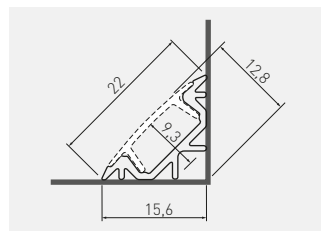

Profil GLAX kątowy  
 GLAX corner profile  
 Профиль GLAX угловой



	 L m			
PA-GLAXKT-AL	2	profil profile профиль	srebrny silver серебристый	aluminium aluminium алюминий
PA-GLAXKT3M-AL	3			
PA-OSMLGLAX-00	2	ostonka cover крышка	mleczna frosted молочная	tworzywo plastic пластик
PA-OSMLGLAX3M-00	3		transparentna transparent прозрачная	
PA-OSTRGLAX-00	3			
PA-OSTRGLAX3M-00	2			
PA-ZASGLAXKT-00	-	zaślepka end cap заглушка	srebrny silver серебристый	ABS

Ostonki / Covers / Крышки:

 PA-OSMLGLAX-00  
 PA-OSMLGLAX3M-00

 PA-OSTRGLAX-00  
 PA-OSTRGLAX3M-00





Zaślepka / End cap / Заглушка:

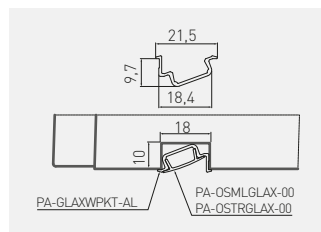

PA-ZASGLAXKT-00

Profil GLAX kątowy, wpuszczany  
 Recessed corner profile GLAX  
 Профиль GLAX, угловой, врезной



				
PA-GLAXWPKT-AL	2	profil profile профиль	srebrny silver серебристый	aluminium aluminium алюминий
PA-OSMLGLAX-00		ostonka cover крышка	mleczna frosted молочная	tworzywo plastic пластик
PA-OSTRGLAX-00			transparentna transparent прозрачная	

Ostonki / Covers / Крышки:



PA-OSMLGLAX-00



PA-OSTRGLAX-00

Profil GLAX kątowy, nakładany  
 GLAX aluminium corner profile – surface mounted  
 Профиль LED GLAX, угловой, накладной

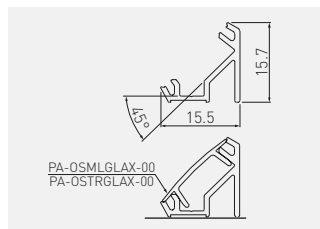

				
PA-GLAXNKKT-AL	2	profil profile профиль	srebrny silver серебристый	aluminium aluminium алюминий
PA-GLAXNKKT3M-AL	3			
PA-OSMLGLAX-00	2	osłonka cover крышка	mleczna frosted молочная	tworzywo plastic пластик
PA-OSMLGLAX3M-00	3		transparentna transparent прозрачная	
PA-OSTRGLAX-00	2			
PA-OSTRGLAX3M-00	3			
PA-OSMLGLAXT-00	2	osłonka trójkątna cover triangular крышка треугольная	mleczna frosted молочная	
PA-ZASGLAXNKKT-00	-	zaślepka standard end cap standard заглушка стандартная	srebrny silver серебристый	ABS
PA-ZASGLAXNKKT-00	-	zaślepka trójkątna end cap triangular заглушка треугольная		

Osłonki / Covers / Крышки:

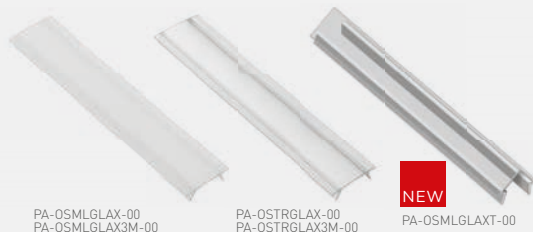
 PA-OSMLGLAX-00  
 PA-OSMLGLAX3M-00

 PA-OSTRGLAX-00  
 PA-OSTRGLAX3M-00

**NEW**

PA-OSMLGLAXT-00

Zaślepki / End caps / Заглушки:





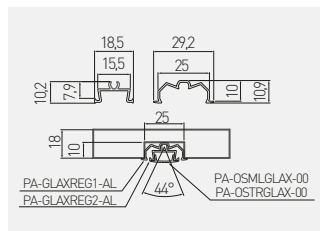

PA-ZASGLAXNKKT-00

PA-ZASGLAXNKKT-00

Profil GLAX z regulowanym kątem  
 Profile GLAX with adjustable angle  
 Профиль GLAX с регулировкой угла



				
PA-GLAXREG1-AL	2	profil profile профиль	srebrny silver серебристый	aluminium aluminium алюминий
PA-GLAXREG2-AL				
PA-OSMLGLAX-00	2	ostonka cover крышка	mleczna frosted молочная	tworzywo plastic пластик
PA-OSTRGLAX-00			transparentna transparent прозрачная	

Ostonki / Covers / Крышки:









PA-OSMLGLAX-00

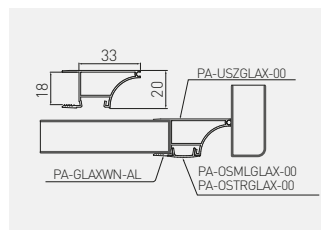

PA-OSTRGLAX-00

Profil GLAX wieńcowy  
Rim profile GLAX  
Профиль GLAX, торцевой









				
PA-GLAXWN-AL	2	profil profile профиль	srebrny silver серебристый	aluminium aluminium алюминий
PA-OSMLGLAX-00		ostonka cover крышка	mleczna frosted молочная	tworzywo plastic пластик
PA-OSTRGLAX-00			transparentna transparent прозрачная	
PA-USZGLAX-00N	10	uszczelka cord gasket уплотнитель	czarny black черный	EPDM

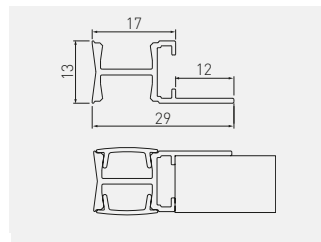

Profil GLAX półkowy mini  
Shelf profile GLAX mini  
Профиль GLAX полочный мини

NEW



	 L m			
PA-GLAXMPK-AL	2	profil profile профиль	srebrny silver серебристый	aluminium aluminium алюминий
PA-OSMLGLAXM-00		ostonka mini cover mini крышка мини	mleczna frosted молочная	tworzywo plastic пластик
PA-OSTRGLAXM-00			transparentna transparent прозрачная	

Ostonki / Covers / Крышки:



PA-OSMLGLAXM-00





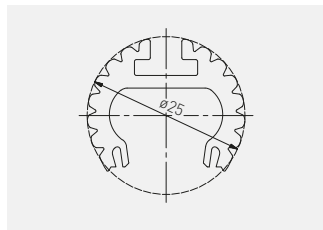

PA-OSTRGLAXM-00

Profil GLAX drążkowy  
GLAX rail profile  
Профиль-штанга GLAX

NEW



				
PA-GLAXDR-AL	2	profil profile профиль	srebrny silver серебристый	aluminium aluminium алюминий
PA-OSMLGLAX-00		oślonka cover крышка	mleczna frosted молочная	tworzywo plastic пластик
PA-OSTRGLAX-00			transparentna transparent прозрачная	
PA-ZASGLAXDR-00	-	zaślepka end cap заглушка	srebrny silver серебристый	ZnAl
PA-ROZGLAX-53	-	rozetka rail socket монтажный крепеж		
PA-ZAWGLAXDR-00	1,5	zawieszka hanger подвес для профиля	chrom chrome хром	stal steel сталь

Ostonki / Covers / Крышки:



PA-OSMLGLAX-00

PA-OSTRGLAX-00

Zaślepka / End cap  
Заглушка



PA-ZASGLAXDR-00

Rozetka / Rail socket  
Монтажный крепеж



PA-ROZGLAX-53

Zawieszka / Hanger  
Подвес для профиля



PA-ZAWGLAXDR-00

NEW



Profil GLAX kątowy, nabijany, jednostronny  
 GLAX aluminium edge profile – single-sided  
 Профиль LED GLAX торцевой, односторонний

NEW

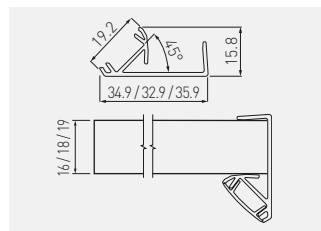

		 BOARD mm	 L mm			
PA-GLAXNB3M16-AL		16	2	profil profile профиль	srebrny silver серебристый	aluminium aluminium алюминий
PA-GLAXNB3M19-AL		16	3			
PA-GLAXNB3M-AL		18	3			
PA-GLAXNB2M19-AL		19	2			
PA-GLAXNB2M16-AL		19	3			
PA-OSMLGLAX-00		-	2	oślonka cover крышка	mleczna frosted молочная	tworzywo plastic пластик
PA-OSMLGLAX3M-00		-	3			
PA-OSTRGLAX-00		-	3			
PA-OSTRGLAX3M-00		-	2		transparentna transparent прозрачная	

Ostonki / Covers / Крышки:



PA-OSMLGLAX-00  
 PA-OSMLGLAX3M-00



PA-OSTRGLAX-00  
 PA-OSTRGLAX3M-00

Profil GLAX, kątowy nabijany, jednostronny (do wypełnienia obrzeżem)  
 GLAX aluminium edge profile – single-sided (option to fill with matching edge banding)  
 Профиль LED GLAX торцевой, кромочный, односторонний

NEW

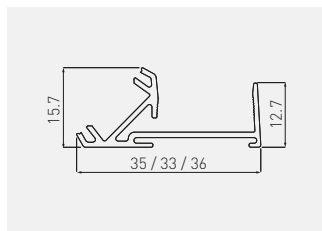

	 BOARD mm	 L mm			
PA-GLAXNBW2M16-AL	16	2	profil profile профиль	srebrny silver серебристый	aluminium aluminium алюминий
PA-GLAXNBW3M16-AL	16	3			
PA-GLAXNBW3M-AL	18	3			
PA-GLAXNBW2M19-AL	19	2			
PA-GLAXNBW3M19-AL	19	3			
PA-OSMLGLAX-00	-	2	ostonka cover крышка	mleczna frosted молочная	tworzywo plastic пластик
PA-OSMLGLAX3M-00	-	3		transparentna transparent прозрачная	
PA-OSTRGLAX-00	-	3			
PA-OSTRGLAX3M-00	-	2			

Ostonki / Covers / Крышки:



PA-OSMLGLAX-00  
 PA-OSMLGLAX3M-00





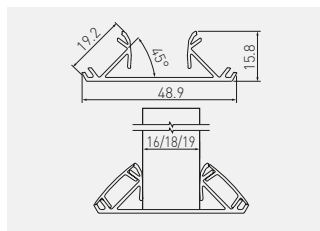

PA-OSTRGLAX-00  
 PA-OSTRGLAX3M-00

Profil GLAX kątowy, nabijany, dwustronny  
 GLAX aluminium edge profile – double sided  
 Профиль LED GLAX торцевой, двухсторонний

NEW



	 BOARD mm	 L m			
PA-GLAXNBD2M16-AL	16	2	profil profile профиль	srebrny silver серебристый	aluminium aluminium алюминий
PA-GLAXNBD3M16-AL	16	3			
PA-GLAXNBD3M-AL	18	3			
PA-GLAXNBD2M19-AL	19	2			
PA-GLAXNBD3M19-AL	19	3			
PA-OSMLGLAX-00	-	2	ostonka cover крышка	mleczna frosted молочная	tworzywo plastic пластик
PA-OSMLGLAX3M-00	-	3		transparentna transparent прозрачная	
PA-OSTRGLAX-00	-	3			
PA-OSTRGLAX3M-00	-	2			

Ostonki / Covers / Крышки:



PA-OSMLGLAX-00  
 PA-OSMLGLAX3M-00



PA-OSTRGLAX-00  
 PA-OSTRGLAX3M-00

Profil GLAX kątowy, nabijany, dwustronny (do wypełnienia obrzeżem)  
 GLAX aluminium edge profile – double sided (option to fill with matching edge banding)  
 Профиль LED GLAX торцевой, кромочный, двухсторонний

NEW

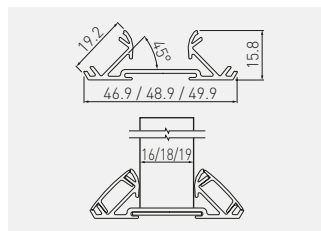

	 BOARD mm	 L mm			
PA-GLAXNBDW2M16-AL	16	2	profil profile профиль	srebrny silver серебристый	aluminium aluminium алюминий
PA-GLAXNBDW3M16-AL	16	3			
PA-GLAXNBDW3M-AL	18	3			
PA-GLAXNBDW2M19-AL	19	2			
PA-GLAXNBDW3M19-AL	19	3			
PA-OSMLGLAX3M-00	-	3	ostonka cover крышка	mleczna frosted молочная	tworzywo plastic пластик
PA-OSTRGLAX3M-00	-		transparentna transparent прозрачная		

Ostonki / Covers / Крышки:



PA-OSMLGLAX3M-00





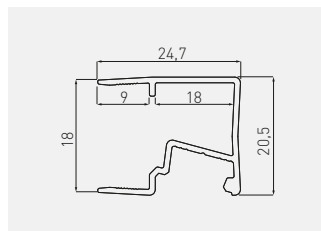

PA-OSTRGLAX3M-00

Profil GLAX kątowy, nabijany, wąski, jednostronny  
 Corner profile GLAX, one-sided, edge mounted  
 Профиль GLAX угловой, накладной, узкий, односторонний

NEW



	 L m			
PA-GLAXMNBW3M-AL	3	profil profile профиль	srebrny silver серебристый	aluminium aluminium алюминий
PA-OSMLGLAXM3M-00		ostonka mini cover mini крышка мини	mleczna frosted молочная	tworzywo plastic пластик
PA-OSTRGLAXM3M-00			transparentna transparent прозрачная	

Ostonki / Covers / Крышки:



PA-OSMLGLAXM3M-00





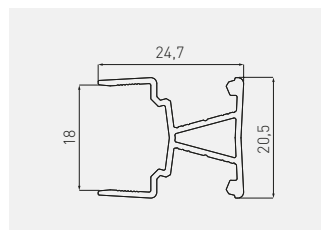

PA-OSTRGLAXM3M-00

Profil GLAX kątowy nabijany, wąski, dwustronny  
 Corner profile GLAX, narrow, two-sided  
 Профиль GLAX угловой, накладной, узкий двусторонний

NEW



				
PA-GLAXMNBW3M-AL	3	profil profile профиль	srebrny silver серебристый	aluminium aluminium алюминий
PA-OSMLGLAXM3M-00		ostonka mini cover mini крышка мини	mleczna frosted молочная	tworzywo plastic пластик
PA-OSTRGLAXM3M-00			transparentna transparent прозрачная	

Ostonki / Covers / Крышки:







PA-OSMLGLAXM3M-00

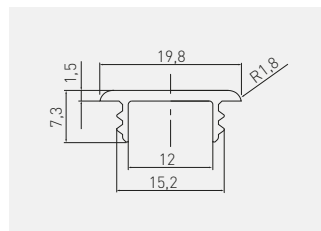

PA-OSTRGLAXM3M-00

Profil GLAX wpuszczany z poliwęglanu  
 Recessed polycarbonate profile GLAX  
 Профиль GLAX врезной из поликарбоната



			
PW-PC31209-00N	2	mleczna / frosted / молочная	tworzywo plastic пластик
PW-PC61209-00		transparentna / transparent / прозрачная	



Оправа VASCO nakładana / wpuszczana  
 Fixture VASCO surface mounted / recessed  
 Светильник VASCO накладной / врезной



LD-VA24CB-10	130 lm	● 3000 K	biały połysk white gloss белый глянец	tworzywo plastic пластик
LD-VA24NE-10		● 4000 K		
LD-VA24ZB-10		● 6000 K		
LD-VA24CB-20		● 3000 K	czarny połysk black gloss черный глянец	
LD-VA24NE-20		● 4000 K		
LD-VA24ZB-20		● 6000 K		
LD-VA24CB-53		● 3000 K	aluminium aluminium алюминий	
LD-VA24NE-53		● 4000 K		
LD-VA24ZB-53		● 6000 K		

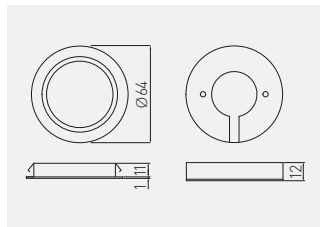

Оправа LUMINO  
 Fixture LUMINO  
 Светильник LUMINO



LD-LU16CB-10	70-85 lm	● 2700 K	biały połysk white gloss белый глянец	tworzywo plastic пластик
LD-LU16NE-10		● 4000 K		
LD-LU16ZB-10		● 6500 K		
LD-LU16CB-20		● 2700 K	czarny połysk black gloss черный глянец	
LD-LU16NE-20		● 4000 K		
LD-LU16ZB-20		● 6500 K		
LD-LU16CB-53		● 2700 K	aluminium aluminium алюминий	
LD-LU16NE-53		● 4000 K		
LD-LU16ZB-53		● 6500 K		

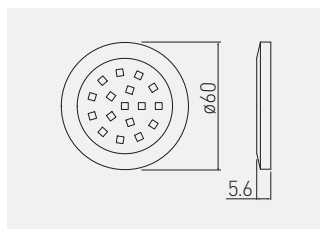



Оправа JOVITA  
 Fixture JOVITA  
 Светильник JOVITA

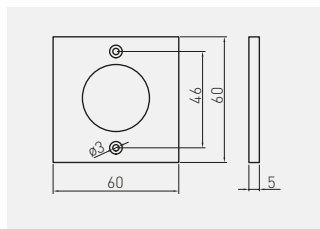

LD-KJVCOB-CB	200 lm	3000 K	aluminium	aluminium
LD-KJVCOB-ZB		6400 K	aluminium	aluminium
			алюминий	алюминий



Оправа JOVITA  
 Fixture JOVITA  
 Светильник JOVITA

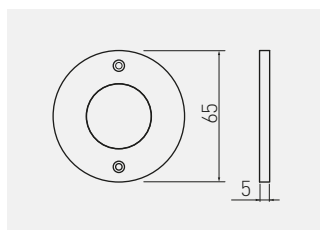

LD-OJVCOB-CB	200 lm	3000 K	aluminium	aluminium
LD-OJVCOB-ZB		6400 K	aluminium	aluminium
			алюминий	алюминий



Оправа JOVITA  
 Fixture JOVITA  
 Светильник JOVITA

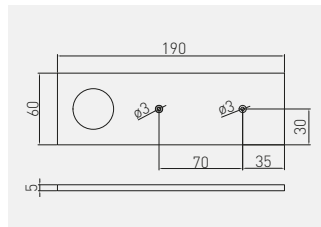

LD-PJVCOB-CB	200 lm	● 3000 K	aluminium	aluminium
LD-PJVCOB-ZB		● 6400 K	aluminium алюминий	aluminium алюминий



Оправа LUGO  
 Fixture LUGO  
 Светильник LUGO

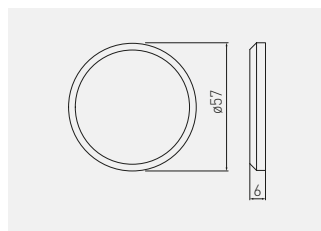

LD-LCG119-53	110 lm	● 3000 K	aluminium	tworzywo plastic пластик
LD-LUG119-53		● 6400 K	aluminium алюминий	
LD-LCG119-40		● 3000 K	chrom	
LD-LUG119-40		● 6400 K	chrome хром	
LD-LCG119-52		● 3000 K	satyna	
LD-LUG119-52		● 6400 K	satyn сатин	



Оправа CASTELLO  
 Fixture CASTELLO  
 Светильник CASTELLO

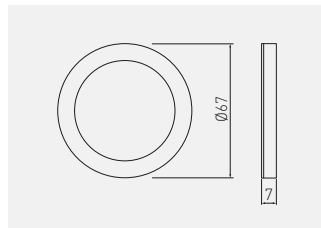

LD-CSN36CB-53	180 lm	3000 K	aluminium aluminium алюминий	tworzywo plastic пластик
LD-CSN36ZB-53		6500 K		



Оправа CASTELLO z włącznikiem  
 Fixture CASTELLO with switch  
 Светильник CASTELLO с выключателем

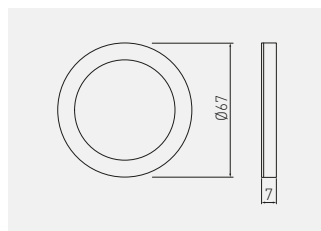

LD-CS36CB-53	180 lm	3200 K	aluminium aluminium алюминий	tworzywo plastic пластик
LD-CS36NE-53		4000 K		
LD-CS36ZB-53		6200 K		



Оправа ESTELLA  
 Fixture ESTELLA  
 Светильник ESTELLA

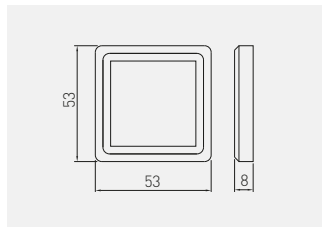

Model	Light Output	Color Temperature	Material	Material
LD-ES21CB-53	90 lm	3000 K	aluminium aluminium алюминий	tworzywo plastic пластик
LD-ES21NE-53	100 lm	4000 K		
LD-ES21ZB-53	110 lm	6400 K		



Оправа CALDAS  
 Fixture CALDAS  
 Светильник CALDAS

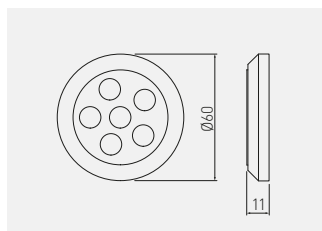

Model	Light Output	Color Temperature	Material	Material
LD-CD06CB-53	190 lm	3000 K	aluminium aluminium алюминий	tworzywo plastic пластик
LD-CD06NE-53		4000 K		
LD-CD06ZB-53		6400 K		



Оправа ISLA  
 Fixture ISLA  
 Светильник ISLA

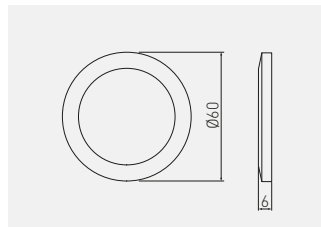

LD-IS09CB-53	56 lm	● 3200 K	aluminium aluminium алюминий	tworzywo plastic пластик
LD-IS09NE-53		● 4000 K		
LD-IS09ZB-53		● 6400 K		



Оправа ALVARO wpuszczana  
 Recessed fixture ALVARO  
 Врезной светильник ALVARO

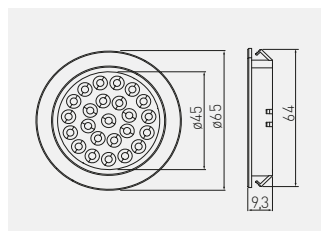

LD-AL24CB-53	130 lm	● 3000 K	aluminium aluminium алюминий	tworzywo plastic пластик
LD-AL24NE-53		● 4000 K		
LD-AL24ZB-53		● 6400 K		



Oprawa trójkątna z włącznikiem  
Triangle fixture with switch  
Треугольный светильник с выключателем

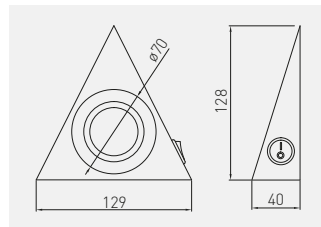

LD-OPT30S-53N	100 lm	● 3000 K	aluminium / aluminium / алюминий	stal steel сталь
LD-OPT60S-53N		● 6400 K		
LD-OPT30S-51N		● 3000 K	stal szcztokowana / brushed steel / шлифованная сталь	
LD-OPT60S-51N		● 6400 K		
LD-OPT30S-52N		● 3000 K	satyna / satin / сатин	
LD-OPT60S-52N		● 6400 K		



Zestaw opraw trójkątnych z włącznikiem  
Triangle fixture kit with switch  
Комплект треугольных светильников с выключателем

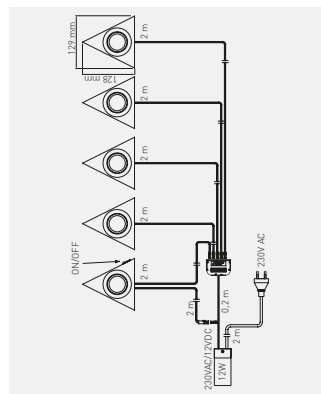

LD-Z50TCB-51	5x100 lm	● 3000 K	stal szcztokowana brushed steel шлифованная сталь	stal, tworzywo steel, plastic сталь, пластмасса



Zestaw opraw CASTELLO z włącznikiem  
 Fixture kit with switch CASTELLO  
 Комплект светильников CASTELLO с выключателем

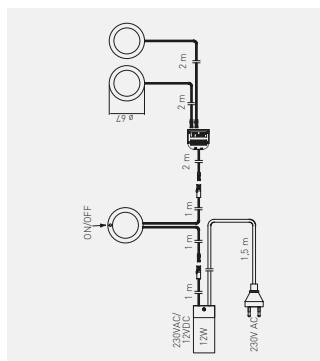

LD-Z3CSCB-53	3x180 lm	3000 K	aluminium / aluminium / алюминий	tworzywo / plastic / пластик



Zestaw opraw CASTELLO z włącznikiem  
 Fixture kit CASTELLO with switch  
 Комплект светильников CASTELLO с выключателем

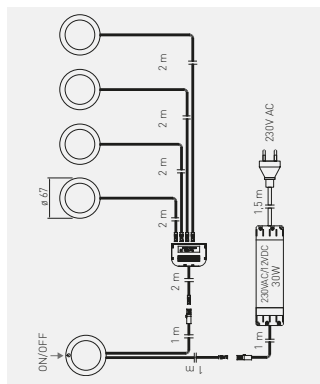

LD-Z5CSCB-53	5x180 lm	3000 K	aluminium / aluminium / алюминий	tworzywo / plastic / пластик



Zestaw opraw LUGO  
 Fixture kit LUGO  
 Комплект светильников LUGO

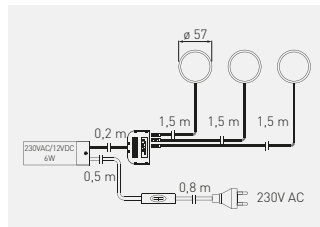

LD-LCG319-53	3x110 lm	3000 K	aluminium / aluminium / алюминий	tworzywo plastic пластик	
LD-LUG319-53		6400 K			
LD-LCG319-40		3000 K	chrom / chrome / хром		
LD-LUG319-40		6400 K			
LD-LCG319-52		3000 K	satyna / satin / сатин		
LD-LUG319-52		6400 K			



Zestaw opraw BARRI  
 Fixture kit BARRI  
 Комплект светильников BARRI

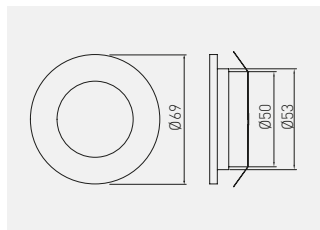

LD-OBP27CB-53	3x80 lm	2700 K	aluminium aluminium алюминий	aluminium, tworzywo aluminium, plastic алюминий, пластмасса	
LD-OBP27ZB-53		6400 K			





Zestaw opraw MARBELLA  
 Fixture kit MARBELLA  
 Комплект светильников MARBELLA

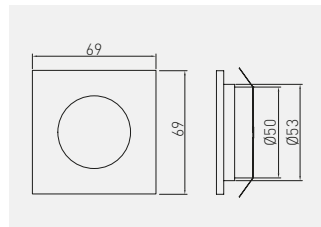

LD-KWP27CB-53	3x80 lm	● 2700 K	aluminium	aluminium, tworzywo aluminium, plastic
LD-KWP27ZB-53		● 6400 K	aluminium алюминий	



Listwa LED z zasilaczem  
 LED strip with power supply  
 Светодиодная планка с трансформатором

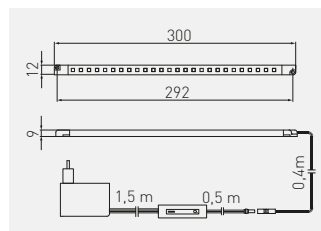

LD-LL27CB-00	140 lm	● 3000 K	chrom	tworzywo plastic
LD-LL27ZB-00		● 6400 K	chrom хром	



Oprawa OVIEDO wpuszczana  
Recessed fixture OVIEDO  
Врезной светильник OVIEDO

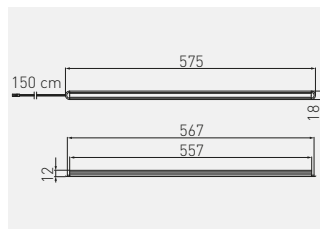

LD-WL2457-53	90 lm	6400 K	aluminium aluminium алюминий	aluminium, tworzywo aluminium, plastic алюминий, пластмасса



Oprawa FRAGA podszafkowa z włącznikiem  
Cabinet fixture with switch FRAGA  
Светильник под шкафчики FRAGA с выключателем

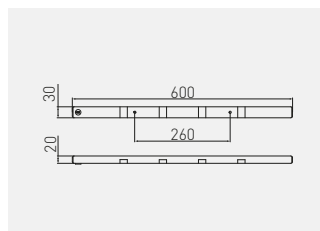

LD-OP408C-53	3 W	90 lm	6400 K	aluminium aluminium алюминий	aluminium, tworzywo aluminium, plastic алюминий, пластмасса
LD-OP608C-53	4,1 W	135 lm			



Оправа ROTA podszafkowa  
 Cabinet ROTA fixture  
 Светильник ROTA под шкафчики

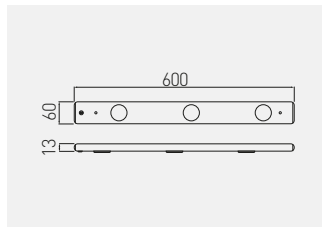

LD-OP456C-53	4,2 W	230 lm	● 6400 K	aluminium aluminium алюминий	aluminium, tworzywo aluminium, plastic алюминий, пластмасса
LD-OP609C-53	5,5 W	310 lm			



Оправа SORIA z czujnikiem zbliżeniowym  
 Fixture with proximity sensor SORIA  
 Светильник с датчиком приближения SORIA

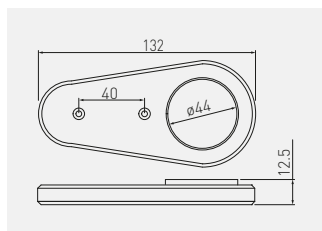

LD-SR16CB-53	90-110 lm	● 3000 K	aluminium aluminium алюминий	aluminium aluminium алюминий
LD-SR16NE-53		● 4000 K		
LD-SR16ZB-53		● 6400 K		



Оправа FOCUS на wysięgniku  
 Fixture with arm FOCUS  
 Светильник типа „дуга” FOCUS

NEW

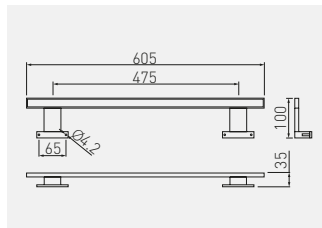

LD-FO120CB-40	740 lm	3000 K	chrom chrome хром	aluminium, tworzywo aluminium, plastic алюминий, пластмасса
LD-FO120ZB-40		6400 K		



Оправа RADIUS на wysięgniku  
 Fixture with arm RADIUS  
 Светильник типа „дуга” RADIUS

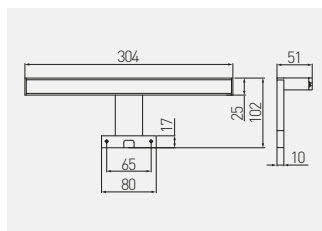

LD-RA60CB-40	300 lm	3000 K	chrom chrome хром	aluminium, tworzywo aluminium, plastic алюминий, пластмасса
LD-RA60ZB-40	350 lm	6400 K		



Оправа MAXIMUS на wysięgniku  
 Fixture with arm MAXIMUS  
 Светильник типа „дуга” MAXIMUS

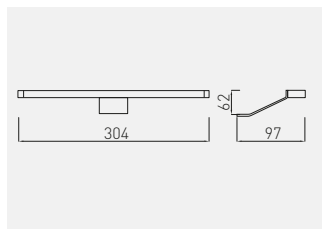

LD-MAX60CB-40N	160 lm	● 3000 K	chrom chrome	aluminium, tworzywo aluminium, plastic алюминий, пластмасса
LD-MAX60ZB-40N		● 6400 K	хром	



Оправа COSTA на wysięgniku  
 Fixture with arm COSTA  
 Светильник типа „дуга” COSTA

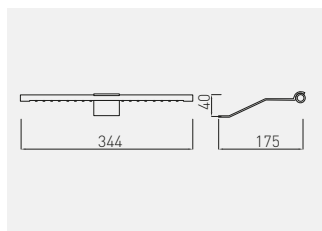

LD-CO20CB-53	100 lm	● 3000 K	aluminium aluminium	aluminium, tworzywo aluminium, plastic алюминий, пластмасса
LD-CO20ZB-53		● 6400 K	алюминий	



Oprawa ABELLA na wysięgniku  
 Fixture with arm ABELLA  
 Светильник типа „дуга” ABELLA

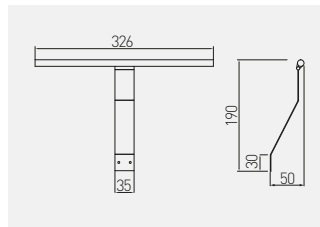

LD-AB18CB-53	460 lm	3000 K	aluminium	stal, aluminium, tworzywo steel, aluminium, plastic
LD-AB18ZB-53		6400 K	aluminium алюминий	



Oprawa EVITA na wysięgniku  
 Fixture with arm EVITA  
 Светильник типа „дуга” EVITA

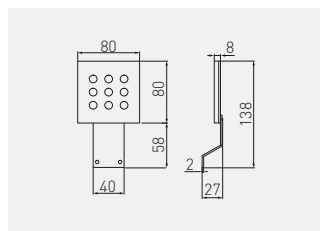

LD-EIW09CB-CZ	120 lm	3000 K	czarny / black / черный	aluminium, tworzywo aluminium, plastic алюминий, пластмасса



Оправа NOELIA na wysięgniku  
 Fixture with arm NOELIA  
 Светильник типа „дуга” NOELIA

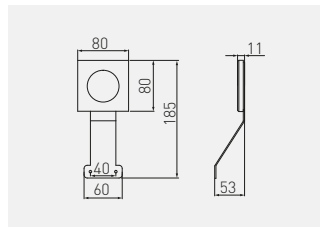

LD-NO24CB-00	330 lm	● 3000 K	aluminium aluminium	aluminium, tworzywo aluminium, plastic
LD-NO24ZB-00		● 6400 K	алюминий	алюминий, пластмасса



Оправа FIDELIA na wysięgniku  
 Fixture with arm FIDELIA  
 Светильник типа „дуга” FIDELIA

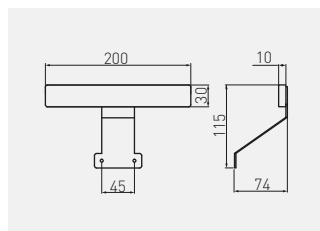

LD-FL36CB-00	155 lm	● 3000 K	aluminium aluminium	aluminium, tworzywo aluminium, plastic
LD-FL36ZB-00	165 lm	● 6400 K	алюминий	алюминий, пластмасса



Оправа CALDERON na wysięgniku  
 Fixture with arm CALDERON  
 Светильник типа „дуга” CALDERON

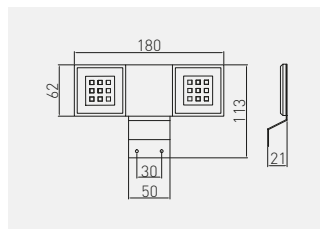

LD-NKW18CB-40	270lm	● 3000 K	chrom	stal, tworzywo
LD-NKW18ZB-40		● 6400 K	chrome хром	steel, plastic сталь, пластмасса



Оправа COMA bezprzewodowa  
 Wireless fixture COMA  
 Беспроводной светильник COMA



LD-IRUSB-53

LD-PIRUSB-53

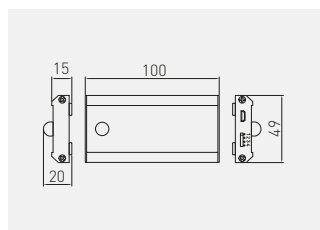

Dodatkowy przewód USB (do ładowania) - 0,5 m w komplecie  
 Additional 0,5m USB cable (for charging)  
 Дополнительный кабель USB (для зарядки) - 0,5 m

LD-IRUSB-53	40-50 lm	● 4000 K	Czujnik zbliżeniowy IR, jedno- lub dwu-biegowy Proximity sensor IR, single or double-pole Датчик движения IR, одно- и многофункциональный	aluminium aluminium алюминий	metal, tworzywo metal, plastic металл, пластик
LD-PIRUSB-53			Czujnik ruchu PIR, jednobiegowy Proximity sensor IR, single-pole Датчик движения PIR, однофункциональный		





Lampka CHICAGO z portem USB  
Bed lamp with USB CHICAGO  
Гибкая лампа с USB-разъемом CHICAGO

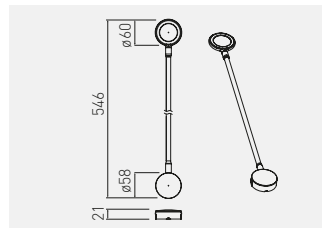

Wymaga zasilacza 12 V, 30 W  
Requires 12 V, 30 W power supply  
Требуется блок питания 12 В, 30 Вт

LD-CHIC16NE-10	120 lm	● 4000 K	biały / white / белый	stal, tworzywo steel, plastic сталь, пластмасса
LD-CHIC16NE-20			czarny / black / черный	



Lampka BOSTON  
Lamp BOSTON  
Лампа BOSTON

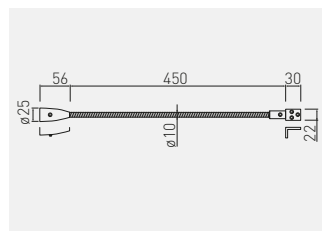







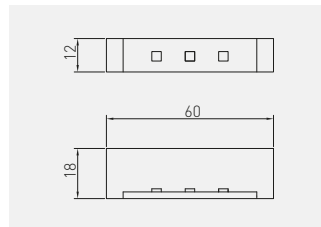

Wymaga zasilacza 12 V, 6 W  
Requires 12 V, 6 W power supply  
Требуется блок питания 12 В, 6 Вт

LD-BOS1CBWG-53	90 lm	● 3000 K	aluminium	stal, aluminium, tworzywo steel, aluminium, plastic сталь, алюминий, пластмасса
LD-BOS1CBWB-53			aluminium алюминий	



Klip plastikowy LED do półek  
Plastic LED clip for shelves  
Пластиковая клипса LED для стеклянных полок







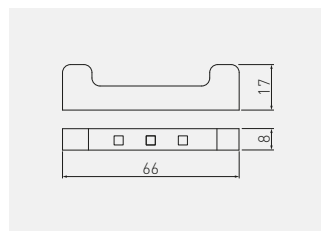

			
LD-KLPCB-00N	10 lm	 3200 K	tworzywo plastic пластик
LD-KLPNB-00N		 4000 K	
LD-KLPZB-00N		 6200 K	



Klip metalowy LED do półek  
Metal LED clip for shelves  
Металлическая клипса LED для стеклянных полок



			
LD-3SKL-CBN	10 lm	 3200 K	stal steel сталь
LD-3SKL-NBN		 4000 K	
LD-3SKL-ZBN		 6200 K	



Oprowa punktowa wpuszczana  
 Recessed spot fixture  
 Точечный светильник, врезной

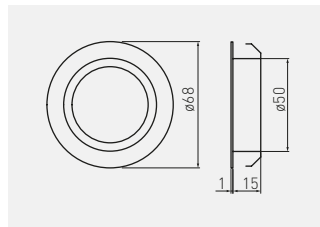

OM-OPW000-60	max.20 W	złoto / gold / золото	stal steel
OM-OPW000-61		stare złoto / antique gold / старое золото	stal steel



Zestaw opraw halogenowych  
 Halide lamp fixture set  
 Комплект галогенных светильников

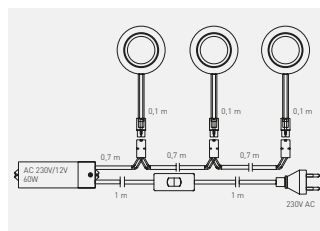

OM-ZH3200-60	max.3x20 W	złoto / gold / золото	stal, tworzywo / steel, plastic / сталь, пластмасса



## Zestaw opraw halogenowych Halide lamp fixture set Комплект галогенных светильников

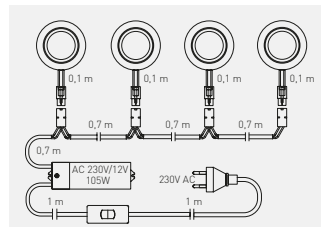

OM-ZH4200-53	max.5x20 W	aluminium / aluminium / алюминий	stal, tworzywo steel, plastic сталь, пластмасса
OM-ZH4200-51		stal szcztokowana / brushed steel / шлифованная сталь	
OM-ZH4200-60		zloty / gold / золото	



## Zestaw opraw halogenowych Halide lamp fixture set Комплект галогенных светильников

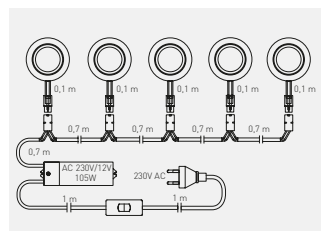

OM-ZH5200-53	max.5x20 W	aluminium / aluminium / алюминий	stal, tworzywo steel, plastic сталь, пластмасса
OM-ZH5200-51		stal szcztokowana / brushed steel / шлифованная сталь	
OM-ZH5200-60		zloty / gold / золото	







Zasilacz LED

Power supply

Блок питания для светодиодных светильников

			
LD-ZAS06W-30N	max 6 W	tworzywo plastic пластик	
LD-ZAS12W-30N	max 12 W		
LD-ZAS15W-30N	max 15 W		
LD-ZAS30W-30N	max 30 W		
LD-ZAS50W-30N	max 50 W		
LD-ZAS75W-30	max 75 W		

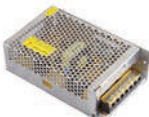

			
LD-ZAS150-NW	max 150 W	aluminium aluminium алюминий	
LD-ZAS350-NW	max 350 W		



Zasilacz LED puszkowy  
LED power supply  
Светодиодный трансформаторLED

NEW

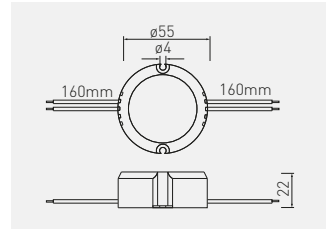

LD-ZASPU15W-30N

15 W

tworzywo / plastic / пластик



Układ zasilający LED SLIM, super cienkie  
 LED SLIM power supply set, ultra-thin  
 Блок питания LED SLIM, сверхтонкий

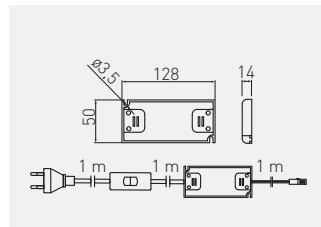

LD-SZA06W-MA	6 W	tworzywo / plastic / пластик
LD-SZA15W-MA	15 W	
LD-SZA30W-MA	30 W	
LD-SZA50W-MA	50 W	



Układ zasilający LED SLIM  
 LED SLIM slim power supply set  
 Блок питания LED SLIM

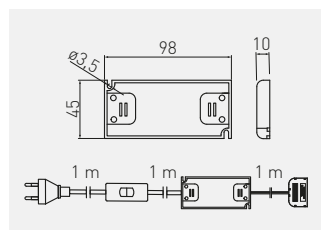

LD-SZA06W-24	6 W	tworzywo / plastic / пластик
LD-SZA15W-24	15 W	



Układ zasilający do klipów LED 5-punktowy  
 Power supply set for 5 LED clips  
 Блок питания для светодиодных клипс, 5 разъёмов

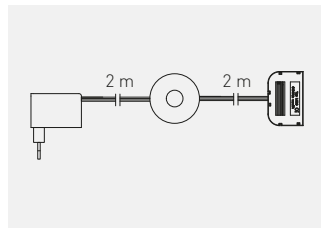

LD-ZSKL15-00

tworzywo / plastic / пластик



Układ zasilający  
 Power supply set  
 Блок питания

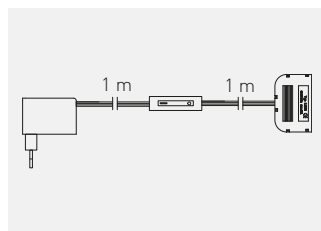

LD-ZWND6W-10

max 6 W

tworzywo / plastic / пластик

LD-ZWND12-10



max 12 W



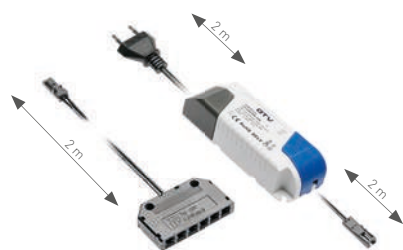

Układ zasilający z przewodami bez włącznika i dystrybutorem 6x mini amp  
 Power supply without switch, with 6x mini AMP distributor  
 Блок питания с проводами и дистрибьютором 6х мини амр, без выключателя



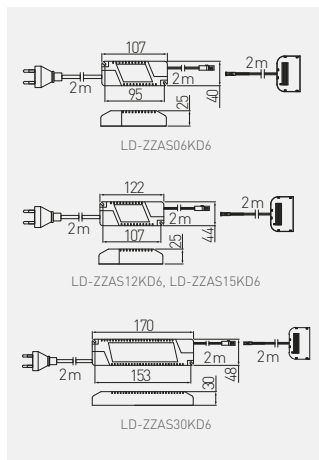

			
LD-ZZAS06KD6	6 W	tworzywo / plastic / пластик	
LD-ZZAS12KD6	12 W		
LD-ZZAS15KD6	15 W		
LD-ZZAS30KD6	30 W		

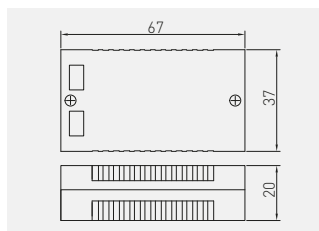

Transformator elektroniczny do żarówek halogenowych  
 Electronic power supply for halogen lamp  
 Электронный трансформатор для галогенной лампы



			
TE-500000-30	max 50W	tworzywo / plastic / пластик	



Transformator elektroniczny do żarówek halogenowych  
 Electronic power supply for halogen lamp  
 Электронный трансформатор для галогенной лампы

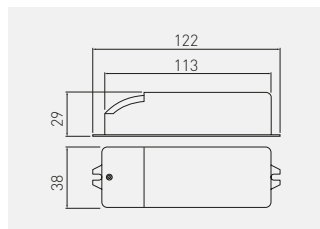



		
TE-600000-30	max 60 W	tworzywo / plastic / пластик
TE-150000-30	max 150 W	
TE-200000-30	max 200 W	

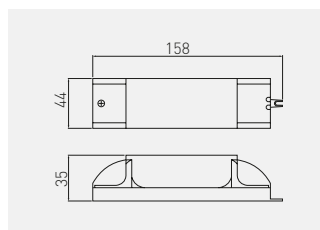

Transformator elektroniczny do żarówek halogenowych  
 Electronic power supply for halogen lamp  
 Электронный трансформатор для галогенной лампы



		
TE-150	max 150 W	tworzywo / plastic / пластик



Kontroler RGB mini z pilotem  
Mini RGB controller with remote  
Миниконтроллер RGB с пультом

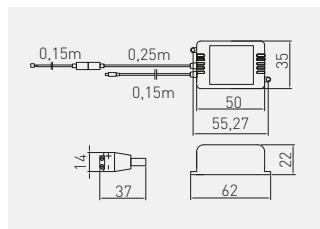

LD-KONMINI-RGB	RGB	tworzywo / plastic / пластик



Kontroler RGB z pilotem  
RGB controller with remote  
RGB контроллер с пультом

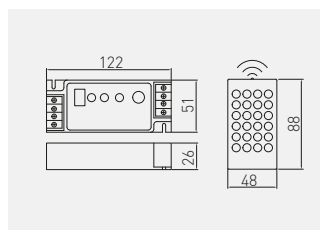

LD-KONRGB-00	RGB	tworzywo / plastic / пластик



Zestaw RGB - kontroler, zasilacz LED 6W, pilot i dystrybutor  
 RGB kit - RGB controller, power supply, remote and distributor  
 Комплект RGB – контролер, трансформатор 6W, пульт, дистрибьютор

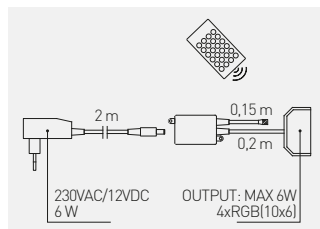

LD-ZAC6WDE-RGB	RGB	tworzywo / plastic / пластик



Zestaw RGB, taśma LED 5 m, kontroler, zasilacz, pilot  
 RGB-set, LED band 5 m, RGB controller, LED-transformator, pilot  
 Комплект RGB, лента LED 5 м, контролер, трансформатор, пульт

NEW

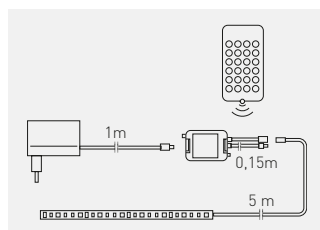

LD-ZL5RGB150-00	RGB	tworzywo / plastic / пластик



Ładowarka indukcyjna z zasilaczem  
 Wireless charger with power supply  
 Беспроводное зарядное устройство с блоком питания

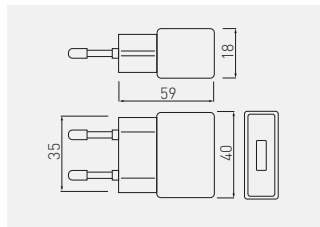

AE-ZUSB-20	czarny black черный	tworzywo plastic пластмасса



Ładowarka indukcyjna  
 Wireless charger  
 Беспроводное зарядное устройство

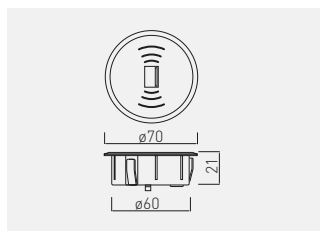

AE-USBCH-20	czarny black черный	tworzywo plastic пластмасса



Włącznik bezdotykowy  
Touchless switch  
Бесконтактный датчик

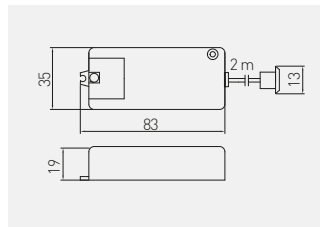

AE-WBEZDC-10S	dwubiegowy two-pole двухфункциональный	tworzywo plastic пластик
AE-WBEZDB-10S	jednobiegowy single-pole однофункциональный	



Włącznik bezdotykowy uniwersalny 3 w 1  
3 in 1 all-purpose touchless switch  
Бесконтактный выключатель 3 в 1

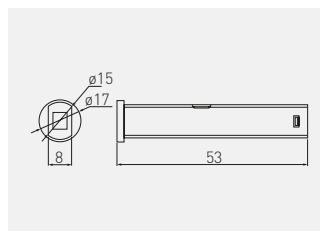

AE-WBBUNI-10DIM	biały / white / белый	tworzywo plastic пластик
AE-WBCUNI-10DIM	czarny / black / чёрный	



Włącznik dotykowy ściemniający  
Dimmable touch switch  
Выключатель с регулятором яркости

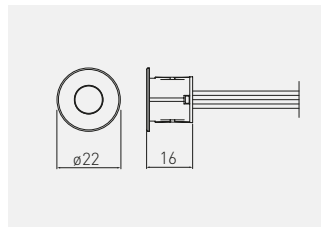

		
AE-WDSB-10DIM	biały / white / белый	tworzywo plastic пластик
AE-WDSC-10DIM	czarny / black / черный	



Włącznik dotykowy ściemniający  
Dimmable touch switch  
Выключатель с регулятором яркости

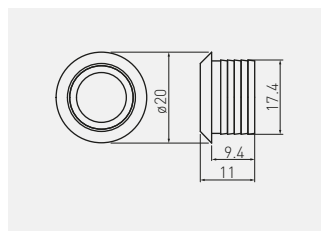

		
AE-WBEZD-NB	chrom chrome хром	tworzywo plastic пластик



## Włącznik podblatowy Countertop switch Выключатель под столешницу

Grubość blatu max 40 mm  
Countertop thickness max 40 mm  
Толщина столешницы макс. 40 мм

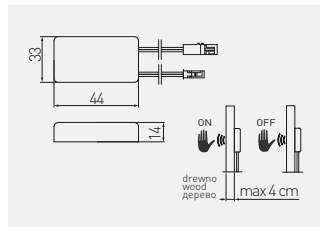

	
AE-WPDRW-00	tworzywo / plastic / пластик



## Włącznik do taśm led montowany w profil Switch for LED strips mounted in profile Выключатель для ленты LED

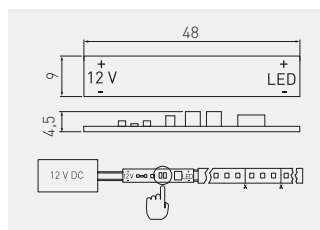

			
AE-WLPR-60	-	biały white белый	płytkę elektroniczną circuit board электронная плата
AE-WLPR-60P2	2 m		





Włącznik kotykowski  
Switch  
Выключатель кнопочный

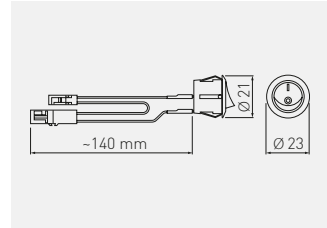



		
AE-WLB01-10	biały / white / белый	tworzywo plastic пластик
AE-WLC01-20	czarny / black / черный	

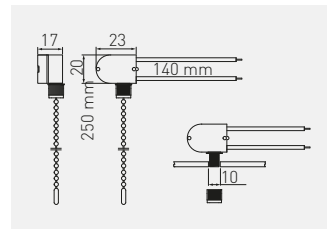

Włącznik łańcuszkowy  
Pull chain switch  
Выключатель для бра и торшеров с цепочкой



		
AE-WLLAN1-10	chrom chrome хром	



Kabel zasilający 2 m z wtyczką i włącznikiem  
 Cable 2 m with plug & switch  
 Кабель 2 м с вилкой и выключателем

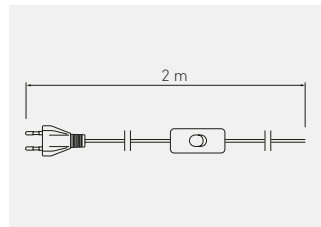

LD-KABE2M-00

biały / white / белый

tworzywo / plastic / пластик



Przewód ze złączkami mini AMP  
 Cable with Mini AMP  
 Кабель с соединителями мини-AMP

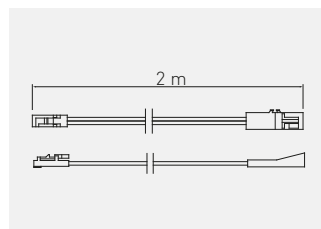

LZ-KAPR2M-10

czarny / black / черный

tworzywo / plastic / пластик



## Złączka do oświetlenia ledowego z dystrybutorem, 3 gniazda LED lamp connector with distributor, 3 sockets Соединитель LED с распределителем, 3 гнезда

Dystrybutor 3 gniazda z 2 m kablem i złączka Mini AMP  
Connector with 3 sockets, 2 m long cable and mini AMP  
Распределитель 3 гнезда, кабель 2 м, разъем Mini AMP

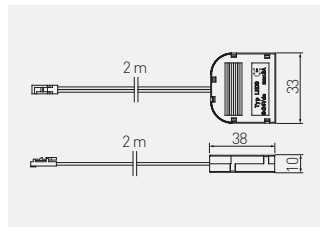

LZ-AKZ312-10N

czarny / black / черный

tworzywo / plastic / пластик



## Złączka do oświetlenia ledowego z dystrybutorem, 6 gniazd LED lamp connector with distributor, 6 sockets Соединитель LED с распределителем, 6 гнезд

Dystrybutor 6 gniazd z 2 m kablem i złączka Mini AMP  
Connector with 6 sockets, 2 m long cable and mini AMP  
Распределитель 6 гнезд, кабель 2 м, разъем Mini AMP

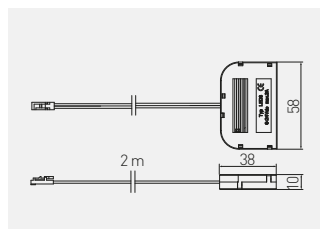

LZ-AKZ612-10N

czarny / black / черный

tworzywo / plastic / пластик



## Złączka XC11 do taśm LED Connector XC11 for LED strips Соединитель XC11 для лент LED



LD-ZTL8MM-02N



LD-ZTL8MM-02N600



LD-ZTL10MM-02N



LD-ZTLRGB-04N

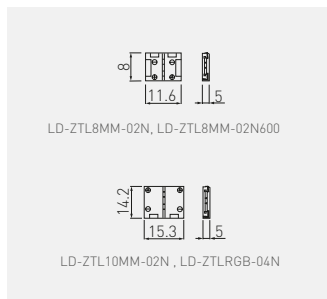

LD-ZTL8MM-02N	8 mm	tworzywo plastic пластик
LD-ZTL8MM-02N600	8 mm / 600 LED	
LD-ZTL10MM-02N	10 mm	
LD-ZTLRGB-04N	RGB	



## Złączka XC11 kątowa do taśm LED Angular connector XC11 for LED strips Угловой соединитель XC11 для лент LED



LD-ZTKT8MM-02N



LD-ZTKT8MM-02N600



LD-ZTKT10MM-02N



LD-ZTKTRGB-02N

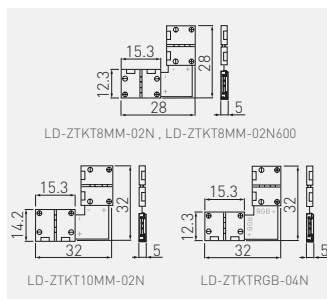

LD-ZTKT8MM-02N	8 mm	tworzywo plastic пластик
LD-ZTKT8MM-02N600	8 mm / 600 LED	
LD-ZTKT10MM-02N	10 mm	
LD-ZTKTRGB-04N	RGB	



Złączka XC11 do taśm LED z przewodem 15 cm  
 Connector XC11 with 15 cm cord, for strips  
 Соединитель XC11 для лент LED, с проводом 15 см



LD-ZTK8MM-02N LD-ZTK8MM-02N600 LD-ZTK10MM-02N

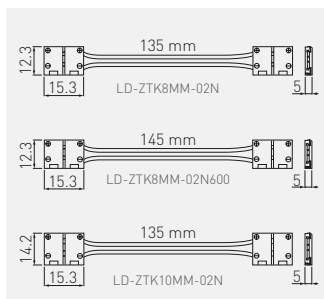

LD-ZTK8MM-02N	8 mm	tworzywo plastic пластик
LD-ZTK8MM-02N600	8 mm / 600 LED	
LD-ZTK10MM-02N	10 mm	



Złączka XC11 do taśm LED z przewodem 2 m  
 Connector XC11 with 2 m cord, for LED strips  
 Соединитель XC11 для лент LED, с проводом 2 м

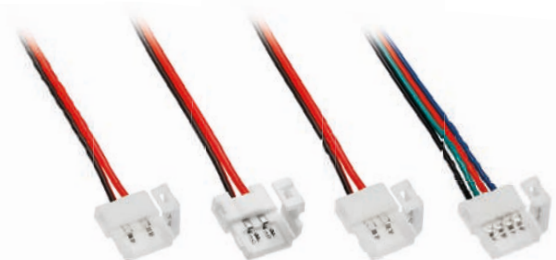

LD-ZTL82M-2N LD-ZTL82M-2N600 LD-ZTL102M-2N LD-ZTLRGB2M-4N

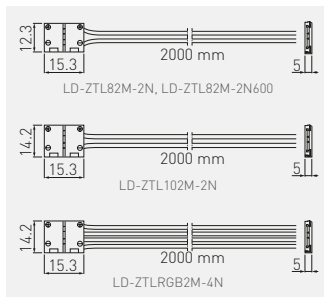

LD-ZTL82M-2N	8 mm	tworzywo plastic пластик
LD-ZTL82M-2N600	8 mm / 600 LED	
LD-ZTL102M-2N	10 mm	
LD-ZTLRGB2M-4N	RGB	



Złączka XC11 do taśm LED z przewodem 2 m i mini amp  
 Connector XC11 with 2 m cord and mini AMP, for LED strips  
 Соединитель XC11 для лент LED, с проводом 2 м и мини amp

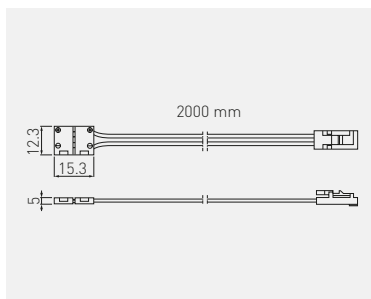

LD-ZTL8MMAMP-02N	8 mm	tworzywo / plastic / пластик
LD-ZTL8MMAMP-02N600	8 mm / 600 LED	



Przedłużacz biurkowy wpuszczany okrągły ELITE  
 Pull-out power socket - round ELITE  
 Выдвижной настольный удлинитель, круглый ELITE

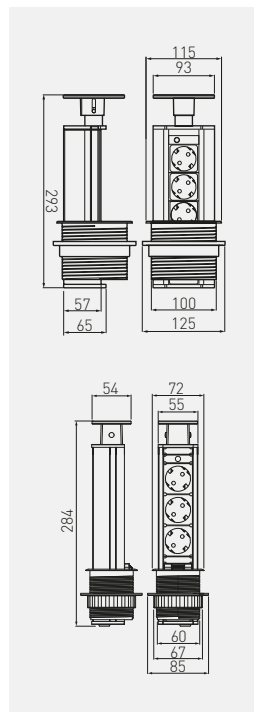

AE-BPWE3GS-00	100	schuko	-	srebrny silver серебристый	aluminium, tworzywo aluminium, plastic алюминий, пластмасса	
AE-BPWE3GU-00		french	-			
AE-BPWE3S60-00	60	schuko	-			
AE-BPWE3S60U-00			5V USB			
AE-BPWE3U60-00		french	-			
AE-BPWE3U60U-00			5V USB			



Pokrywa i pierścień do przedłużaczy ELITE  
 Cap and ring for pull-out power socket ELITE  
 Крышка для удлинителя ELITE

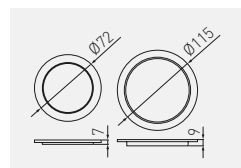

AE-CAP100-40	100	chrom / chrome / хром		stal steel сталь
AE-CAP100-51		stal szorstkowana / brushed steel / шлифованная сталь		
AE-CAP60-40	60	chrom / chrome / хром		
AE-CAP60-51		stal szorstkowana / brushed steel / шлифованная сталь		

Przedłużacz biurkowy wpuszczany okrągły  $\varnothing$  60  
 Pull-out power socket - round  $\varnothing$  60  
 Выдвижной настольный удлинитель, круглый  $\varnothing$  60



AE-BPW3U60-20



AE-BPW3U60-80







AE-BPW3U60U-20

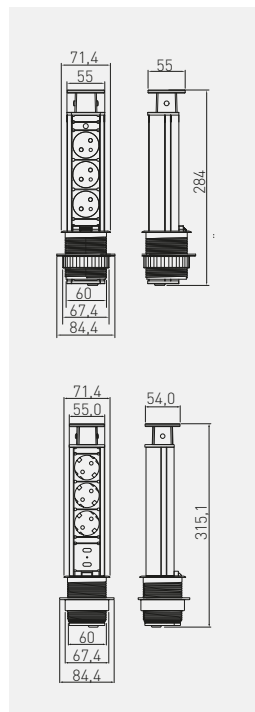

AE-BPW3U60U-80



					
AE-BPW3U60-20	french	-	-	czarny / black / черный	aluminium, tworzywo aluminium, plastic алюминий, пластмасса
AE-BPW3U60-80				srebrny / silver / серебристый	
AE-BPW3S60-20	schuko	-	-	czarny / black / черный	
AE-BPW3S60-80				srebrny / silver / серебристый	
AE-BPW3U60U-20	french	-	5V USB	czarny / black / черный	
AE-BPW3U60U-80				srebrny / silver / серебристый	
AE-BPW3S60U-20	schuko	-	5V USB	czarny / black / черный	
AE-BPW3S60U-80				srebrny / silver / серебристый	





Przedłużacz biurkowy wpuszczany okrągły  $\varnothing$  100  
 Pull-out power socket - round  $\varnothing$  100  
 Выдвижной настольный удлинитель, круглый  $\varnothing$  100



AE-BPW3GU-80

AE-BPW3GU-20

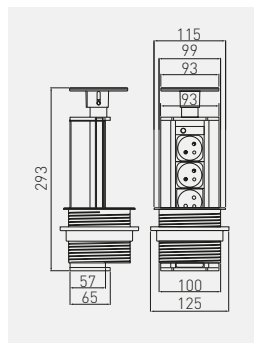

		mm			
AE-BPW3GU-20	100	french	czarny / black / черный	aluminium, tworzywo aluminium, plastic алюминий, пластмасса	
AE-BPW3GU-80			srebrny / silver / серебристый		
AE-BPW3GS-20		schuko	czarny / black / черный		
AE-BPW3GS-80			srebrny / silver / серебристый		



Przedłużacz biurkowy wpuszczany prostokątny  
 Rectangular pop-up power and connection socket  
 Настольный удлинитель, прямоугольный, врезной



AE-PB02GS-53

AE-PBC2GU-53

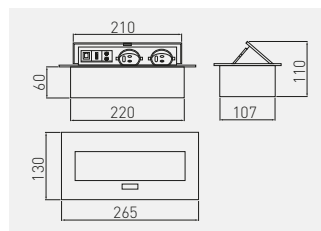

			mm		
AE-PB02GS-53	schuko	-	aluminium aluminium алюминий	stal, tworzywo steel, plastic сталь, пластмасса	
AE-PB02GU-53	french	-			
AE-PBC2GU-53	french	1,5 m			



Przedłużacz biurkowy wpuszczany prostokątny  
 Rectangular pop-up power and connection socket  
 Настольный удлинитель, прямоугольный, врезной

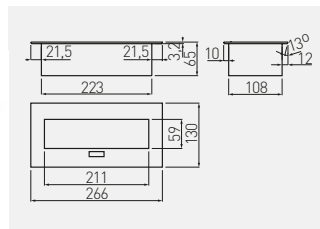

AE-PB03GS-53	schuko	-	aluminium aluminium алюминий	stal, tworzywo steel, plastic сталь, пластмасса
AE-PB03GU-53	french	-		
AE-PBC3GU-53	french	1,5 m	czarny / black / черный	
AE-PBC3GU-20	french	1,5 m		
AE-PBC3GU-10	french	1,5 m	biały / white / белый	



Przedłużacz biurkowy wpuszczany prostokątny  
 Rectangular pop-up power and connection socket  
 Настольный удлинитель, прямоугольный, врезной

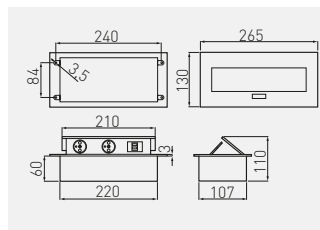

AE-PBU2GU-10	french	biały / white / белый	stal, tworzywo steel, plastic сталь, пластмасса	
AE-PBU2GU-20	schuko	czarny / black / черный		



Przedłużacz biurkowy kątowy  
 Corner power socket  
 Настольный удлинитель, угловой

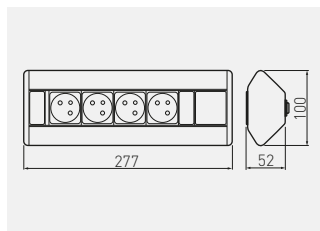

AE-PBKT4U-80	french	-	srebrny silver серебристый	aluminium, tworzywo aluminium, plastic алюминий, пластмасса	
AE-PBKT4S-80	schuko				
AE-PBKT3U2U-80	french	5V USB			
AE-PBKT3S2U-80	schuko				



Przedłużacz biurkowy MULTI  
 Power socket MULTI  
 Настольный удлинитель MULTI

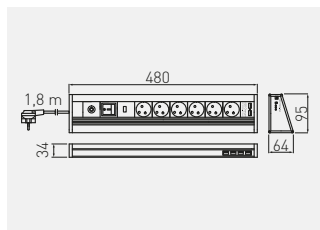

AE-PBMUL6U6U-53	french	aluminium aluminium алюминий	aluminium, tworzywo aluminium, plastic алюминий, пластмасса	
AE-PBMUL6S6U-53	schuko			



Przedłużacz biurkowy wpuszczany CHARGER  
 Desk recessed power socket CHARGER  
 Настольный удлинитель, встраиваемый CHARGER



AE-BPW1S2UCH-80

AE-BPW1U2UCH-80

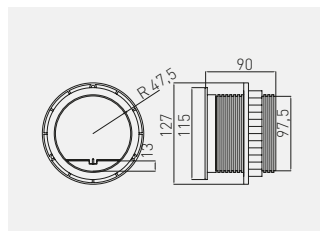

AE-BPW1S2UCH-80	100	schuko	srebrny silver	tworzywo plastic пластмасса
AE-BPW1U2UCH-80		french	серебристый	



Przedłużacz biurkowy bez kasety  
 Through-desk power socket without housing  
 Настольный удлинитель без корпуса



AE-PBC3GS-51BK

AE-PBC3GU-51BK

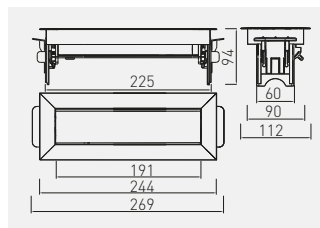

AE-PBC3GS-51BK	schuko	stal szczotkowana brushed steel	stal, aluminium, tworzywo steel, aluminium, plastic сталь, алюминий, пластмасса
AE-PBC3GU-51BK	french	шлифованная сталь	



Przedłużacz biurkowy przepustowy  
Through-desk power socket letterbox brush cable access  
Настольный удлинитель с пропуском под кабель



AE-PBC3GS-53BKS

AE-PBC3GS2U-53BKS

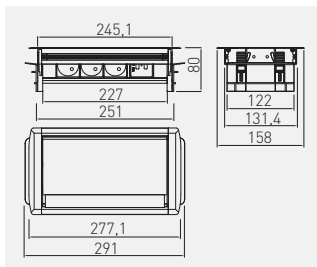

AE-PBC3GS-53BKS	schuko	-	aluminium aluminium алюминий	aluminium, tworzywo aluminium, plastic алюминий, пластика
AE-PBC3GU-53BKS	french	-		
AE-PBC3GS2U-53BKS	schuko	USB		
AE-PBC3GU2U-53BKS	french	USB		



Przedłużacz biurkowy przepustowy z HDMI  
Through-desk power socket letterbox brush cable access  
Настольный удлинитель с пропуском под кабель

NEW



AE-PBC2GS1HDMI-53BKS



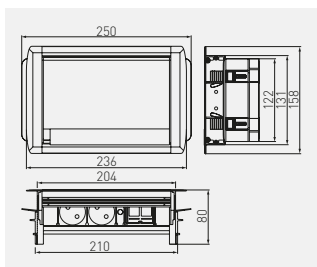





















AE-PBC2GU1HDMI-53BKS



AE-PBC2GS1HDMI-53BKS	schuko	1 x HDMI	aluminium aluminium алюминий	aluminium, tworzywo aluminium, plastic алюминий, пластика
AE-PBC2GU1HDMI-53BKS	french			



IKONY OBJAŚNIENIA / ICONS EXPLANATION / ОПИСАНИЕ ИКОНОК

	indeks index индекс		wymiary (mm) dimensions (mm) размеры (мм)		odległość cięcia odległość cięcia длина отрезка
	wysokość prowadnika guide height высота чашки		wymiary (m) dimensions (m) размеры (м)		szerokość taśmy szerokość taśmy ширина ленты
	wkręty zwykłe wood screws саморезы		grubość size толщина		USB USB USB
	euro wkręty euro screws евро саморезы		szerokość zewnętrzna szafki outside width of the cabinet наружная ширина ящика		rodzaj gniazda rodzaj gniazda тип гнезда
	pokrycie finish покрытие		materiał material материал		moc power номинальный режим
	kolor color цвет		wysuw extension выдвижение	<div data-bbox="739 558 890 638" style="border: 1px solid gray; padding: 5px;">                     Akcesoria meblowe Furniture accessories Мебельная фурнитура                 </div>	
	obciążenie load нагрузка		kształt shape форма		
	pojemność capacity емкостельность		strumień świetlny luminous flux номинальный световой поток		zawias nakładany overlay door накладная петля
	siła oporu strenght сила опоры		długość przewodu wire length длина провода		zawias bliźniaczy twin overlay полунакладная петля
	długość length длина		ilość diód number of diodes количество диод		zawias wpuszczany inset door вкладная петля
	rozstaw size межцентровое расстояние		kolor obudowy housing color цвет корпуса		zawias kątowy corner hinge угловая петля
	wysokość height высота		temperatura barwowa światła color temperature температура оттенка света		zawias o szerokim kącie otwarcia wide angle hinge петля с широким углом открывания
	strata wysuwu extension loss потеря Выдвижения		kąt świecenia beam angle угол свечения		zawias równoległy parallel hinge петля под фальшпанель (равнолежащая)
	średnica diameter диаметр		dodatkowe informacje additional information дополнительная информация		zawias równoległy nakładany Parallel hinge for overlay door петля накладная под фальшпанель
	szerokość width ширина		stopień ochrony IP stopień ochrony IP степень защиты IP		zawias uzupełniający Complementary hinge Петля для складных дверей
					regulacja adjustment регулировка



działanie jednostopniowe  
single action hinge  
одношаговая петля



zawias samootwierający  
self-opening hinge  
петля самооткрывающаяся



szuflada standard  
standard drawer  
стандартный ящик



działanie dwustopniowe  
double action hinge  
двухшаговая петля



zawias bez sprężyny  
hinge without spring  
петля без пружины



szuflada zlewozmywakowa  
under sink drawer  
ящик под мойку



zawias do zastosowań specjalnych  
special hinge  
петля для специальных конструкций



cichy domyk  
quiet shut  
бесшумное закрывание



szuflada narożna  
corner drawer  
ящик угловой



średnica puszki  
hinge cup diameter  
диаметр чашки



szuflada niska  
low drawer  
низкий ящик



szuflada standardowa  
standard drawer  
стандартный ящик



rozstaw otworów puszek  
hinge cup drilling spacing  
межцентровое расстояние  
отверстий на чашке



szuflada średnia  
medium drawer  
средний ящик



szuflada wewnętrzna  
inner drawer  
внутренний ящик



montaż puszek na wkręty do drewna  
Wood screw hinge cup mounting  
монтаж чашки на саморезы  
по дереву



szuflada wysoka  
high drawer  
высокий ящик



przewodnica dolnego montażu  
under mount drawer  
направляющая нижнего монтажа



montaż przewodnika na wkręty do drewna  
Wood screw mounting plate installation  
установка ответной планки  
на саморезы по дереву



regulacja pion i poziom  
vertical and horizontal adjustment  
регулировка по ширине и высоте



przewodnica kulkowa  
ball-bearing slide  
шариковая направляющая



montaż przewodnika na wkręty euro  
Euro screw mounting plate installation  
установка ответной планки на евровинты



opcja wypięcia  
release option  
снятие ящика без инструментов



przewodnica rolkowa  
roller slide  
роликовая направляющая



montaż przewodnika na kolki  
dowel mount hinge  
монтаж чашки на саморезы с дюбелями



wysokość boku MB Square  
drawer side height MB Square  
высота боковой стенки MB Square



metalbox  
metalbox  
металбок



regulacja mimośrodowa  
Eccentric adjustment  
эксцентриковая регулировка



wysokość boku MB  
drawer side height MB  
высота боковой стенки MB



cichy domyk  
quiet shut  
бесшумное закрывание



x 100  
pakowanie  
packing  
упаковка



wysokość boku AXIS  
drawer side height AXIS  
высота боковой стенки AXIS



samodociąg  
self closing  
доводчик



sposób montażu clip-on  
clip-on mounting  
быстрый монтаж clip-on



dostępna bryła 3D  
3D model available  
есть 3D модель



montaż nasuwany ze sprzęgłem  
push mounting with locking device  
надвижной монтаж с креплением фасада



sposób montażu slide-on  
slide-on mounting  
надвижной монтаж slide-on



trwałość  
tested durability  
Кол-во циклов откр./закр.



montaż nakładany  
put on mounting  
накладной монтаж



zawias z mechanizmem cichego domyku  
hinge with soft closing  
петля с доводчиком Soft Close



Push-to-Open



częściowy wysuw  
partial extension  
неполное выдвижение



zawias ze sprężyną dociągającą  
hinge with closing spring  
петля с прижимной пружиной



pełny wysuw  
full extension  
полное выдвижение



max grubość płyty  
max board thickness  
макс. толщина плиты



regulacja pionowa  
vertical adjustment  
регулировка по ширине



regulacja pozioma  
horizontal adjustment  
регулировка по высоте



regulacja głębokości  
depth adjustment  
регулировка по глубине



zastosowanie do szkła  
appliance glass  
применение к стеклу



zastosowanie do szkła 4 mm  
appliance glass 4 mm  
применение к стеклу 4 мм



zastosowanie do płyty  
appliance panel  
применение к плите



zastosowanie do płyty 18 mm  
appliance panel 18 mm  
применение к плите 18 мм



zastosowanie do płyty 12 mm  
appliance panel 12 mm  
применение к плите 12 мм



zastosowanie do płyty 16 mm  
appliance panel 16 mm  
применение к плите 16 мм



zastosowanie do płyty 10 mm  
appliance panel 10 mm  
применение к плите 10 мм



zastosowanie do płyty ≥ 16 mm  
appliance panel ≥ 16 mm  
применение к плите ≥ 16 мм



zastosowanie do płyty 16 - 22 mm  
appliance panel 16 - 22 mm  
применение к плите 16 - 22 мм



zastosowanie do płyty 16 - 28 mm  
appliance panel 16 - 28 mm  
применение к плите 16 - 28 мм

## Oświetlenie meblowe Furniture lighting Мебельное освещение



klasa energetyczna  
energy efficiency class  
класс энергоэффективности



zasilanie napięciem przemiennym 220-240 V  
220-240 V power supply ac  
напряжение питания 220-240 В переменный ток



zasilanie napięciem stałym 12 V  
12 V power supply DC  
напряжение питания 12 В постоянный ток



zasilanie napięciem 12 V  
12 V power supply  
напряжение питания 12 В



napięcie wyjściowe  
output voltage  
напряжение на выходе



moc źródła światła lub urządzenia  
light bulb or fixture power  
мощность лампы или устройства



maksymalne dopuszczalne obciążenie  
max permissible load  
максимально допустимая нагрузка



kąt świecenia  
beam angle  
угол свечения



rodzaj diody  
types of diode  
тип диодов



ilość diód  
number of diodes  
количество диодов



długość przewodu  
wire length  
длина провода



długość przewodu z wtyczką  
length of cord with plug  
длина провода с вилкой



długość przewodu ze złączką  
length of cord with connector  
длина провода с соединителем



rodzaj złączki  
type of connector  
тип соединителя



	rodzaj złączeni type of connector тип соединителя		temperatura pracy working temperature рабочая температура
	rodzaj złączeni type of connector тип соединителя		gniazdo USB USB port USB-порт
	stopień ochrony ip international protection marking пылевлагозащита ip		maksymalne obciążenie gniazd USB max load USB ports максимальная нагрузка портов USB
	współczynnik oddawania barw colour rendering index индекс цветопередачи		gniazdo UK UK socket гнездо UK
	współczynnik mocy power factor коэффициент мощности		ethernet ethernet port ethernet - порт
	liczb cykli wł/wył switching cycle количество циклов вкл./выкл.		nie współpracuje ze ściemniaczami non-dimmable нет возможности подключения диммера
	włącznik dotykowy ściemniający dimmable touch switch выключатель с регулятором яркости		współpracuje ze ściemniaczami dimmable есть возможность подключения диммера
	oprawa z włącznikiem fixture with switch светильник с выключателем		montaż na ścianie / suficie application: indoor / ceiling mounted монтаж на стене / потолке
	sterowanie pilotem IR remote control IR управление с помощью пульта ИК		rekomenowana odległość montażu od powierzchni recommended mounting distance from surfaces рекомендуется монтаж устройства на расстоянии
	włącznik bezdotykowy dwubiegunowy two-pole touchless switch бесконтактный переключатель / двухфункциональный		średnica otworu montażowego mounting hole diameter монтажное отверстие диаметром
	włącznik do szafy / jednobiegunowy single-pole touchless switch переключатель для шкафов / однофункциональный		akumulator battery аккумулятор
	zasięg czujki ruchu range of motion sensor площадь действия сенсора		
	czas pracy nominal lifetime время работы		
	czas włączania starting time (max) время включения		
	trzonek źródła światła G4 base type G4 тип цоколя G4		

KOLORY POKRYĆ  
FINISH COLORS  
ЦВЕТ ПОКРЫТИЯ



antyczny mosiądz  
szcztokowany  
antique brushed brass  
античная шлифованная  
латунь



mleczny  
milk  
молочный



chrom  
chrome  
хром



biały  
white  
белый



ocynk  
zink - plated  
оцинковка



satyna  
satin  
сатин



biały mat  
white matt  
белый матовый



brąz  
brown  
коричневый



mosiądz  
brass  
латунь



tytan szcztokowany  
brushed titanium  
шлифованный титан



jasny brąz  
light brown  
светло-коричневый



antyczny mosiądz  
antique brass  
античная латунь



czarny chrom  
black chrome  
чёрный хром



ciemny brąz  
dark brown  
темно-коричневый



aluminium  
aluminium  
алюминий



tytan  
titanium  
титан



calvados  
calvados  
кальвадос



stal szcztokowana  
brushed steel  
шлифованная сталь



czarny  
black  
чёрный



szary  
gray  
серый



antyczne srebro  
antique silver  
античное серебро



antyczna miedz  
antique cooper  
Античная медь



srebrny  
silver  
серебристый



kadm  
cadmium  
кадмий



czarny mat  
black matt  
чёрный матовый



zielony  
green  
зеленый



wenge  
wenge  
венге



dąb jasny  
bright oak  
светлый дуб



pomarańczowy  
orange  
оранжевый



mahoń  
mahogany  
красное дерево



dąb mleczny  
frosted oak  
молочный дуб



niebieski  
blue  
синий



ciemny mahoń  
dark mahogany  
темное красное дерево



klon różowy  
pink maple  
розовый клен



różowy  
pink  
розовый



grusza  
pear  
груша



klon żółty  
yellow maple  
желтый клен



kremowy  
ecru  
экрю



olcha  
alder  
ольха



legno jasne  
legno bright  
legno светлый



kość słoniowa  
ivory  
слоновая кость



legno ciemne  
legno dark  
legno темный

KOLORY OKLEIN  
VENEER COLORS  
ЦВЕТ ШПОНА



jasny orzech  
bright walnut  
светлый орех



redwood  
redwood  
красно-коричневый



beż  
beige  
кремовый



ciemny orzech  
dark walnut  
темный орех



wiśnia  
cherry  
вишня





buk  
beech  
бук

**Klasa ochronności na pył, ciała stałe i wodę**  
**Dust, solids & water ingress protection rating**  
**Класс защиты от пыли, твердых тел и воды**

IP	Stopień ochrony I Protection rating I Степень защиты I
0	Brak ochrony None Отсутствие защиты
1	Ochrona przed ciałami obcymi statymi o wielkości ponad 50 mm. Protection against ingress of > 50 mm bodies. Защита от попадания инородных твердых тел размером более 50 мм.
2	Ochrona przed ciałami statymi przekraczającymi 12 mm. Protection against ingress of > 12 mm bodies. Защита от попадания инородных твердых тел размером более 12 мм.
3	Ochrona przed ciałami statymi przekraczającymi 2,5 mm. Protection against ingress of > 2.5 mm bodies. Защита от попадания инородных твердых тел размером более 2,5 мм.
4	Ochrona przed ciałami statymi przekraczającymi 1 mm. Protection against ingress of > 1 mm bodies. Защита от попадания инородных твердых тел размером более 1 мм.
5	Pyłoodporność Protection against ingress of dust Пылестойкость
6	Pyłoszczelność Dustproof Пылестойкость

IP	Stopień ochrony II Protection rating II Степень защиты II
0	Brak ochrony None Отсутствие защиты
1	Ochrona przed pionowo wpadającymi kroplami wody. Protection against dripping water (vertically falling drops). Защита от вертикально падающих капель воды.
2	Ochrona przed kroplami wody przy przechyleniu do 15°. Protection against dripping water when tilted up to 15°. Защита от капель воды, падающих под углом до 15°.
3	Ochrona przed rozpyloną wodą Protection against spraying water. Защита от распыленной воды.
4	Ochrona przed bryzgami wody Protection against splashing of water. Защита от брызг воды.
5	Ochrona przed strugami wody Protection against water jets Защита от струй воды
6	Ochrona przed falami Protection against powerful water jets (waves) Защита от волн
7	Ochrona przed zanurzeniem Protection against immersion Защита от погружения
8	Ochrona przed głębokim zanurzeniem Protection against deep immersion Защита от глубокого погружения

**Klasa ochronności przed porażeniem elektrycznym**  
**Electric shock protection class**  
**Класс защиты от поражения электрическим током**

Klasa bezpieczeństwa Safety class Класс безопасности	Symbol Symbol Символ	Wyjaśnienie Definition Пояснение
<p style="text-align: center;"><b>0</b></p>	<p style="text-align: center;">Brak None Нет Keine Nincs</p>	<p>Ochronę przed porażeniem elektrycznym stanowi izolacja podstawowa. W przypadku uszkodzenia izolacji ochronę przeciwporażeniową powinny zapewnić odpowiednio korzystne warunki środowiskowe oraz położenie urządzenia poza dotykiem bezpośrednim.</p> <p>The protection against electric shock relies on basic insulation only. In the event of insulation failure, electric shock protection shall be assured by suitably favourable environmental conditions and locating the equipment beyond the reach of direct touch.</p> <p>Защиту от поражения электрическим током обеспечивает основная изоляция. В случае повреждения изоляции защиту от поражения электрическим током должны обеспечить соответствующие благоприятные условия окружающей среды и размещение оборудования вне зоны прямого контакта.</p>
<p style="text-align: center;"><b>I</b></p>		<p>W urządzeniach z I klasą ochronności bezpieczeństwo zapewnione jest przez połączenie wszystkich czynnych przewodzących elementów z przewodem ochronnym lub bezpośrednio z uziemieniem.</p> <p>Class I equipment provides protection by connecting all live conductive parts to a protective wire or directly to earth.</p> <p>В устройствах с I классом защиты безопасность обеспечивается посредством объединения всех действующих проводящих элементов с защитным проводом или непосредственно с заземлением.</p>
<p style="text-align: center;"><b>II</b></p>		<p>W urządzeniach z II klasą ochronności bezpieczeństwo zapewnione jest przez zastosowanie izolacji podwójnej lub wzmocnionej, której w danych warunkach środowiskowych i przy napięciu znamionowym uważa się nie do przebicia.</p> <p>Class II equipment provides protection by the use of double or strengthened insulation, which is deemed breakdown-proof under given environmental conditions at the rated voltage.</p> <p>В устройствах с II классом защиты безопасность обеспечивается путем применения двойной или усиленной изоляции, которая в данных условиях окружающей среды и при номинальном напряжении считается непробиваемой.</p>
<p style="text-align: center;"><b>III</b></p>		<p>Ochrona przeciwporażeniowa w urządzeniach z III klasy ochronności jest zapewniona przez obniżenie napięcia zasilania do wartości bezpiecznej w danych warunkach środowiskowych.</p> <p>Class III equipment protection against electric shock is provided by reduction of power voltage to a safe limit under given environmental conditions.</p> <p>Защита от поражения электрическим током в устройствах с III классом защиты обеспечивается снижением напряжения питания до безопасного в данных условиях окружающей среды значения.</p>

**Indeksy**

**A**  
 63..... 350  
 117..... 346  
 120..... 345  
 135..... 347  
 A-B43-32..... 404  
 A-B43-40..... 403  
 A-BUDP-SET..... 410  
 A-BUD-UB..... 410  
 A-BUD-UG..... 410  
 A-BUD-UM..... 410  
 A-BUD-UP..... 410  
 A-BUD-UR..... 410  
 A-C18-300-05..... 393  
 A-C18-300-05..... 407  
 A-C18-300-05..... 408  
 A-C18-300-10..... 393  
 A-C18-300-90..... 393  
 A-DPG-16..... 398  
 AE-BPW15ZUCH-80..... 478  
 AE-BPW1U2UCH-80..... 478  
 AE-BPW3G5-20..... 475  
 AE-BPW3G5-80..... 475  
 AE-BPW3GU-20..... 474  
 AE-BPW3GU-80..... 474  
 AE-BPW3S40-20..... 474  
 AE-BPW3S40-80..... 474  
 AE-BPW3U60-20..... 474  
 AE-BPW3U60-80..... 474  
 AE-BPW3U60U-20..... 474  
 AE-BPW3U60U-80..... 474  
 AE-BPW3G5-00..... 473  
 AE-BPW3G5U-00..... 473  
 AE-BPW3G5U-00..... 473  
 AE-BPW3S40U-00..... 473  
 AE-BPW3S40U-00..... 473  
 AE-BPW3S40U-00..... 473  
 AE-BPW3S40U-00..... 473  
 AE-CAP60-51..... 473  
 AE-CAP60-51..... 473  
 AE-CAP100-40..... 473  
 AE-CAP100-51..... 473  
 AE-CPB02G5-53..... 475  
 AE-CPB02GU-53..... 475  
 AE-CPB03G5-53..... 476  
 AE-CPB03GU-53..... 476  
 AE-CPB03GU-53..... 476  
 AE-PCB2G51HDMI-53BK5..... 479  
 AE-PCB2G51HDMI-53BK5..... 479  
 AE-PCB2GU-53..... 475  
 AE-PCB3G5S2U-53BK5..... 479  
 AE-PCB3G5S-51BK..... 478  
 AE-PCB3G5S-53BK5..... 479  
 AE-PCB3G5U2U-53BK5..... 479  
 AE-PCB3GU-53..... 476  
 AE-PCB3GU-53..... 476  
 AE-PCB3GU-53..... 476  
 AE-PCB3GU-53BK5..... 479  
 AE-PCB3GU-53BK5..... 479  
 AE-PCB3GU-53BK5..... 479  
 AE-PBKT3S2U-80..... 477  
 AE-PBKT3U2U-80..... 477  
 AE-PBKT4S-80..... 477  
 AE-PBKT4U-80..... 477  
 AE-PBMUL6S6U-53..... 477  
 AE-PBMUL6U6U-53..... 477  
 AE-PBU2GU-10..... 476  
 AE-PBU2GU-20..... 476  
 AE-USBCH-20..... 463  
 AE-WBBUNI-10DIM..... 464  
 AE-WBCUNI-10DIM..... 464  
 AE-WBEZDB-10S..... 464  
 AE-WBEZDC-10S..... 464  
 AE-WBEZDB-NB..... 465  
 AE-WDSB-10DIM..... 465  
 AE-WDSC-10DIM..... 465  
 AE-WLB01-10..... 467  
 AE-WLC01-20..... 467  
 AE-WLLANT1-10..... 467  
 AE-WLPR-60..... 466  
 AE-WLPR-60P2..... 466  
 AE-WPDRW-00..... 466  
 AE-ZUSB-20..... 463  
 A-H16-300-05..... 394  
 A-H16-300-90..... 394  
 A-H18-300-05..... 394  
 A-H18-300-10..... 394  
 A-H18-300-90..... 394  
 A-HR10-170-05..... 395  
 A-HR10-235-05..... 395  
 A-HR10-235-90..... 395  
 A-HR10-300-05..... 395  
 A-HR10-300-10..... 395  
 A-HR10-300-90..... 395  
 A-HR10-405-05..... 395  
 A-HR10-405-90..... 395

A-HR10-600-05..... 395  
 A-HR10-600-90..... 395  
 A-HR10FL-300-05..... 396  
 A-HR10FL-300-10..... 396  
 A-HR18-300-05..... 394  
 A-HR18-300-10..... 394  
 A-HR18-300-90..... 394  
 A-HRS10-170-05..... 396  
 A-HRS10-235-05..... 396  
 A-HRS10-300-05..... 396  
 A-HRS10-300-90..... 396  
 A-HRS10-405-05..... 396  
 A-HRS10-600-05..... 396  
 A-HRS18-170-05..... 395  
 A-HRS18-170-90..... 395  
 A-HRS18-235-05..... 395  
 A-HRS18-235-90..... 395  
 A-HRS18-300-05..... 395  
 A-HRS18-300-90..... 395  
 A-HRS18-405-05..... 395  
 A-HRS18-405-90..... 395  
 A-HRS18-600-05..... 395  
 A-HRS18-600-90..... 395  
 A-K18-300-05..... 393  
 A-K18-300-10..... 393  
 A-K18-300-90..... 393  
 A-KLP-4..... 402  
 A-KR-4..... 402  
 A-LD10-170-05..... 391  
 A-LD10-235-05..... 391  
 A-LD10-235-90..... 391  
 A-LD10-300-05..... 391  
 A-LD10-300-10..... 391  
 A-LD10-300-90..... 391  
 A-LD10-405-05..... 391  
 A-LD10-405-90..... 391  
 A-LD10-600-05..... 391  
 A-LD10-600-90..... 391  
 A-LD10FL-235-05..... 392  
 A-LD10FL-235-90..... 392  
 A-LD10FL-300-05..... 392  
 A-LD10FL-300-10..... 392  
 A-LD10FL-300-90..... 392  
 A-LD18-170-05..... 390  
 A-LD18-170-90..... 390  
 A-LD18-235-05..... 390  
 A-LD18-235-90..... 390  
 A-LD18-300-10..... 390  
 A-LD18-300-90..... 390  
 A-LD18-405-05..... 390  
 A-LD18-405-90..... 390  
 A-LD18-600-05..... 390  
 A-LD18-600-90..... 390  
 A-LG10-170-05..... 391  
 A-LG10-235-05..... 391  
 A-LG10-235-90..... 391  
 A-LG10-300-05..... 391  
 A-LG10-300-10..... 391  
 A-LG10-300-90..... 391  
 A-LG10-405-05..... 391  
 A-LG10-405-90..... 391  
 A-LG10-600-05..... 391  
 A-LG10-600-90..... 391  
 A-LG10FL-235-05..... 392  
 A-LG10FL-235-90..... 392  
 A-LG10FL-300-05..... 392  
 A-LG10FL-300-10..... 392  
 A-LG10FL-300-90..... 392  
 A-LG18-170-05..... 389  
 A-LG18-170-90..... 389  
 A-LG18-235-05..... 389  
 A-LG18-235-90..... 389  
 A-LG18-300-05..... 389  
 A-LG18-300-10..... 389  
 A-LG18-300-90..... 389  
 A-LG18-405-05..... 389  
 A-LG18-405-90..... 389  
 A-LG18-600-05..... 389  
 A-LG18-600-90..... 389  
 AM-ADAP0A-10..... 39  
 AM-ADAP0A-60..... 39  
 AM-ADAP0B-10..... 39  
 AM-ADAP0B-60..... 39  
 AM-BOCZ01-60..... 37  
 A-MEVO-170-05..... 388  
 A-MEVO-170-90..... 388  
 A-MEVO-235-05..... 388  
 A-MEVO-235-90..... 388  
 A-MEVO-300-05..... 388  
 A-MEVO-300-10A..... 388  
 A-MEVO-300-90..... 388  
 A-MEVO-405-05..... 388  
 A-MEVO-405-10..... 388  
 A-MEVO-405-90..... 388  
 A-MITO-PLUS..... 406

AM-KRZYZ-KPL..... 38  
 AM-MBSOFT-P2..... 84  
 AM-OAD-DL-GM..... 40  
 AM-OAD-DL-MG..... 40  
 AM-OAD-KR-GM..... 40  
 AM-OAD-KR-MG..... 40  
 AM-OADS-DL-GM..... 40  
 AM-OADS-DL-MG..... 40  
 AM-OADS-KR-MG..... 40  
 AM-ODB000-10..... 38  
 AM-ODB000-60..... 38  
 AM-ODB01S-60..... 38  
 AM-OWP-DL-GM..... 41  
 AM-OWP-DL-MG..... 41  
 AM-OWP-KR-GM..... 41  
 AM-OWP-KR-MG..... 41  
 AM-OWPS-DL-GM..... 41  
 AM-OWPS-DL-MG..... 41  
 AM-OWPS-KR-GM..... 41  
 AM-OWPS-KR-MG..... 41  
 AM-PLA-DLU-0..... 40  
 AM-PL-DL-MAG..... 40  
 A-MPRO-170-05..... 389  
 A-MPRO-170-90..... 389  
 A-MPRO-235-05..... 389  
 A-MPRO-235-90..... 389  
 A-MPRO-300-05..... 389  
 A-MPRO-300-90..... 389  
 A-MPRO-405-05..... 389  
 A-MPRO-405-90..... 389  
 AM-PROST-KPL..... 37  
 AMR-BP-0715..... 42  
 AMR-BP-1003..... 42  
 AMS-MPST001-OC..... 359  
 AMS-MPST002-OC..... 359  
 AMS-MPST003-OC..... 360  
 A-MSOFT-ADAPT..... 405  
 A-MSOFT-RAMA..... 404  
 AM-ZAT-A1-10..... 41  
 A-PG-18..... 397  
 A-PGR-10..... 397  
 A-PGR-10S..... 398  
 A-PGR-18..... 397  
 A-POZ-MITO..... 406  
 A-PTD..... 400  
 A-PTG-10..... 387  
 A-PWR-RC-DOC..... 405  
 A-R10ARC-270-05..... 386  
 A-R10ARCO-270-90..... 386  
 A-R10FALDA-270-05..... 386  
 A-R10FALDA-270-90..... 386  
 A-R10FL-270-10..... 385  
 A-R10FL-270-90..... 385  
 A-R10FL-270-05..... 385  
 A-R10FL-270-90..... 385  
 A-R10FORM-270-05..... 385  
 A-R10FORM-270-90..... 385  
 A-R10NOV-270-05..... 385  
 A-R10NOV-270-10..... 385  
 A-R10NOV-270-90..... 385  
 A-R10TRAF0-270-05..... 386  
 A-R10TRAF0-270-90..... 386  
 A-R16ERG-270-50..... 382  
 A-R18CARO-270-05..... 383  
 A-R18CARO-270-90..... 383  
 A-R18COTE-270-05..... 384  
 A-R18COTE-270-90..... 384  
 A-R18ERG-270-05..... 382  
 A-R18ERG-270-90..... 382  
 A-R18LOCA-305-05..... 384  
 A-R18LOCA-305-90..... 384  
 A-R18NERO-270-05..... 384  
 A-R18NERO-270-10..... 384  
 A-R18NERO-270-90..... 384  
 A-R18NOVS-270-05..... 383  
 A-R18NOVS-270-10..... 383  
 A-R18NOVS-270-90..... 383  
 A-R18VIS-270-05..... 383  
 A-R18VIS-270-90..... 383  
 A-RD-MITO..... 406  
 A-RNOV2-270-05..... 382  
 A-RNOV2-270-10..... 382  
 A-RNOV2-270-90..... 382  
 A-SG-MITO..... 406  
 A-SN-ADSET..... 407  
 A-SN-ADSET..... 408  
 A-SN-FSET..... 407  
 A-SN-HSET..... 408  
 A-SN-K19-270-05..... 407  
 A-SN-K19-270-05..... 408  
 A-SN-R19RW-270-05..... 407  
 A-SN-R19RW-270-05..... 408  
 A-SN-SDP-TJ..... 409  
 A-SN-SOFT-25..... 407  
 A-SN-SOFT-25..... 407  
 A-SN-SOFT-40..... 408  
 A-SN-SOFT-40..... 408  
 A-SN-SOFT-40..... 408  
 A-SN-TDS-405-00..... 407

A-SN-TDT-405-00..... 408  
 A-SN-TG-405-00..... 407  
 A-SN-TG-405-00..... 408  
 A-SO-48X4..... 400  
 A-SO-145X4..... 401  
 A-SO-145X4-10..... 401  
 A-SO-145X4-20..... 401  
 A-SOFT-30..... 404  
 A-SOFT-50..... 404  
 A-SP-7X12..... 401  
 A-SP-48X7..... 401  
 A-SP-48X12..... 401  
 A-T18-300-05..... 393  
 A-T18-300-10..... 393  
 A-T18-300-90..... 393  
 A-TDEVO-170-05..... 387  
 A-TDEVO-170-90..... 387  
 A-TDEVO-235-05..... 387  
 A-TDEVO-235-90..... 387  
 A-TDEVO-300-10..... 387  
 A-TDEVO-300-90..... 387  
 A-TDEVO-405-05..... 387  
 A-TDEVO-405-10..... 387  
 A-TDEVO-405-90..... 387  
 A-TDPRO-170-05..... 388  
 A-TDPRO-170-90..... 388  
 A-TDPRO-235-05..... 388  
 A-TDPRO-235-90..... 388  
 A-TDPRO-300-05..... 388  
 A-TDPRO-300-90..... 388  
 A-TDPRO-405-05..... 388  
 A-TDPRO-405-90..... 388  
 A-TDPRO-600-05..... 388  
 A-TDPRO-600-90..... 388  
 A-TG-170-05..... 387  
 A-TG-170-90..... 387  
 A-TG-235-05..... 387  
 A-TG-235-90..... 387  
 A-TG-300-05..... 387  
 A-TG-300-10..... 387  
 A-TG-300-90..... 387  
 A-TG-405-05..... 387  
 A-TG-405-10..... 387  
 A-TG-405-90..... 387  
 A-TG-600-05..... 387  
 A-TG-600-90..... 387  
 A-TG-BUD-200-00..... 410  
 A-TG-BUD-300-00..... 410  
 A-TG-BUD-400-00..... 410  
 A-TMITO-200-05..... 406  
 A-TMITO-250-00..... 406  
 A-TMITO-250-05..... 406  
 A-TMITO-300-05..... 406  
 A-USZCZ-CH4..... 402  
 A-USZCZ-CH4M..... 403  
 A-USZCZ-U4..... 403  
 A-WD-EVO..... 398  
 A-WD-PRO..... 399  
 A-WDR-EVO..... 399  
 A-WDR-PRO..... 399

**B**  
 BP-SLZIGW-10..... 351  
 BP-SLZIGW-21..... 352

**E**  
 EM-SBL060-01..... 148  
 EM-SBL100-01..... 148  
 EM-SBL150-01..... 148

**G**  
 GA-IMPER-1-02B..... 307  
 GA-IMPER-1-11..... 307  
 GA-IMPER-1-20M..... 307  
 GP-0728-J4-A-04..... 290  
 GP-0728-J4-B..... 290  
 GP-0728-J4-C-04..... 290  
 GP-0728-J4-R..... 290  
 GS-BERGA-1-01..... 277  
 GS-BERGA-1-02..... 277  
 GS-BERGA-1-05..... 277  
 GS-BERGA-1-06..... 277  
 GS-BERGA-1-10..... 277  
 GS-BERGA-1-12..... 277  
 GS-BERGA-1-20M..... 277  
 GZ-71C024-01..... 308  
 GZ-CAD032-01..... 243  
 GZ-CENTO-1-04..... 306  
 GZ-CENTO-1-07..... 306  
 GZ-CENTO-1-20M..... 306  
 GZ-CLEO-1-01..... 238  
 GZ-CLEO-1-05..... 238  
 GZ-CLEO-1-06..... 238  
 GZ-CRPA20-01..... 314  
 GZ-CRPA20-03..... 314

GZ-CRPA20-A1	314	KM-A050MM-00	369	KO-SRH45150-60-OC	185	LD-AB18CB-53	448
GZ-CRPA25-01	314	KM-A050MM-30	369	KO-SRH45200-30-10	185	LD-AB18ZB-53	448
GZ-CRPA25-03	314	KM-AH35MM-00	368	KO-SRH45200-30-OC	185	LD-AL24CB-53	439
GZ-CRPA25-A1	314	KM-AH35MM-30	368	KO-SRH45200-40-10	185	LD-AL24NE-53	439
GZ-CRPA30-01	314	KM-AH50MM-00	369	KO-SRH45200-40-OC	185	LD-AL24ZB-53	439
GZ-CRPA30-03	314	KM-AH50MM-30	369	KO-SRH45200-50-10	185	LD-AL24ZB-53	439
GZ-CRPA40-A1	314	KM-B050MM-00	369	KO-SRH45200-50-OC	185	LD-BOS1CBWB-53	451
GZ-CRPA40-03	314	KM-B050MM-30	369	KO-SRH45200-50-OC	185	LD-BOS1CBWB-53	451
GZ-CRPA40-03	314	KM-B075MM-00	370	KO-SRH45200-60-OC	185	LD-CD04CB-53	438
GZ-CRPA40-A1	314	KM-B075MM-30	370	KO-SRH45200-60-OC	185	LD-CD04ZB-53	438
GZ-CRPB20-01	314	KM-BH50MM-00	369	KO-SRPR100-30-10	186	LD-CD06ZB-53	438
GZ-CRPB20-03	314	KM-BH50MM-30	369	KO-SRPR100-30-OC	186	LD-CHIC16NE-10	451
GZ-CRPB20-A1	314	KM-BH75MM-00	370	KO-SRPR100-40-10	186	LD-CHIC16NE-20	451
GZ-CRPB25-01	314	KM-BH75MM-30	370	KO-SRPR100-40-OC	186	LD-CO20CB-53	447
GZ-CRPB25-03	314	KM-RD-35-CF	370	KO-SRPR100-50-10	186	LD-CO20ZB-53	447
GZ-CRPB25-A1	314	KM-RD-35-SF	370	KO-SRPR100-50-OC	186	LD-CS36CB-53	437
GZ-CRPP30-01	314	KM-RD-50-CF	371	KO-SRPR100-50-OC	186	LD-CS36NE-53	437
GZ-CRPP30-03	314	KM-RD-50-SF	371	KO-SRPR100-60-OC	186	LD-CS36ZB-53	437
GZ-CRPP30-A1	314	KM-RD-75-CF	371	KO-SRPR150-30-10	186	LD-CSN36CB-53	437
GZ-CRPP40-01	314	KM-RD-75-SF	371	KO-SRPR150-30-OC	186	LD-CSN36ZB-53	437
GZ-CRPP40-03	314	KO-1502B0-10	214	KO-SRPR150-40-10	186	LD-EIW90CB-CZ	448
GZ-CRPP40-A1	314	KO-1502B0-CR	214	KO-SRPR150-40-OC	186	LD-ES21CB-53	438
GZ-CRPC30-01	315	KO-1502B0-SR	214	KO-SRPR150-50-10	186	LD-ES21NE-53	438
GZ-CRPC30-A1	315	KO-1502MD-CR	215	KO-SRPR150-50-OC	186	LD-ES21ZB-53	438
GZ-CRPC40-01	315	KO-1502MD-SR	215	KO-SRPR150-60-10	186	LD-FL36CB-00	449
GZ-CRPC40-A1	315	KO-2002B0-10	214	KO-SRPR150-60-OC	186	LD-FL36ZB-00	449
GZ-FROSI-1-04	306	KO-2002B0-CR	214	KO-SRPR200-30-10	186	LD-FO120CB-40	446
GZ-FROSI-1-09	306	KO-2002B0-SR	214	KO-SRPR200-30-OC	186	LD-FO120ZB-40	446
GZ-GANZA-1-01	239	KO-2002MD-CR	215	KO-SRPR200-40-10	186	LD-IRUBS-53	450
GZ-GANZA-1-05	239	KO-2002MD-SR	215	KO-SRPR200-40-OC	186	LD-IS09CB-53	439
GZ-GANZA-1-10	239	KO-3002B0-10	214	KO-SRPR200-50-10	186	LD-IS09NE-53	439
GZ-GANZA-1-12	239	KO-3002B0-CR	214	KO-SRPR200-50-OC	186	LD-IS09ZB-53	439
GZ-HILL-1-01	240	KO-3002B0-SR	214	KO-SRPR200-60-10	186	LD-KABE2M-00	468
GZ-HILL-1-05	240	KO-3002MD-CR	215	KO-SRPR200-60-OC	186	LD-KJVCB-CB	435
GZ-HILL-1-06	240	KO-3002MD-SR	215	KO-UMC4645C	213	LD-KJVCB-ZB	435
GZ-HILL-1-12	240	KO-4002MD-CR	215	KO-UMC4845C	213	LD-KLPCB-00N	452
GZ-IMOLA-1-01	249	KO-4002MD-SR	215	KT-APRIL-1-04	295	LD-KLPNB-00N	452
GZ-IMOLA-1-02	249	KO-5002MD-CR	215	KT-WPI147-04	305	LD-KLPZ-00N	452
GZ-IMOLA-1-05	249	KO-5002MD-SR	215	KW-FS0125-01	140	LD-KONMINI-RGB	461
GZ-IMOLA-1-06	249	KO-6002MD-CR	215	KW-FS0140-01	140	LD-KONRGB-00	461
GZ-OLBIA-1-04	299	KO-6002MD-SR	215	KW-FS0335-01	140	LD-KWP27CB-53	443
GZ-OLIVA-16-01	242	KO-CMB150-PW-01	216	KW-FS0350-01	140	LD-KWP27ZB-53	443
GZ-PALER-1-07	292	KO-CMB150-PW-10	216	KW-FS0375-01	140	LD-LCG119-40	436
GZ-ROMA-1-01	249	KO-CMB150-PW-OC	216	KW-FS0425-03	141	LD-LCG119-52	436
GZ-ROMA-1-02	249	KO-CMB200-PW-01	216	KW-FS0430-03	141	LD-LCG119-53	436
GZ-ROMA-1-05	249	KO-CMB200-PW-10	216	KW-FS0440-03	141	LD-LCG119-40	442
GZ-ROMA-1-06	249	KO-CMB200-PW-OC	216	KW-FS0450-03	141	LD-LCG19-52	442
GZ-ROYAL3-110/03	302	KO-CMB300-PW-01	216	KW-FS0460-03	141	LD-LCG319-52	442
GZ-SENIOR-1-01	238	KO-CMB300-PW-10	216	KW-FS0475-03	141	LD-LC9319-53	442
GZ-SENIOR-1-05	238	KO-CMB300-PW-OC	216	KW-FS0475-10	141	LD-LU27CB-00	443
GZ-TERNI-1-01	278	KO-SRH4550-30-10	185	KW-FS0650-01	141	LD-LU27ZB-00	443
GZ-TERNI-1-02	278	KO-SRH4550-30-OC	185			LD-LU16CB-10	434
GZ-TERNI-1-05	278	KO-SRH4550-40-10	185			LD-LU16CB-20	434
GZ-TERNI-1-06	278	KO-SRH4550-40-OC	185	LB-80X160-05	229	LD-LU16CB-53	434
GZ-TERNI-1-09	278	KO-SRH4550-50-10	185	LB-80X160-20	229	LD-LU16NE-10	434
GZ-TERNI-1-10	278	KO-SRH4550-50-OC	185	LB-80X280-05	229	LD-LU16NE-20	434
GZ-TERNI-1-12	278	KO-SRH4550-60-10	185	LB-80X280-20	229	LD-LU16NE-53	434
GZ-TERNI-1-20M	277	KO-SRH4550-60-OC	185	LB-80X500-05	230	LD-LU16ZB-10	434
GZ-UDINE-1-01	277	KO-SRH35100-30-10	184	LB-80X500-20	230	LD-LU16ZB-20	434
GZ-UDINE-1-02	277	KO-SRH35100-30-OC	184	LB-K80X80-05	228	LD-LU16ZB-53	434
GZ-UDINE-1-05	277	KO-SRH35100-40-10	184	LB-K80X80-20	228	LD-LUG119-40	436
GZ-UDINE-1-06	277	KO-SRH35100-40-OC	184	LB-K80X100-05	228	LD-LUG119-52	436
GZ-UDINE-1-10M	277	KO-SRH35100-50-10	184	LB-K80X100-20	228	LD-LUG119-53	436
GZ-UDINE-1-12	277	KO-SRH35100-50-OC	184	LD-3SKL-CBN	452	LD-LUG319-40	442
GZ-UDINE-1-20M	277	KO-SRH35100-60-10	184	LD-3SKL-NBN	452	LD-LUG319-52	442
GZ-VETA-1-01	239	KO-SRH35100-60-OC	184	LD-3SKL-ZBN	452	LD-LUG319-53	442
GZ-VETA-1-05	239	KO-SRH35150-30-10	184	LD-2835-300-20-CB	414	LD-MAX60CB-40N	447
GZ-VETA-1-12	239	KO-SRH35150-30-OC	184	LD-2835-300-20-CE	414	LD-MAX60ZB-40N	447
GZ-WP1136-04	304	KO-SRH35150-40-10	184	LD-2835-300-20-NE	415	LD-NKW18CB-40	450
GZ-WP1142-04	304	KO-SRH35150-40-OC	184	LD-2835-300-20-NE	415	LD-NKW18ZB-40	450
GZ-WP1152-04	304	KO-SRH35150-50-10	184	LD-2835-300-20-ZB	415	LD-NO24CB-00	449
GZ-WP1155-01	278	KO-SRH35150-50-OC	184	LD-2835-300-20-ZB	415	LD-NO24ZB-00	449
GZ-ZH-011-01A	280	KO-SRH35150-60-10	184	LD-2835-300-65-CB	414	LD-OBP27CB-53	442
GZ-ZH-011-02A	280	KO-SRH35150-60-OC	184	LD-2835-300-65-ZB	414	LD-OBP27ZB-53	442
GZ-ZH-011-05A	280	KO-SRH35200-30-10	184	LD-3528-300-20-CB	414	LD-OJVCB-CB	435
GZ-ZH-011-06A	280	KO-SRH35200-30-OC	184	LD-3528-300-20-CB	414	LD-OJVCB-ZB	435
		KO-SRH35200-30-OC	184	LD-3528-300-20-NE	414	LD-OP408C-53	444
		KO-SRH35200-40-OC	184	LD-3528-300-20-NE	415	LD-OP456C-53	445
		KO-SRH35200-50-10	184	LD-3528-300-20-ZB	414	LD-OP608C-53	445
		KO-SRH35200-50-OC	184	LD-3528-300-20-ZB	414	LD-OP609C-53	445
		KO-SRH35200-60-10	184	LD-3528-300-20-ZB	415	LD-OP7305-51N	440
		KO-SRH35200-60-OC	184	LD-3528-300-65-CB	414	LD-OP7305-52N	440
		KO-SRH35200-60-OC	184	LD-3528-300-65-ZB	414	LD-OP7305-53N	440
		KO-SRH45100-30-10	185	LD-3528-600-20-CB	414	LD-OP7605-51N	440
		KO-SRH45100-30-OC	185	LD-3528-600-20-CE	414	LD-OP7605-52N	440
		KO-SRH45100-40-10	185	LD-3528-600-65-CB	414	LD-OP7605-53N	440
		KO-SRH45100-40-OC	185	LD-3528-600-65-ZB	414	LD-PIRUSB-53	450
		KO-SRH45100-50-10	185	LD-3528-300-20-CB	415	LD-PJVCB-CB	436
		KO-SRH45100-50-OC	185	LD-3528-300-20-ZB	415	LD-PJVCB-ZB	436
		KO-SRH45100-60-10	185	LD-3528-300-65-CB	415	LD-RA60CB-40	446
		KO-SRH45100-60-OC	185	LD-5050-300-20-CB	414	LD-RA60ZB-40	446
		KO-SRH45150-30-10	185	LD-5050-300-20-ZB	414	LD-RGB-150-20	414
		KO-SRH45150-30-OC	185	LD-5050-300-20-ZB	414	LD-RGB-150-65	414
		KO-SRH45150-40-10	185	LD-5050-300-65-CB	414	LD-SR14CB-53	445
		KO-SRH45150-40-OC	185	LD-5050-300-65-ZB	414	LD-SR16NE-53	445
		KO-SRH45150-50-10	185	LD-5630-300-20-CB	414	LD-SR16ZB-53	445
		KO-SRH45150-50-OC	185	LD-5630-300-20-ZB	414	LD-SZA06W-24	457
		KO-SRH45150-60-10	185	LD-5630-300-65-CB	414	LD-SZA06W-MA	457
						LD-SZA15W-24	457



LD-SZA15W-MA 457  
LD-SZA30W-MA 457  
LD-SZA50W-MA 457  
LD-VA24CB-10 434  
LD-VA24CB-20 434  
LD-VA24CB-53 434  
LD-VA24NE-10 434  
LD-VA24NE-20 434  
LD-VA24NE-53 434  
LD-VA24ZB-10 434  
LD-VA24ZB-20 434  
LD-VA24ZB-53 434  
LD-WL2457-53 444  
LD-Z3CSCB-53 444  
LD-Z5CSCB-53 441  
LD-Z50TCB-51 440  
LD-ZAC6WDE-RGB 462  
LD-ZAS06W-30N 455  
LD-ZAS12W-30N 455  
LD-ZAS15W-30N 455  
LD-ZAS30W-30N 455  
LD-ZAS50W-30N 455  
LD-ZAS75W-30 455  
LD-ZAS150-NW 455  
LD-ZAS350-NW 455  
LD-ZASPU15W-30N 456  
LD-ZLSRGB150-00 462  
LD-ZSKL15-00 458  
LD-ZTK8MM-02N 471  
LD-ZTK8MM-02N600 471  
LD-ZTK10MM-02N 471  
LD-ZTK8MM-02N 470  
LD-ZTKT8MM-02N 470  
LD-ZTKT10MM-02N 470  
LD-ZTKTRGB-04N 470  
LD-ZTL8MM-02N 470  
LD-ZTL8MM-02N600 470  
LD-ZTL8MMAMP-02N 472  
LD-ZTL8MMAMP-02N600 470  
LD-ZTL10MM-02N 472  
LD-ZTL82M-2N 471  
LD-ZTL82M-2N600 471  
LD-ZTL102M-2N 471  
LD-ZTLR6B2M-4N 471  
LD-ZTLR6B-04N 470  
LD-ZWN6W-10 458  
LD-ZWN12-10 458  
LD-ZAS04K06 459  
LD-ZAS12K06 459  
LD-ZAS15K06 459  
LD-ZAS30K06 459  
LMB-BOC228L-ALU 154  
LMB-BOC228P-ALU 154  
LMB-BOC238L-ALU 154  
LMB-BOC238P-ALU 154  
LMB-KAT28-ALU 155  
LMB-KAT38-ALU 156  
LMB-SU-BOC228L-ALU 155  
LMB-SU-BOC228P-ALU 155  
LMB-SU-KAT28-ALU 156  
LMB-SU-SZC228-ALU 158  
LMB-SZC228-ALU 157  
LMB-SZC238-ALU 157  
LO-00-00-001 152  
LO-00-00-003 152  
LO-M2M-00-125 147  
LO-P0-00-010 152  
LO-P0-00-030 152  
LZ-AK2312-10N 469  
LZ-AK2612-10N 469  
LZ-KAPR2M-10 468

**M**  
MA-MATA-0-00 225  
MC-J01A-12-01 130  
MC-J01A-12-06 130  
MC-J01A-16-01 130  
MC-J01A-16-06 130  
MC-J01A-19-01 130  
MC-J01A-19-06 130  
MC-J01A-25-01 130  
MC-J01A-25-06 130  
MC-J02A-25-01 131  
MC-J04A2-14-01 131  
MC-J04A2-14-06 131  
MC-J04A2-18-01 131  
MC-J04A2-18-06 131  
MC-J04A2-22-01 131  
MC-J04A2-22-06 131  
MC-J60A27-01 132  
MC-J60A27-06 132  
MC-J62-01 132  
MC-J62-06 132  
MC-J63-01 128  
MC-J63-06 128  
MC-J65-08-01 129  
MC-J65-08-05 129  
MC-J65-10-01 129

MC-J65-10-05 129  
MC-J65-12-01 129  
MC-J65-12-05 129  
MC-J123-01 129  
MC-K135-05 129  
MC-K090-AR-01 133  
MC-K091-SQ-01 133  
MC-K135-06-01 130  
MG-MENSA-010 150  
MG-MENSA-030 150  
MM-FI20X6X7-PL10 148  
MM-FI20X6X7-PL20 148  
MM-FI20X6X7-PL30 148  
MM-FI20X6X7-PL80 148  
MM-FI20X6X7-ZN 148  
MP-054350-10 79  
MP-054400-10 79  
MP-054450-10 79  
MP-054500-10 79  
MP-054500-10 79  
MP-086270-10 79  
MP-086270-80 79  
MP-086300-10 79  
MP-086300-80 79  
MP-086350-10 79  
MP-086350-80 79  
MP-086400-10 79  
MP-086450-10 79  
MP-086450-80 79  
MP-086500-10 79  
MP-086500-80 79  
MP-086550-10 79  
MP-086550-80 79  
MP-118350-10 79  
MP-118400-10 79  
MP-118450-10 79  
MP-118500-10 79  
MP-150270-10 79  
MP-150270-80 79  
MP-150300-10 79  
MP-150300-80 79  
MP-150350-10 79  
MP-150350-80 79  
MP-150400-10 79  
MP-150400-80 79  
MP-150450-80 79  
MP-150500-10 79  
MP-150500-80 79  
MP-150550-10 79  
MP-150550-80 79  
MR-R0500-001 162  
MR-RDRO-0000 159  
MR-R5025-001 162  
MR-T1824-KPL 168  
MR-TD011-01 135  
MR-TH001-01 172  
MR-TH002-L01 173  
MR-TH002-P01 173  
MR-TH004-001 167  
MR-TH005-001 166  
MR-TH009-001 170  
MR-TH010-001 170  
MR-TH011-001 169  
MR-TH016-001 167  
MR-TH018-KPL 168  
MR-TH018-L01 173  
MR-TH018-P01 173  
MR-TH019-001 174  
MR-TH019-003 175  
MR-TH024-KPL 169  
MR-TH035-KPL 171  
MR-TH048-001 175  
MR-THA12-001 165  
MR-THB12-001 165  
MR-THQ21-001 174  
MR-WP-010-01 164  
MR-WP-011-01 164  
MR-WP013-001 166  
MR-WP-14-KPL 171  
MR-WP-15-KPL 171  
MR-WP-028-01 160  
MR-WP2802-01 177  
MR-WP2804-01 178  
MR-WP2806-01 178  
MR-WP2807-01 179  
MR-WP2815-01 177  
MR-WP501-001 180  
MR-WP503-001 180  
MR-WP7002-01 163  
MR-WP7003-01 163  
MR-WP7004-01 176  
MR-WP7023-01 179  
MR-ZSL011-01 135

**N**  
NM-46R710-05 365  
NM-46R820-05 365  
NM-60R710-05 365  
NM-60R710-06 365  
NM-60R710-20 365  
NM-60R820-05 365  
NM-60R820-06 365  
NM-60R820-20 366  
NM-480X730-01 366  
NM-A60710-01 361  
NM-A60710-02 361  
NM-A60710-05 361  
NM-A60710-10 361  
NM-A60710-20 361  
NM-A60710-80 361  
NM-A60820-01 361  
NM-A60820-02 361  
NM-A60820-05 361  
NM-A60820-10 361  
NM-A61100-01 361  
NM-A61100-02 361  
NM-A61100-05 361  
NM-A61100-06 361  
NM-A61100-10 361  
NM-B103-80-01 333  
NM-B103-80-06 333  
NM-B103-100-01 333  
NM-B103-100-06 333  
NM-B103-120-01 333  
NM-B103-120-06 333  
NM-B104-100-01 340  
NM-B104-150-01 340  
NM-B104-200-01 340  
NM-B-140-060 334  
NM-B-140-080 334  
NM-B-140-100 334  
NM-B-140-120 334  
NM-B-140-150 334  
NM-B-140-180 334  
NM-B-140-200 334  
NM-BD-001-M1B 343  
NM-BD-003-01 333  
NM-BD-003-02 333  
NM-BD-003-150-01 333  
NM-BD-003-150-02 333  
NM-BD-100-01 336  
NM-BD-100-02 336  
NM-BD-100-05 336  
NM-BD-100-06 336  
NM-BD-150-01 336  
NM-BD-150-02 336  
NM-BD-712-M1 344  
NM-BD-727-100 341  
NM-BD-739-05 342  
NM-BD-762-01 337  
NM-BD-762-05 337  
NM-BD-780-M1 334  
NM-BD-780-M2 334  
NM-BD-780-M5 334  
NM-BD867-100 337  
NM-BD868-100 338  
NM-BD868-150 338  
NM-BD869-150 338  
NM-DAK27-060 342  
NM-DAK27-080 342  
NM-DAK27-100 342  
NM-DAK27-120 342  
NM-DAK27-150 342  
NM-DAP77-60 339  
NM-DAP77-100 339  
NM-DAP77-150 339  
NM-DPA20-100 355  
NM-DPA20-100W 355  
NM-DPA20-150 355  
NM-DPA20-150W 355  
NM-DPD20-100 354  
NM-F50710-01 364  
NM-F50710-06 364  
NM-F50710-10 364  
NM-F50710-20 364  
NM-F50870-01 364  
NM-F50870-06 364  
NM-F50870-10 364  
NM-F50870-20 364  
NM-G60710-01 362  
NM-G60710-02 362  
NM-G60710-03 362  
NM-G60710-05 362  
NM-G60710-06 362  
NM-G60710-20 362  
NM-G60710-50 362  
NM-G60820-01 362  
NM-G60820-05 362  
NM-G60820-06 362  
NM-G60820-20 362  
NM-G61100-01 362

NM-G61100-05 362  
NM-G61100-20 362  
NM-KL-DPA-20 355  
NM-KL-DPI-20 354  
NM-MDN926-01 349  
NM-MDN927-01 349  
NM-MDN941-01 350  
NM-MDN-DA-01 347  
NM-ML-50-75 356  
NM-ML-65-85 356  
NM-ML-85-125 357  
NM-ML-95-145 357  
NM-ML-125-195 358  
NM-ML-KL 358  
NM-MUFAWB-00 353  
NM-MUFAWB-10 353  
NM-MUFAWB-00 353  
NM-MUFAWK-00 353  
NM-MUFAWK-10 353  
NM-MUFAWK-00 353  
NM-MUFAWK-00 353  
NM-NAC-27651-06 339  
NM-NAC-27651-10 339  
NM-NAC-27651-15 339  
NM-NACK27651-06 343  
NM-NACK27651-10 343  
NM-S60710-01 363  
NM-S60710-02 363  
NM-S60710-05 363  
NM-S60820-01 363  
NM-S60820-02 363  
NM-SQ040AJD-060 340  
NM-SQ040AJD-100 340  
NM-SQA100-01 341  
NM-SQA150-01 341  
NM-STGC50-95-01 344  
NM-STGV135-100-01 345  
NM-STGV135-120-01 345  
NM-STGV135-130-01 345  
NM-STGV135-150-01 345  
NM-STOMP-120-01 346  
NM-STOMP-120-20 346  
NM-STOPKA-M6 352  
NM-STOPKSZESTK-M6 353  
NM-STPL-135-01 345  
NM-STR50-100-01 335  
NM-STR50-120-01 335  
NM-STR50-150-01 335  
NM-STR60-80-01 335  
NM-STSL170-60-01 350  
NM-WPJ22-40-01 351  
NM-XH3065-05 348  
NM-XH8273-01 348

**O**  
OC-2PV340-01 218  
OC-2PV340-01-18 218  
OC-2PV350-01 218  
OC-2PV350-01-18 218  
OC-2PV360-01 218  
OC-2PV360-01-18 218  
OC-2PV370-01 218  
OC-2PV370-01-18 218  
OC-2PV380-01 218  
OC-2PV390-01 218  
OC-2PV390-01-18 218  
OC-A0150-06 217  
OC-A0160-06 217  
OC-A0170-06 217  
OC-A0180-06 217  
OC-A0190-06 217  
OC-A0350K-06 219  
OC-A0450-06 219  
OC-A0460D-06 220  
OC-A0660-06 217  
OC-A0680-06 217  
OC-E070D-CZ 200  
OM-OBK150-20 234  
OM-OB0300-05 234  
OM-OB0350-05 234  
OM-OB0400-05 234  
OM-OPW000-60 453  
OM-OPW000-61 453  
OM-ZH3200-60 453  
OM-ZH4200-51 454  
OM-ZH4200-53 454  
OM-ZH4200-60 454  
OM-ZH5200-51 454  
OM-ZH5200-53 454  
OM-ZH5200-60 454

**P**  
PA-0242-35-50 288  
PA-0242-35-50-20M 288  
PA-0243-35-50 289  
PA-0243-35-50-20M 289  
PA-3730-35-50 153



PA-3731-35-50.....	153	PA-ZASGLAXMKNK-00.....	416	PB-AXIS-WEWMOCA1.....	117	PB-D-PANLWEW.....	101
PA-GLAX3M-AL.....	418	PA-ZASGLAXMKNK-00.....	416	PB-AXIS-WEWMOCA.....	117	PB-D-PANLWEW-10.....	90
PA-GLAX-AL.....	418	PA-ZASGLAXMKNK-00.....	416	PB-AXIS-WEWMOCB1.....	118	PB-D-PANLWEW-10.....	101
PA-GLAXDR-AL.....	426	PA-ZASGLAXMKNK-00.....	419	PB-AXIS-WEWMOCB.....	118	PB-D-PRZEG1P-10.....	106
PA-GLAXKT-AL.....	420	PA-ZASGLAXMKNK-00.....	419	PB-AXIS-WEWMOCCT1.....	118	PB-D-PRZEG1P-KW.....	106
PA-GLAXMNBW3M-AL.....	430	PA-ZASGLAXNKKTT-00.....	422	PB-D-BXSIDE5B.....	106	PB-D-PRZEG1P-KW-10.....	92
PA-GLAXMNBW3M-AL.....	431	PA-ZASGLAXNKKTT-00.....	422	PB-D-BXSIDE5B-10.....	106	PB-D-REL450-10.....	99
PA-GLAXMKN3M-AL.....	416	PA-ZAWGLAXDR-00.....	426	PB-D-BXSIDE5C.....	107	PB-D-REL500-10.....	99
PA-GLAXMKNK-AL.....	416	PB-OFPO-250.....	59	PB-D-BXSIDE5C-10.....	107	PB-D-REL550-10.....	99
PA-GLAXMKNW-AL.....	417	PB-OFPO-270.....	59	PB-D-BXSIDE50B.....	106	PB-D-REL2500.....	99
PA-GLAXMPK-AL.....	425	PB-OFPO-300.....	59	PB-D-BXSIDE50B-10.....	106	PB-D-REL3500.....	99
PA-GLAXMW-AL.....	419	PB-OFPO-350.....	59	PB-D-BXSIDE50C.....	107	PB-D-REL3500.....	99
PA-GLAXNBD2M16-AL.....	429	PB-OFPO-400.....	59	PB-D-BXSIDE50C-10.....	107	PB-D-REL5000.....	99
PA-GLAXNBD2M19-AL.....	429	PB-OFPO-450.....	59	PB-D-CONBXSID.....	105	PB-D-REL5000.....	99
PA-GLAXNBD3M16-AL.....	429	PB-OFPO-500.....	59	PB-D-CONBXSIDE-10.....	105	PB-D-RELCOV.....	104
PA-GLAXNBD3M19-AL.....	429	PB-OFPO-550.....	59	PB-D-CONREL.....	105	PB-D-RELCOV-10.....	104
PA-GLAXNBD3M-AL.....	429	PB-OFPO-600.....	59	PB-D-CONREL-10.....	105	PB-D-REL350.....	88
PA-GLAXNBDW2M16-AL.....	430	PB-0M2515-60MB.....	201	PB-D-CONREL-KW.....	92	PB-D-RELKW350-10.....	88
PA-GLAXNBDW2M19-AL.....	430	PB-0M2520-60MB.....	203	PB-D-CONREL-KW-10.....	92	PB-D-RELKW400.....	88
PA-GLAXNBDW3M16-AL.....	430	PB-0M2X34-60MB.....	204	PB-D-COR600A.....	112	PB-D-RELKW400-10.....	88
PA-GLAXNBDW3M19-AL.....	430	PB-05HX18-300-H.....	56	PB-D-COR600C.....	112	PB-D-RELKW450.....	88
PA-GLAXNBDW3M-AL.....	430	PB-05HX18-350-H.....	56	PB-D-COR650A.....	112	PB-D-RELKW450-10.....	88
PA-GLAXNBJ2M16-AL.....	427	PB-05HX18-400-H.....	56	PB-D-D2R0-01.....	93	PB-D-RELKW500-10.....	88
PA-GLAXNBJ2M19-AL.....	427	PB-05HX18-450-H.....	56	PB-D-D2R0-01.....	93	PB-D-RELKW500.....	88
PA-GLAXNBJ3M16-AL.....	427	PB-05HX18-500-H.....	56	PB-D-D2R0-01.....	99	PB-D-RELKW500-10.....	88
PA-GLAXNBJ3M19-AL.....	427	PB-05HX18-550-H.....	56	PB-D-D2R0-01.....	99	PB-D-RELKW550.....	88
PA-GLAXNBJ3M-AL.....	427	PB-05HX250-5A.....	55	PB-D-D2R0-01.....	99	PB-D-RELKW550-10.....	88
PA-GLAXNBJW2M16-AL.....	428	PB-05HX-270-A.....	55	PB-D-D2R0-01.....	99	PB-D-RELW600-10.....	88
PA-GLAXNBJW2M19-AL.....	428	PB-05HX-300-A.....	55	PB-D-D2R0-01.....	99	PB-D-RLP-1100.....	102
PA-GLAXNBJW3M16-AL.....	428	PB-05HX-300-H.....	55	PB-D-KPL68-450-80.....	111	PB-D-RLP-1100-10.....	102
PA-GLAXNBJW3M19-AL.....	428	PB-05HX-350-A.....	57	PB-D-KPL68-500-80.....	111	PB-D-S2R0-00.....	94
PA-GLAXNBJW3M-AL.....	428	PB-05HX-350-H.....	57	PB-D-KPL250A.....	97	PB-D-S2R0-00.....	108
PA-GLAXNKKT3M-AL.....	422	PB-05HX-400-A.....	55	PB-D-KPL250A1.....	97	PB-D-S2R0-01.....	94
PA-GLAXNKKT-AL.....	422	PB-05HX-400-H.....	55	PB-D-KPL250C.....	98	PB-D-S2R0-01.....	108
PA-GLAXREG1-AL.....	423	PB-05HX-450-A.....	57	PB-D-KPL250C1.....	98	PB-D-UCHWEW.....	103
PA-GLAXREG2-AL.....	423	PB-05HX-450-H.....	57	PB-D-KPL300A.....	97	PB-D-UCHWEW-10.....	103
PA-GLAXWIN-AL.....	424	PB-05HX-500-A.....	55	PB-D-KPL300A1.....	97	PB-D-ULE-500.....	113
PA-GLAXWPKT-AL.....	421	PB-05HX-500-H.....	57	PB-D-KPL300B.....	98	PB-D-W2R0-00.....	94
PA-OSMGLGLAX-00.....	418	PB-05HX-550-A.....	55	PB-D-KPL300C.....	98	PB-D-W2R0-00.....	109
PA-OSMGLGLAX-00.....	420	PB-05HX-550-H.....	55	PB-D-KPL300C1.....	98	PB-D-W2R0-01.....	94
PA-OSMGLGLAX-00.....	421	PB-05HX-600-A.....	57	PB-D-KPL350A.....	97	PB-D-W2R0-01.....	109
PA-OSMGLGLAX-00.....	422	PB-002X15-60MB.....	200	PB-D-KPL350A1.....	97	PB-D-WEWKPL350C.....	87
PA-OSMGLGLAX-00.....	423	PB-002X20-60MB.....	202	PB-D-KPL350B.....	97	PB-D-WEWKPL400C.....	87
PA-OSMGLGLAX-00.....	424	PB-3DSLIDE-250.....	54	PB-D-KPL350C.....	98	PB-D-WEWKPL450C.....	87
PA-OSMGLGLAX-00.....	426	PB-3DSLIDE-270.....	54	PB-D-KPL350C1.....	98	PB-D-WEWKPL500C.....	87
PA-OSMGLGLAX-00.....	427	PB-3DSLIDE-300.....	54	PB-D-KPL400A.....	97	PB-D-WEWKPL500C.....	87
PA-OSMGLGLAX-00.....	428	PB-3DSLIDE-350.....	54	PB-D-KPL400A1.....	97	PB-D-WEWMOCA.....	99
PA-OSMGLGLAX-00.....	429	PB-3DSLIDE-400.....	54	PB-D-KPL400B.....	98	PB-D-WEWMOCA1.....	99
PA-OSMGLGLAX3M-00.....	418	PB-3DSLIDE-450.....	54	PB-D-KPL400C.....	98	PB-D-WEWMOCA-KW.....	88
PA-OSMGLGLAX3M-00.....	420	PB-3DSLIDE-500.....	54	PB-D-KPL400C1.....	98	PB-D-WEWMOCA-KW-10.....	88
PA-OSMGLGLAX3M-00.....	422	PB-3DSLIDE-550.....	54	PB-D-KPL450A.....	97	PB-D-WEWMOCCB.....	100
PA-OSMGLGLAX3M-00.....	427	PB-45-002X20.....	198	PB-D-KPL450A1.....	97	PB-D-WEWMOCCB1.....	100
PA-OSMGLGLAX3M-00.....	428	PB-45-001X3.....	197	PB-D-KPL450B.....	98	PB-D-WEWMOCCB-KW.....	89
PA-OSMGLGLAX3M-00.....	429	PB-45-202X10.....	198	PB-D-KPL450C.....	98	PB-D-WEWMOCCB-KW-10.....	89
PA-OSMGLGLAX3M-00.....	430	PB-45-002010.....	199	PB-D-KPL450C1.....	98	PB-D-WEWMOCC.....	101
PA-OSMGLGLAXM-00.....	416	PB-45M0002520.....	197	PB-D-KPL500A.....	97	PB-D-WEWMOCC1.....	101
PA-OSMGLGLAXM-00.....	417	PB-45M2002510.....	199	PB-D-KPL500A1.....	97	PB-D-WEWMOCC-KW.....	89
PA-OSMGLGLAXM-00.....	419	PB-0202X1060MB.....	202	PB-D-KPL500B.....	98	PB-D-WEWMOCC-KW-10.....	89
PA-OSMGLGLAXM-00.....	425	PB-90114100.....	206	PB-D-KPL500C.....	98	PB-D-WEWS2KLC.....	100
PA-OSMGLGLAXM3M-00.....	416	PB-90144100PCT.....	207	PB-D-KPL500C1.....	98	PB-D-WEW52KLC-10.....	100
PA-OSMGLGLAXM3M-00.....	431	PB-909334100PCT.....	208	PB-D-KPL550A.....	97	PB-D-ZLE-450.....	113
PA-OSMGLGLAXM3M-00.....	432	PB-90954100PCT.....	208	PB-D-KPL550A1.....	97	PB-D-ZLE-500.....	113
PA-OSMGLGLAXMK-00.....	416	PB-91014100.....	205	PB-D-KPL550B.....	98	PB-D-ZNACZ-0.....	95
PA-OSMGLGLAXMK-00.....	419	PB-910224160V.....	205	PB-D-KPL550C.....	98	PB-D-ZNACZ-0.....	110
PA-OSMGLGLAXMO-00.....	416	PB-91104100B5.....	211	PB-D-KPL550C1.....	98	PB-D-ZR-00-0.....	102
PA-OSMGLGLAXMO-00.....	422	PB-91114100B5.....	211	PB-D-LIS1100.....	104	PB-D-ZR-00-10.....	102
PA-OSTRGLAX-00.....	418	PB-91164100B5.....	211	PB-D-LIS1100-10.....	104	PB-D-ZR-KW-00.....	91
PA-OSTRGLAX-00.....	418	PB-91174100B5.....	211	PB-D-LIS1100-KW.....	91	PB-D-ZR-KW-10.....	91
PA-OSTRGLAX-00.....	421	PB-91464100PCT.....	209	PB-D-LR-00-0.....	103	PB-G10HX250.....	61
PA-OSTRGLAX-00.....	422	PB-91474100PCT.....	209	PB-D-LR-00-10.....	103	PB-G10HX270.....	61
PA-OSTRGLAX-00.....	423	PB-91554160V.....	210	PB-D-MATRYCA.....	95	PB-G10HX300.....	61
PA-OSTRGLAX-00.....	424	PB-91564160V.....	210	PB-D-MATRYCA.....	95	PB-G10HX350.....	61
PA-OSTRGLAX-00.....	426	PB-91634100B5.....	211	PB-D-MATRYCA.....	110	PB-G10HX400.....	61
PA-OSTRGLAX-00.....	427	PB-91644100B5.....	211	PB-D-MBSTAB.....	111	PB-G10HX450.....	61
PA-OSTRGLAX-00.....	428	PB-AXIS-KPL450A.....	115	PB-D-MHG04.....	110	PB-G10HX500.....	61
PA-OSTRGLAX-00.....	429	PB-AXIS-KPL450A1.....	115	PB-D-MHG04-KW.....	95	PB-G10HX550.....	61
PA-OSTRGLAX3M-00.....	418	PB-AXIS-KPL450B.....	115	PB-D-N2R0-00.....	93	PB-G10HX600.....	61
PA-OSTRGLAX3M-00.....	420	PB-AXIS-KPL450B1.....	115	PB-D-N2R0-00.....	108	PB-GAPO-250.....	62
PA-OSTRGLAX3M-00.....	422	PB-AXIS-KPL450C.....	116	PB-D-N2R0-01.....	93	PB-GAPO-270.....	62
PA-OSTRGLAX3M-00.....	427	PB-AXIS-KPL450C1.....	116	PB-D-N2R0-01.....	108	PB-GAPO-300.....	62
PA-OSTRGLAX3M-00.....	428	PB-AXIS-KPL500A.....	115	PB-D-P20250A.....	97	PB-GAPO-350.....	62
PA-OSTRGLAX3M-00.....	429	PB-AXIS-KPL500A1.....	115	PB-D-P20250C.....	98	PB-GAPO-400.....	62
PA-OSTRGLAX3M-00.....	430	PB-AXIS-KPL500B.....	115	PB-D-P20300A.....	97	PB-GAPO-450.....	62
PA-OSTRGLAXM-00.....	416	PB-AXIS-KPL500B1.....	115	PB-D-P20300C.....	98	PB-GAPO-500.....	62
PA-OSTRGLAXM-00.....	417	PB-AXIS-KPL500C.....	116	PB-D-P20350A.....	97	PB-GAPO-550.....	62
PA-OSTRGLAXM-00.....	419	PB-AXIS-KPL500C1.....	116	PB-D-P20350C.....	98	PB-GAPO-600.....	62
PA-OSTRGLAXM-00.....	425	PB-AXIS-PANLWEW.....	119	PB-D-P20400A.....	97	PB-GCHX-250.....	60
PA-OSTRGLAXM3M-00.....	416	PB-AXIS-PANLWEW-10.....	119	PB-D-P20400C.....	98	PB-GCHX-270.....	60
PA-OSTRGLAXM3M-00.....	431	PB-AXIS-RELKW450.....	117	PB-D-P20450C.....	97	PB-GCHX-300.....	60
PA-OSTRGLAXM3M-00.....	432	PB-AXIS-RELKW450-10.....	117	PB-D-P20450C.....	98	PB-GCHX-350.....	60
PA-ROZGLAX-526.....	426	PB-AXIS-RELKW500.....	117	PB-D-P20500A.....	97	PB-GCHX-400.....	60
PA-USZGLAX-00N.....	424	PB-AXIS-RELKW500-10.....	117	PB-D-P20500C.....	98	PB-GCHX-450.....	60
PA-USZGLAX-00N.....	424	PB-AXIS-RP-1100.....	119	PB-D-P20505A.....	97	PB-GCHX-500.....	60
PA-ZASGLAX-00.....	418	PB-AXIS-RP-1100-10.....	119	PB-D-P20505C.....	98	PB-GCHX-550.....	60
PA-ZASGLAXDR-00.....	426	PB-AXIS-U2R0-00.....	116	PB-D-P205TAB.....	84	PB-GCHX-600.....	60
PA-ZASGLAXKT-00.....	420	PB-AXIS-U2R0-10.....	116	PB-D-PANLWEW.....	90	PB-KW-KPL250A1-50.....	86

PB-KW-KPL250B	86	PG-ST6083-10	196	PK-P-0H45-350A	67	PP-GL-A48-01	124
PB-KW-KPL250B1-50	86	PG-ST6083-20	196	PK-P-0H45-400A	67	PP-GL-B48-01	124
PB-KW-KPL250C	87	PG-ST83115-10	196	PK-P-0H45-450A	67	PP-GL-C5P-01	125
PB-KW-KPL300A	86	PK-ST8311520	196	PK-P-0H45-500A	67	PP-GL-DRF5	134
PB-KW-KPL300C	87	PK-O-000-027	76	PK-P-0H45-550A	67	PP-GL-E410-01	125
PB-KW-KPL350A	86	PK-OH27-3000	75	PK-P-0H45-600A	67	PP-GL-F46B-01	126
PB-KW-KPL350A1-50	86	PK-OH27-3500	75	PK-P-0H45-650A	67	PP-H50006-01	127
PB-KW-KPL350B	86	PK-OH27-4000	75	PK-P-0H45-700A	67	PP-HS2710-01	128
PB-KW-KPL350B1-50	86	PK-OH27-4500	75	PK-S-H45-250	66	PP-LUK-00-01	136
PB-KW-KPL350B-50	86	PK-OH27-5000	75	PK-S-H45-300	66	PP-LUK-00-02	136
PB-KW-KPL350C	87	PK-OH30-2500	74	PK-S-H45-350	66	PP-LUK-00-05	136
PB-KW-KPL350C1-50	87	PK-OH30-3000	74	PK-S-H45-400	66	PP-MP0055-01	120
PB-KW-KPL400A	86	PK-OH30-3500	74	PK-S-H45-450	66	PP-MP0055-02	120
PB-KW-KPL400A1-50	86	PK-OH30-4000	74	PK-S-H45-500	66	PP-MP0055-05	120
PB-KW-KPL400B	86	PK-OH35-2500	73	PK-S-H45-550	66	PP-MP0055-06	120
PB-KW-KPL400B1-50	86	PK-O-H35-3000	73	PK-S-H45-600	66	PP-MP0055-10	120
PB-KW-KPL400B-50	86	PK-O-H35-3500	73	PK-S-H45-650	66	PP-MP0055-20	120
PB-KW-KPL400C	87	PK-O-H35-4000	73	PK-S-H45-700	66	PP-NW09X90B	136
PB-KW-KPL400C1-50	87	PK-O-H35-4500	73	PM-LBF160-01	230	PP-NW10X100B	136
PB-KW-KPL450A	86	PK-O-H35-5000	73	PM-LBF160-02	230	PP-NW10X145B	136
PB-KW-KPL450A1-50	86	PK-O-H45-250	68	PM-LBF160-05	230	PP-NW12X120B	136
PB-KW-KPL450B	86	PK-O-H45-300	68	PM-LBF160-06	230	PP-NW14X120B	136
PB-KW-KPL450B1-50	86	PK-O-H45-350	68	PM-LBF180-01	230	PP-NW14X140B	136
PB-KW-KPL450C	87	PK-O-H45-400	68	PM-LBF180-02	230	PP-NW14X165B	136
PB-KW-KPL450C1-50	87	PK-O-H45-450	68	PM-LBF180-05	230	PP-OBUW60-05	181
PB-KW-KPL500A	86	PK-O-H45-500	68	PM-LBF180-06	230	PP-OBUW60-PW	181
PB-KW-KPL500A1-50	86	PK-O-H45-550	68	PM-NAR1003-512	143	PP-OBUW90-05	182
PB-KW-KPL500B	86	PK-O-H45-600	68	PM-NAR1003-645	143	PP-OBUW90-PW	182
PB-KW-KPL500B1-50	86	PK-O-H45-700	68	PM-NAR1003-677	143	PP-P04570-20	194
PB-KW-KPL500C	87	PK-OH17182XP	77	PM-NAR1003-680	143	PP-P80110-20	194
PB-KW-KPL500C1-50	87	PK-OH17214XP	77	PM-NAR1003-695	143	PP-PMONT0D-01	142
PB-KW-KPL550A	86	PK-OH17246XP	77	PM-NAR1003-725	143	PP-PMONT0D-01	142
PB-KW-KPL550A1-50	86	PK-OH17278XP	77	PM-NAR1003-731	143	PP-PMONT0D-07	142
PB-KW-KPL550B	86	PK-OH17310XP	77	PM-NAR1003-732	143	PP-PMONT0D-08	142
PB-KW-KPL550B-50	86	PK-OH17342XP	77	PM-NAR1003-737	143	PP-PMONT0D-11	142
PB-KW-KPL550C	87	PK-OH17406XP	77	PM-NAR1003-770	143	PP-PMONT0D-20	142
PB-KW-KPL550C1-50	87	PK-OH17438XP	77	PM-NAR1003-771	143	PP-PMONT0D-22	142
PB-M202X1060MB	203	PK-OH45250GX	70	PM-NAR1004-512	143	PP-PMONT0D-50	142
PB-M342X1760MB	204	PK-OH45250GX1	70	PM-NAR1004-645	143	PP-PMONT0D-72A	142
PP-RP-KW1100	90	PK-OH45250XP	69	PM-NAR1004-677	143	PP-PMONT0D-734	142
PP-RP-KW1100-10	90	PK-OH45300GX	70	PM-NAR1004-680	143	PP-PMONTOM-01	142
PB-S10C300HX	58	PK-OH45300GX1	71	PM-NAR1004-695	143	PP-PMONTOM-07	142
PB-S10C350HX	58	PK-OH45300XP	69	PM-NAR1004-724	143	PP-PMONTOM-08	142
PB-S10C400HX	58	PK-OH45350GX	70	PM-NAR1004-725	143	PP-PMONTOM-11	142
PB-S10C450HX	58	PK-OH45350GX1	71	PM-NAR1004-728	143	PP-PMONTOM-20	142
PB-S10C500HX	58	PK-OH45350XP	69	PM-NAR1004-731	143	PP-PMONTOM-22	142
PB-S10C550HX	58	PK-OH45400GX	70	PM-NAR1004-732	143	PP-SOL003-01	127
PB-S10C600HX	58	PK-OH45400GX1	71	PM-NAR1004-770	143	PP-SOL012-01	127
PD-ECGD1-060	52	PK-OH45400XP	69	PM-NAR1004-771	143	PP-SMART-000	135
PD-ECGD1-080	52	PK-OH45450GX	70	PM-PFMH50-10	151	PP-SP0075-01	121
PD-ECGD1-150	52	PK-OH45450GX1	71	PM-PFMH50-24	151	PP-SP0075-02	121
PD-60050-N02	45	PK-OH45450XP	69	PM-PFMH50-25	151	PP-SP0075-05	121
PD-60050-N10	44	PK-OH45500GX	70	PM-PFMH51-10	151	PP-SP0075-06	121
PD-60050-N20	44	PK-OH45500GX1	71	PM-PFMH53-10	151	PP-SPL001-01	134
PD-60060-N02	45	PK-OH45500XP	69	PM-PFMH55-25	151	PP-XS0045-01	120
PD-60060-N10	44	PK-OH45550GX	70	PM-PFMH61-10	151	PP-XS0045-02	120
PD-60060-N20	44	PK-OH45550GX1	71	PM-PFMH64-10	151	PP-XS0045-05	120
PD-60080-N02	45	PK-OH45550XP	69	PM-PFMH64-25	151	PR-0B-250-10	81
PD-60080-N10	44	PK-OH45600GX	70	PM-PFMH69-10	151	PR-0B-250-30	81
PD-60080-N20	44	PK-OH45600GX1	71	PM-PLF160-02	231	PR-0B-300-10	81
PD-60100-N02	45	PK-OH45600XP	69	PM-PLF160-05	231	PR-0B-300-30	81
PD-60100-N10	44	PK-OH45650GX	70	PM-PLF160-10	231	PR-0B-350-10	81
PD-60100-N20	44	PK-OH45650GX1	71	PM-PLF160-20	231	PR-0B-350-30	81
PD-60120-N02	45	PK-OH45650XP	69	PM-PLF160-30	231	PR-0B-400-10	81
PD-60120-N10	44	PK-OH45700GX	70	PM-PLF160-41	231	PR-0B-400-30	81
PD-60120-N20	44	PK-OH45700GX1	71	PM-PLF160-42	231	PR-0B-450-10	81
PD-60150-N02	45	PK-OH45700XP	69	PM-PLF160-43	231	PR-0B-450-30	81
PD-660160-N02	47	PK-L-H35-300	72	PM-PLF160-44	231	PR-0B-500-10	81
PD-680160-N02	47	PK-L-H35-350	72	PM-PLF160-45	231	PR-0B-500-30	81
PD-GAM50-N02	46	PK-L-H35-400	72	PM-PLF160-46	231	PR-0B-550-10	81
PD-GAM60-N02	46	PK-L-H35-450	72	PM-PLF160-47	231	PR-0B-550-30	81
PD-GAM080-N02	46	PK-L-H35-500	72	PM-PLF160-48	231	PR-0B-600-10	81
PD-GAM100-N02	46	PK-L-H35-550	72	PM-PLF160-49	231	PR-0B-600-30	81
PD-GAM120-N02	46	PK-L-H45-250	63	PM-PLF160-50	231	PR-OC-250-10	82
PD-GAM150-N02	46	PK-L-H45-250-A	64	PM-PLF160-51	231	PR-OC-300-10	82
PD-GPD01-001	48	PK-L-H45-300	63	PM-PLF160-52	231	PR-OC-350-10	82
PD-GPD02-002	48	PK-L-H45-300-A	64	PM-PLF160-58	231	PR-OC-400-10	82
PD-GPD03-005	48	PK-L-H45-300-GX	65	PP-0G6S01-01	122	PR-OC-450-10	82
PD-LIFT-LIGHT-10	43	PK-L-H45-350	63	PP-0G6S01-02	122	PR-SP-250-10	80
PD-LIFT-LIGHT-80	43	PK-L-H45-350-A	64	PP-0G6S01-05	122	PR-SP-300-10	80
PD-LIFT-MEDIUM-10	43	PK-L-H45-350-GX	65	PP-0G6S02-01	122	PR-SP-350-10	80
PD-LIFT-MEDIUM-80	43	PK-L-H45-400	63	PP-0G6S02-02	122	PR-SP-400-10	80
PD-LIFT-STRONG-10	43	PK-L-H45-400-A	64	PP-0G6S02-05	122	PR-SP-450-10	80
PD-LIFT-STRONG-80	43	PK-L-H45-400-GX	65	PP-0G6S02-06	122	PR-SP-500-10	80
PD-MDLIFT-P1-D	50	PK-L-H45-450	63	PP-0G6S03-01	123	PR-SP-550-10	80
PD-MDLIFT-P2-D	51	PK-L-H45-450-A	64	PP-0G6S03-02	123	PR-SP-600-10	80
PD-MD-ZB-01	36	PK-L-H45-450-GX	65	PP-0G6S03-05	123	PU-KEY027-20	226
PD-MD-ZB-04	36	PK-L-H45-500	63	PP-0G6S04-01	123	PU-KEY027-60	226
PD-PD000-001	49	PK-L-H45-500-A	64	PP-0G6S04-02	123	PU-KEY027-20	226
PG-AL4560-20	196	PK-L-H45-500-GX	65	PP-0G6S04-05	123	PU-KEY027-60	227
PG-AL6083-20	196	PK-L-H45-550-A	64	PP-0G6S04-06	123	PU-PKO-00-20	227
PG-AL8311520	196	PK-L-H45-550-A	64	PP-0G6S04-06	123	PU-PKO-00-60	227
PG-GA6083-10	195	PK-L-H45-550-GX	65	PP-20BUW0-05	161	PW-PC31209-00N	433
PG-GA6083-20	195	PK-L-H45-600	63	PP-DP0105-01	121	PW-PC61209-00	433
PG-GA8311520	195	PK-L-H45-600-A	64	PP-DP0105-02	121		
PG-ST4560-10	196	PK-L-H45-600-GX	65	PP-DP0105-05	121		
PG-ST4560-20	196	PK-P-0H45-300A	67	PP-DP0105-06	121		

RR-161230H01.....	161	TE 500000-30.....	459	UA-ARS320-20.....	244	UA-METRO-224-496-18-01.....	289
RR-250730H01.....	161	TE 600000-30.....	460	UA-ARS630-20.....	244	UA-METRO-224-496-18-05.....	289
RR-250830H01.....	161			UA-B0-311096.....	260	UA-METRO-256-296-18-01.....	289
RR-250930H01.....	161			UA-B0-311128.....	260	UA-METRO-256-296-18-05.....	289
RR-251030H01.....	161			UA-B0-311160.....	260	UA-METRO-256-596-18-01.....	289
RR-401230H01.....	161			UA-B0-311192.....	260	UA-METRO-256-596-18-05.....	289
RR-501030H01.....	161			UA-B0-311224.....	260	UA-METRO-320-396-18-01.....	289
RR-501230H01.....	161			UA-B0-311256.....	260	UA-METRO-320-396-18-05.....	289
RR-CH-OW-000.....	159			UA-B0-311288.....	260	UA-METRO-352-796-18-01.....	289
RS-156096-01.....	283			UA-B0-311320.....	260	UA-METRO-352-796-18-05.....	289
RS-156096-02.....	283			UA-B0-311480.....	260	UA-PAXO-32-50-05.....	287
RS-156096-05.....	283			UA-B0-337128.....	260	UA-PAXO-96-150-05.....	287
RS-156096-06.....	283			UA-B0-337160.....	260	UA-PAXO-224-250-05.....	287
RS-156096-14.....	283			UA-B0-337192.....	260	UA-PAXO-320-350-05.....	287
RS-188128-01.....	283			UA-B0-337224.....	260	UA-PAXO-3500-05.....	287
RS-188128-02.....	283			UA-B0-337256.....	260	UA-PICCO-64-05.....	264
RS-188128-05.....	283			UA-B0-337320.....	260	UA-PICCO-128-05.....	264
RS-188128-06.....	283			UA-B3109606MJ.....	260	UA-PICCO-224-05.....	264
RS-188128-14.....	283			UA-B31112801.....	260	UA-SIGMA-96-05.....	267
RS-220160-01.....	283			UA-B31112806MJ.....	260	UA-SIGMA-128-05.....	267
RS-220160-02.....	283			UA-B31116001.....	260	UA-SIGMA-160-05.....	267
RS-220160-05.....	283			UA-B31116006MJ.....	260	UA-SIGMA-192-05.....	267
RS-220160-06.....	283			UA-B31119201.....	260	UA-SIGMA-224-05.....	267
RS-220160-14.....	283			UA-B31119206MJ.....	260	UA-SIGMA-256-05.....	267
RS-272192-01.....	283			UA-B31122401.....	260	UA-SIGMA-288-05.....	267
RS-272192-02.....	283			UA-B31122406MJ.....	260	UA-SIGMA-320-05.....	267
RS-272192-05.....	283			UA-B31125601.....	260	UA-TREX-32-50-05.....	288
RS-272192-06.....	283			UA-B31125606MJ.....	260	UA-TREX-96-150-05.....	288
RS-272192-14.....	283			UA-B31132001.....	260	UA-TREX-224-250-05.....	288
RS-304224-01.....	283			UA-B31132006MJ.....	260	UA-TREX-320-350-05.....	288
RS-304224-02.....	283			UA-B33712801.....	260	UA-TREX-3500-05.....	288
RS-304224-05.....	283			UA-B33712806MJ.....	260	UA-KID-A-001.....	317
RS-304224-06.....	283			UA-B33716001.....	260	UA-KID-B-001.....	317
RS-304224-14.....	283			UA-B33716006MJ.....	260	UA-KID-C-001.....	316
RS-336256-01.....	283			UA-B33719201.....	260	UA-KID-D-001.....	316
RS-336256-02.....	283			UA-B33719206MJ.....	260	UA-KID-E-001.....	316
RS-336256-05.....	283			UA-B33722401.....	260	UA-KID-F-001.....	316
RS-336256-06.....	283			UA-B33722406MJ.....	260	UA-KID-G-001.....	316
RS-336256-14.....	283			UA-B33725601.....	260	UA-KID-I-001.....	317
RS-368288-01.....	283			UA-B33725606MJ.....	260	UA-KID-I-002.....	316
RS-368288-02.....	283			UA-B33732001.....	260	UA-KID-O-001.....	317
RS-368288-05.....	283			UA-B33732006MJ.....	260	UA-KID-P-001.....	316
RS-368288-06.....	283			UA-B33741606MJ.....	260	UA-KID-Q-001.....	316
RS-400320-01.....	283			UA-B33748001.....	260	UA-KID-S-001.....	316
RS-400320-02.....	283			UA-B33748006MJ.....	260	UA-KID-T-001.....	317
RS-400320-05.....	283			UA-BETA-96-05.....	265	UA-KID-U-001.....	316
RS-400320-14.....	283			UA-BETA-128-05.....	265	UA-KID-X-001.....	317
RS-432352-01.....	283			UA-BETA-160-05.....	265	UA-KID-Y-001.....	316
RS-432352-02.....	283			UA-BETA-192-05.....	265	UA-KID-Z-001.....	317
RS-432352-05.....	283			UA-BETA-224-05.....	265	UP-WP0728-BB.....	290
RS-432352-06.....	283			UA-BETA-256-05.....	265	UP-WP0728-BK.....	290
RS-432352-14.....	283			UA-BETA-288-05.....	265	UP-WP0728-BR.....	290
RS-464384-01.....	283			UA-BETA-320-05.....	265	UP-WP0728-EB.....	290
RS-464384-02.....	283			UA-B0-337416.....	260	UP-WP0728-EX.....	290
RS-464384-05.....	283			UA-B0-337480.....	260	UP-WP0728-BX.....	291
RS-464384-06.....	283			UA-DELTA-96-05.....	266	UP-WP0728-PA-04.....	291
RS-496416-01.....	283			UA-DELTA-128-05.....	266	UP-WP0728-PA-07.....	291
RS-496416-02.....	283			UA-DELTA-160-05.....	266	UP-WP0728-PB.....	291
RS-496416-05.....	283			UA-DELTA-192-05.....	266	UP-WP0728-PC-04.....	291
RS-496416-06.....	283			UA-DELTA-224-05.....	266	UP-WP0728-PK.....	291
RS-528448-01.....	283			UA-DELTA-256-05.....	266	UP-WP0728-PR.....	291
RS-528448-02.....	283			UA-DELTA-288-05.....	266	UP-WP0728-PX.....	291
RS-528448-05.....	283			UA-DELTA-320-05.....	266	US-C1-064-06.....	279
RS-528448-06.....	283			UA-DOPPIO192-01.....	263	US-C1-096-06.....	279
RS-560480-01.....	283			UA-DOPPIO416-01.....	263	US-C1-128-06.....	279
RS-560480-02.....	283			UA-GAMMA-96-05.....	266	US-C1-160-06.....	279
RS-560480-05.....	283			UA-GAMMA-128-05.....	266	US-C7-096-01.....	279
RS-560480-06.....	283			UA-GAMMA-160-05.....	266	US-C7-096-06.....	279
RS-592512-01.....	283			UA-GAMMA-192-05.....	266	US-C7-128-01.....	279
RS-592512-02.....	283			UA-GAMMA-224-05.....	266	US-C7-128-06.....	279
RS-592512-05.....	283			UA-GAMMA-256-05.....	266	US-C7-160-01.....	279
RS-592512-06.....	283			UA-GAMMA-288-05.....	266	US-C7-160-06.....	279
RS-624544-01.....	283			UA-GAMMA-320-05.....	266	US-C7-192-01.....	279
RS-624544-02.....	283			UA-HEXI-01.....	287	US-C7-192-06.....	279
RS-624544-05.....	283			UA-HEXI-05.....	287	US-C7-224-01.....	279
RS-624544-06.....	283			UA-HEXI-10M.....	287	US-C7-224-06.....	279
RS-SZ-400-10.....	83			UA-HEXI-20M.....	287	US-C7-256-01.....	279
RS-SZ-450-10.....	83			UA-HEXI96-01.....	287	US-C7-256-06.....	279
RS-SZ-450-80.....	83			UA-HEXI96-05.....	287	US-C7-288-01.....	279
RS-SZ-500-10.....	83			UA-HEXI96-10M.....	287	US-C7-288-06.....	279
RS-SZ-500-80.....	83			UA-HEXI96-20M.....	287	US-C7-320-01.....	279
RS-TRIES-96-06.....	282			UA-KAPPA-96-05.....	267	US-C7-320-06.....	279
RS-TRIES-128-06.....	282			UA-KAPPA-128-05.....	267	US-C7-352-01.....	279
RS-TRIES-160-06.....	282			UA-KAPPA-160-05.....	267	US-C7-352-06.....	279
RS-TRIES-192-06.....	282			UA-KAPPA-192-05.....	267	US-SK0128-06.....	258
RS-TRIES-256-06.....	282			UA-KAPPA-224-05.....	267	US-SK0160-06.....	258
RS-TRIES-320-06.....	282			UA-KAPPA-256-05.....	267	US-SK0192-06.....	258
				UA-KAPPA-288-05.....	267	US-SK0224-06.....	258
				UA-KAPPA-320-05.....	267	US-SK0256-06.....	258
				UA-LUNA20160-SN.....	263	US-SK0320-06.....	258
				UA-LUNA20192-AL.....	263	US-SK0384-06.....	258
				UA-LUNA20192-SN.....	263	US-SK0448-06.....	258
				UA-LUNA20256-AL.....	263	US-SK0480-06.....	258
				UA-LUNA20256-SN.....	263	US-SK0576-06.....	258
				UA-LUNA20320-AL.....	263	US-SK0672-06.....	258
				UA-LUNA20320-SN.....	263	US-SK0800-06.....	258
						US-SKA128-06.....	258
S B							
SA-6A0X72-60.....	366						
SZ-005-00-01.....	149						
SZ-008-00-01.....	149						
T							
TE-150.....	460						
TE-150000-30.....	460						
TE-200000-30.....	460						
U							
UA-00-313128.....	262						
UA-00-313160.....	262						
UA-00-313192.....	262						
UA-00-319096.....	262						
UA-00-319128.....	262						
UA-00-319160.....	262						
UA-00-326096.....	284						
UA-00-326128.....	284						
UA-00-337096.....	269						
UA-00-337128.....	269						
UA-00-337160.....	269						
UA-00-337192.....	269						
UA-00-337224.....	269						
UA-00-337256.....	269						
UA-00-337320.....	269						
UA-00-338128.....	269						
UA-00-340128.....	270						
UA-00-340160.....	270						
UA-00-340192.....	270						
UA-00-340224.....	270						
UA-00-340256.....	270						
UA-00-340320.....	270						
UA-00-347128.....	270						
UA-00-347160.....	270						
UA-00-347192.....	270						
UA-00-347224.....	270						
UA-00-347256.....	270						
UA-00-347320.....	270						
UA-01-326096-V1.....	284						
UA-01-326128-V1.....	284						
UA-01-326160.....	284						
UA-18-128146.....	261						
UA-18-160178.....	261						
UA-18-192210.....	261						
UA-18-224242.....	261						
UA-18-256274.....	261						
UA-18-320338.....	261						
UA-18-400418.....	261						
UA-18-416434.....	261						
UA-18-480498.....	261						
UA-A3-096128.....	259						
UA-A3-128160.....	259						
UA-A3-160192.....	259						
UA-A3-192224.....	259						
UA-A3-256288.....	259						
UA-A3-320352.....	259						
UA-A4-128-06MJ.....	259						
UA-A4-160-06MJ.....	259						
UA-A4-256-06MJ.....	259						
UA-A4-320-06MJ.....	259						
UA-A18128-01.....	261						
UA-A18128-06MJ.....	261						
UA-A18160-01.....	261						
UA-A18160-06MJ.....	261						
UA-A18192-01.....	261						
UA-A18192-06MJ.....	261						
UA-A18224-01.....	261						
UA-A18224-06MJ.....	261						
UA-A18256-01.....	261						
UA-A18256-06MJ.....	261						
UA-A18320-01.....	261						
UA-A18320-06MJ.....	261						
UA-A18400-01.....	261						
UA-A18400-06MJ.....	261						
UA-A18416-01.....	261						
UA-A18416-06MJ.....	261						
UA-A18480-01.....	261						
UA-A18480-06MJ.....	2						

UZ-SKA160-06.....	258	UZ-133128-06.....	252	UZ-AREZO-96-04.....	297	UZ-GANZA-160-10.....	239
UZ-SKA192-06.....	258	UZ-334128-06.....	252	UZ-ASTI096/128-01.....	245	UZ-GANZA160-12.....	239
UZ-U4-084-01.....	281	UZ-334160-06.....	252	UZ-ASTI192/224-01.....	245	UZ-GENUA128-01.....	271
UZ-U4-084-06.....	281	UZ-334192-06.....	252	UZ-ASTI288/320-01.....	245	UZ-GENUA128-02.....	271
UZ-U4-096-01.....	281	UZ-334256-06.....	252	UZ-AVELL-96-04.....	271	UZ-GENUA160-05.....	271
UZ-U4-096-06.....	281	UZ-334320-06.....	252	UZ-AZ-012-04.....	300	UZ-GENUA160-01.....	271
UZ-U4-128-01.....	281	UZ-335128-06.....	253	UZ-AZ-128-04.....	300	UZ-GENUA160-02.....	271
UZ-U4-128-06.....	281	UZ-335160-06.....	253	UZ-AZ-160-04.....	300	UZ-GENUA160-05.....	271
UZ-U4-160-01.....	281	UZ-335192-06.....	253	UZ-BAGIO-160-01.....	246	UZ-HILL-128-01.....	240
UZ-U4-160-06.....	281	UZ-335256-06.....	253	UZ-BAGIO-160-05.....	246	UZ-HILL-128-05.....	240
UZ-U4-192-01.....	281	UZ-336128-06.....	253	UZ-BAGIO-160-06.....	246	UZ-HILL-128-06.....	240
UZ-U4-192-06.....	281	UZ-336160-06.....	253	UZ-BAGIO-160-11.....	246	UZ-HILL-128-12.....	240
UZ-U4-320-01.....	281	UZ-336192-06.....	253	UZ-BELLA160-09.....	293	UZ-HILL-160-01.....	240
UZ-U4-320-06.....	281	UZ-336256-06.....	253	UZ-BIANC-96-01.....	312	UZ-HILL-160-05.....	240
UZ-00B224-01.....	285	UZ-336320-06.....	253	UZ-BIANC-128-01.....	312	UZ-HILL-160-06.....	240
UZ-00B224-02.....	285	UZ-336416-06.....	253	UZ-CAD128-01.....	243	UZ-HILL-160-12.....	240
UZ-00B224-05.....	285	UZ-336480-06.....	253	UZ-CAD160-01.....	243	UZ-IZIS40-01.....	310
UZ-00B224-10.....	285	UZ-605032-01.....	281	UZ-CAD160-05.....	243	UZ-IZIS40-11.....	310
UZ-00B224-20.....	285	UZ-605032-05.....	281	UZ-CAD320-01.....	243	UZ-KATAN-320-01.....	248
UZ-00B226-01.....	285	UZ-682128-06.....	254	UZ-CAD320-05.....	243	UZ-KATAN-320-12.....	248
UZ-00B226-02.....	285	UZ-682160-06.....	254	UZ-CALABRIA160-01.....	271	UZ-LATIN-96-04.....	299
UZ-00B226-05.....	285	UZ-682192-06.....	254	UZ-CALABRIA160-06.....	271	UZ-LUCCA096-01.....	312
UZ-00B226-10.....	285	UZ-682224-06.....	254	UZ-CALABRIA192-01.....	271	UZ-LUCCA128-01.....	312
UZ-00B226-20.....	285	UZ-682256-06.....	254	UZ-CALABRIA192-06.....	271	UZ-LUCCA160-01.....	312
UZ-01-096-01.....	272	UZ-682320-06.....	254	UZ-CALABRIA224-01.....	271	UZ-LUCCA192-01.....	312
UZ-01-096-02.....	272	UZ-682416-06.....	254	UZ-CALABRIA224-06.....	271	UZ-LUCCA224-01.....	312
UZ-01-096-03.....	272	UZ-682480-06.....	254	UZ-CAMAI-96-01.....	276	UZ-LUCCA256-01.....	312
UZ-01-096-05.....	272	UZ-804064-01.....	254	UZ-CAMAI-96-02.....	276	UZ-MARSA-64-07.....	301
UZ-01-128-01.....	272	UZ-819096-01.....	255	UZ-CAMAI-96-06.....	276	UZ-MARSA-64-09.....	301
UZ-01-128-02.....	272	UZ-819096-02.....	255	UZ-CAMAI-96-09.....	276	UZ-MARSA-64-10M.....	301
UZ-01-128-03.....	272	UZ-819096-05.....	255	UZ-CAMAI-96-10M.....	276	UZ-MARSA-64-11.....	301
UZ-01-128-05.....	272	UZ-819096-06.....	255	UZ-CAMAI-96-12.....	276	UZ-MARSA-64-20M.....	301
UZ-02C064-01.....	308	UZ-819096-10.....	255	UZ-CAMAI-96-20M.....	276	UZ-MONZA16-06.....	241
UZ-02C096-01.....	308	UZ-819096-12.....	255	UZ-CAMAI-128-01.....	276	UZ-MONZA16-10.....	241
UZ-02CF27-01.....	308	UZ-819096-14.....	255	UZ-CAMAI-128-02.....	276	UZ-MONZA16-20.....	241
UZ-04-096-01.....	273	UZ-819096-20.....	255	UZ-CAMAI-128-06.....	276	UZ-MONZA160-06.....	241
UZ-04-096-02.....	273	UZ-819128-01.....	255	UZ-CAMAI-128-09.....	276	UZ-MONZA160-10.....	241
UZ-04-096-03.....	273	UZ-819128-02.....	255	UZ-CAMAI-128-10M.....	276	UZ-MONZA160-20.....	241
UZ-04-096-05.....	273	UZ-819128-06.....	255	UZ-CAMAI-128-12.....	276	UZ-MONZA256-06.....	241
UZ-04-128-01.....	273	UZ-819128-10.....	255	UZ-CAMAI-128-20M.....	276	UZ-MONZA256-10.....	241
UZ-04-128-02.....	273	UZ-819128-12.....	255	UZ-CLEO-128-01.....	238	UZ-MONZA384-06.....	241
UZ-04-128-03.....	273	UZ-819128-14.....	255	UZ-CLEO-128-05.....	238	UZ-MONZA384-10.....	241
UZ-04-128-05.....	273	UZ-819128-20.....	255	UZ-CLEO-128-06.....	238	UZ-MONZA384-20.....	241
UZ-05-096-01.....	273	UZ-819160-01.....	255	UZ-CLEO-160-01.....	238	UZ-0160PR-01.....	242
UZ-05-096-02.....	273	UZ-819160-02.....	255	UZ-CLEO-160-05.....	238	UZ-192PR-01.....	242
UZ-05-096-05.....	273	UZ-819160-05.....	255	UZ-CLEO-192-01.....	238	UZ-0256PR-01.....	242
UZ-05-128-01.....	273	UZ-819160-10.....	255	UZ-CLEO-192-05.....	238	UZ-OLBIA-96-04.....	299
UZ-05-128-02.....	273	UZ-819160-12.....	255	UZ-CLEO-192-06.....	238	UZ-OLBIA-128-04.....	299
UZ-05-128-05.....	273	UZ-819160-14.....	255	UZ-COMO096-01.....	311	UZ-ORLI60-01.....	244
UZ-05-128-06.....	273	UZ-819160-16.....	255	UZ-COMO128-01.....	311	UZ-ORLI60-08.....	244
UZ-06-128-01.....	274	UZ-819160-20.....	255	UZ-COMO160-01.....	311	UZ-PADWA128-01.....	248
UZ-06-128-02.....	274	UZ-819192-01.....	255	UZ-CR0333-A1.....	309	UZ-PADWA128-06.....	248
UZ-06-128-03.....	274	UZ-819192-02.....	255	UZ-CR0333-B1.....	309	UZ-PADWA160-01.....	248
UZ-06-128-05.....	274	UZ-819192-05.....	255	UZ-CRA14-128.....	309	UZ-PADWA160-06.....	248
UZ-07-096-01.....	274	UZ-819192-06.....	255	UZ-CRA14-192.....	309	UZ-PADWA192-01.....	248
UZ-07-096-02.....	274	UZ-819192-10.....	255	UZ-CRA14-320.....	309	UZ-PADWA192-06.....	248
UZ-07-096-03.....	274	UZ-819192-12.....	255	UZ-E6-096-01.....	284	UZ-PADWA224-01.....	248
UZ-07-096-05.....	274	UZ-819192-14.....	255	UZ-E6-096-05.....	284	UZ-PADWA224-06.....	248
UZ-10-096-N04.....	293	UZ-819192-20.....	255	UZ-E6-096-06.....	284	UZ-PALER-96-07.....	292
UZ-12-096-04.....	294	UZ-819256-01.....	255	UZ-E6-128-01.....	284	UZ-PALER-128-07.....	292
UZ-13-096-01.....	275	UZ-819256-02.....	255	UZ-E6-128-05.....	284	UZ-PRATO-160-01.....	247
UZ-13-096-02.....	275	UZ-819256-05.....	255	UZ-E6-128-06.....	284	UZ-PRATO-160-05.....	247
UZ-13-096-03.....	275	UZ-819256-06.....	255	UZ-E6-160-01.....	284	UZ-PRATO-160-06.....	247
UZ-13-096-05.....	275	UZ-819256-10.....	255	UZ-E6-160-05.....	284	UZ-PRATO-320-01.....	247
UZ-14-096-01.....	276	UZ-819256-12.....	255	UZ-E6-160-06.....	284	UZ-PRATO-320-05.....	247
UZ-14-096-02.....	276	UZ-819256-14.....	255	UZ-ERIS128-01.....	310	UZ-PRATO-320-06.....	247
UZ-14-096-03.....	276	UZ-819256-20.....	255	UZ-ERIS128-11.....	310	UZ-R132-A1-01.....	286
UZ-14-096-05.....	276	UZ-819320-01.....	255	UZ-G1-128-01.....	272	UZ-R132-A1-02.....	286
UZ-14-128-01.....	276	UZ-819320-02.....	255	UZ-G1-128-05.....	272	UZ-R132-A1-06.....	286
UZ-14-128-02.....	276	UZ-819320-05.....	255	UZ-G1-128-06.....	272	UZ-R160BI-01.....	242
UZ-14-128-03.....	276	UZ-819320-06.....	255	UZ-G1-128-13.....	272	UZ-R160PR-01.....	242
UZ-14-128-05.....	276	UZ-819320-10.....	255	UZ-G1-160-01.....	272	UZ-R256BI-01.....	242
UZ-19-032-01.....	280	UZ-819320-12.....	255	UZ-G1-160-05.....	272	UZ-R256PR-01.....	242
UZ-19-032-02.....	280	UZ-819320-14.....	255	UZ-G1-160-06.....	272	UZ-RENO96-04A.....	305
UZ-19-032-06.....	280	UZ-819320-20.....	255	UZ-G1-160-13.....	272	UZ-RENG01-04A.....	305
UZ-40-032-01.....	250	UZ-870128-01.....	256	UZ-G1-192-01.....	272	UZ-RENG02-04A.....	305
UZ-40-032-02.....	250	UZ-872224-01.....	256	UZ-G1-192-05.....	272	UZ-ROS160-20.....	242
UZ-40-032-05.....	250	UZ-872224-05.....	256	UZ-G1-192-06.....	272	UZ-ROS256-20.....	242
UZ-40-032-06.....	250	UZ-872224-26.....	256	UZ-G1-192-13.....	272	UZ-ROYAL1-96-10/03.....	302
UZ-55-025-01.....	250	UZ-880016-01.....	257	UZ-G1-256-01.....	272	UZ-ROYAL2-96-10/03.....	302
UZ-55-025-05.....	250	UZ-883016-01.....	257	UZ-G1-256-05.....	272	UZ-ROYAL3-96-10/03.....	302
UZ-60-032-01.....	251	UZ-883016-02.....	257	UZ-G1-256-06.....	272	UZ-ROYAL4-96-03.....	302
UZ-60-032-02.....	251	UZ-883016-05.....	257	UZ-G1-256-13.....	272	UZ-S50-A1-01.....	286
UZ-60-032-05.....	251	UZ-883016-06.....	257	UZ-G1-320-01.....	272	UZ-S50-A1-02.....	286
UZ-60-032-06.....	251	UZ-ABIAT-128-04.....	297	UZ-G1-320-05.....	272	UZ-S50-A1-05.....	286
UZ-71C096-01.....	308	UZ-ACERA-96-04.....	298	UZ-G1-320-06.....	272	UZ-S50-A1-06.....	286
UZ-79F160-01.....	251	UZ-ACRYL-Z11160.....	241	UZ-G1-320-13.....	272	UZ-SENOR-160-01.....	238
UZ-79F160-06.....	251	UZ-ADRIN-96-04.....	298	UZ-G1-416-01.....	272	UZ-SENOR-160-05.....	238
UZ-79F192-01.....	251	UZ-AGIOS-128-01.....	240	UZ-G1-416-05.....	272	UZ-SIENNA01-01.....	311
UZ-79F192-06.....	251	UZ-AGIOS-128-05.....	240	UZ-G1-416-06.....	272	UZ-SIENNA128-01.....	311
UZ-92-128-01.....	248	UZ-ALATR-128-04.....	291	UZ-G2-160-01.....	245	UZ-SIENNA160-01.....	311
UZ-92-128-05.....	248	UZ-ALRA096-01.....	268	UZ-G2-160-06.....	245	UZ-SOLANA192-01.....	247
UZ-92-160-02.....	248	UZ-ALRA096-06.....	268	UZ-G2-224-01.....	245	UZ-SOLANA192-09.....	247
UZ-133128-01.....	252	UZ-ANZIO-96-04.....	300	UZ-G2-224-06.....	245	UZ-SOLANA192-11.....	247
UZ-133128-02.....	252	UZ-APRIL-96-04.....	295	UZ-GANZA-160-01.....	239	UZ-SOLANA320-01.....	247
UZ-133128-05.....	252	UZ-ARCH096-AEB.....	296	UZ-GANZA-160-05.....	239	UZ-SOLANA320-09.....	247

UZ-SOLANA320-11.....	247	W-CUSTOMI-80L500.....	222	WZ-K23-D1-03.....	326	ZP-BICN070ZEO.....	20
UZ-TH096128-01.....	264	W-INSERTI-L450.....	223	WZ-K23-D1-05.....	326	ZP-BICN072BEO.....	20
UZ-TH096128-02.....	264	W-INSERTI-L500.....	223	WZ-K23-D1-06.....	326	ZP-BICN072ZEO.....	20
UZ-TH096128-05.....	264	WK-C0750-01.....	150	WZ-K23-E1-01.....	326	ZP-BICN080BEO.....	19
UZ-TH096128-06.....	264	WK-CF6450-01.....	150	WZ-K23-E1-02.....	326	ZP-BICN080ZEO.....	19
UZ-TH160192-01.....	264	WK-D0310-001.....	149	WZ-K23-E1-03.....	326	ZP-BICN082BEO.....	19
UZ-TH160192-02.....	264	WK-D0313-001.....	149	WZ-K23-E1-04.....	326	ZP-BICN082ZEO.....	19
UZ-TH160192-05.....	264	WK-D0316-001.....	149	WZ-K23-E1-05.....	326	ZP-BICN090BEO.....	19
UZ-TH160192-06.....	264	WK-D0320-001.....	149	WZ-K23-E1-06.....	326	ZP-BICN090ZEO.....	19
UZ-TH288320-01.....	264	WK-D0325-001.....	149	WZ-K2201-01.....	324	ZP-BICN092BEO.....	19
UZ-TH288320-02.....	264	WK-D0330-001.....	149	WZ-K2201-06.....	324	ZP-BICN092ZEO.....	19
UZ-TH288320-05.....	264	WK-D0416-001.....	149	WZ-K2201-CS.....	324	ZP-CI90H2-ZE.....	29
UZ-TH288320-06.....	264	WK-D0420-001.....	149	WZ-K2201-CZ.....	324	ZP-CI87H0ZE.....	28
UZ-TIWL-192-01.....	246	WK-D0425-001.....	149	WZ-K2201-NB.....	324	ZP-CI88H0ZE.....	28
UZ-TIWL-192-12.....	246	WK-D0430-001.....	149	WZ-K2201-PM.....	324	ZP-CI819H0ZE.....	27
UZ-TIWL-192-13.....	246	WK-D0435-001.....	149	WZ-K2201-RZ.....	324	ZP-CIG-070ZE.....	30
UZ-TIWL-320-01.....	246	WK-D0440-001.....	149	WZ-K2201-ZL.....	324	ZP-CIG-07UZE.....	30
UZ-TIWL-320-12.....	246	WK-D0460-001.....	149	WZ-K2202-01.....	324	ZP-CIG-090ZE.....	30
UZ-TIWL-320-13.....	246	WK-D3516-001.....	149	WZ-K2202-06.....	324	ZP-CIG-09UUBE.....	30
UZ-VASTO-96-09.....	292	WK-D3520-001.....	149	WZ-K2202-CS.....	324	ZP-CIG-09UZZ.....	30
UZ-VASTO-128-09.....	292	WK-D3525-001.....	149	WZ-K2202-CZ.....	324	ZP-CIG-09UZE.....	30
UZ-VER160-01.....	243	WK-D3530-001.....	149	WZ-K2202-NB.....	324	ZP-CIG-170ZE.....	30
UZ-VER160-08.....	243	WS-QUAD-14-06.....	320	WZ-K2202-PM.....	324	ZP-CIG-17UZE.....	30
UZ-VETA-128-01.....	239	WS-ROND-14-06.....	321	WZ-K2202-RZ.....	324	ZP-CIG-190ZE.....	30
UZ-VETA-128-05.....	239	WS-SOLO-14-06.....	320	WZ-K2202-ZL.....	324	ZP-CIG-19UZE.....	30
UZ-VETA-128-12.....	239	WW-2KOS20-05.....	182	WZ-MALAG-CO-01.....	329	ZP-CIHC070ZE.....	27
UZ-VETA-160-01.....	239	WW-KOAJ03-01.....	190	WZ-MALAG-CO-05.....	329	ZP-CIHC080ZE.....	26
UZ-VETA-160-05.....	239	WW-KOAJ04-01.....	192	WZ-MALAG-CO-20.....	329	ZP-CIHC090ZE.....	26
UZ-VETA-160-12.....	239	WW-K00J03-01.....	191	WZ-ORVIE-A0-09.....	331	ZP-COCA450-BE.....	24
UZ-VETA-320-01.....	239	WW-KJ0101-01.....	189	WZ-ORVIE-B0-09.....	331	ZP-COCA450-ZE.....	24
UZ-VETA-320-05.....	239	WW-KJ0201-01.....	190	WZ-SCYLPYR-BWK.....	144	ZP-COCA7450-BE.....	24
UZ-VETA-320-12.....	239	WW-KOSZ60-01.....	183	WZ-SCYLPYR-WK.....	144	ZP-CONL07-BE.....	18
UZ-VINCE-96-04.....	295	WW-KOSZ60-PW.....	183	WZ-TOLED-A0-01.....	322	ZP-CONL07-ZE.....	18
UZ-WERON-96-04.....	294	WW-KOSZ90-01.....	183	WZ-TOLED-A0-02.....	322	ZP-CONL08-BE.....	18
UZ-WERON-96-09.....	294	WW-KOSZ90-PW.....	183	WZ-TOLED-A0-05.....	322	ZP-CONL08-ZE.....	18
UZ-WERON-96-12.....	294	WW-KRAW00-20.....	189	WZ-TOLED-A0-06.....	322	ZP-CONL09-BE.....	17
UZ-WERON-128-04.....	294	WW-PASEK0-05.....	193	WZ-TOLED-B0-01.....	322	ZP-CONL09-ZE.....	17
UZ-WERON-128-09.....	294	WW-SEO102-01.....	193	WZ-TOLED-B0-02.....	322	ZP-JUNIOR-00.....	35
UZ-WERON-128-12.....	294	WW-SPODIN-05.....	191	WZ-TOLED-B0-05.....	322	ZP-KT30H2-BE.....	20
UZ-WP1146-04.....	303	WW-WSL250-01.....	194	WZ-TOLED-B0-06.....	322	ZP-KT30H2-ZE.....	20
UZ-Z10096-01.....	275	WW-WSL300-01.....	194	WZ-TOLED-CO-01.....	323	ZP-KT45H2-BE.....	21
UZ-Z10096-02.....	275	WW-WSL350-01.....	194	WZ-TOLED-CO-02.....	323	ZP-KT45H2-ZE.....	21
UZ-Z10096-03.....	275	WW-WSL400-01.....	194	WZ-TOLED-CO-05.....	323	ZP-KT90H2-BE.....	21
UZ-Z10096-05.....	275	WW-WSL450-01.....	194	WZ-TOLED-CO-06.....	323	ZP-KT90H2-ZE.....	21
UZ-Z10128-01.....	275	WW-WSL500-01.....	194			ZP-KT135H2-BE.....	23
UZ-Z10128-02.....	275	WW-WSL000-01.....	188			ZP-KT135H2-ZE.....	23
UZ-Z10128-03.....	275	WW-WSP000-01.....	188			ZP-KT165H2ZE.....	23
UZ-Z10128-05.....	275	WW-WSP000-01.....	188			ZP-KT0270-BE.....	33
		WW-WSP060-05.....	187			ZP-KT0270-ZE.....	33
<b>W</b>		WW-WSP060-PW.....	187			ZP-KT7270-BE.....	33
W-AKC-HERBI-L450.....	224	WW-WSP090-05.....	187	ZK-GTV-12-00.....	36	ZP-KTR90H4BE.....	22
W-AKC-HERBI-L500.....	224	WW-WSP090-PW.....	187	ZC-GTV-14-00.....	36	ZP-KTR90H4ZE.....	22
W-AKC-HOLDI-L450.....	225	WW-WUBR00-01.....	192	ZK-FORCE-KPL.....	144	ZP-KTR90H6ZE.....	22
W-AKC-HOLDI-L500.....	225	WW-ZWBUT7-10.....	195	ZK-R1-KPL-10.....	145	ZP-KTKN90H0.....	22
W-AKC-KNIFI-L450.....	224	WW-ZWBUT7-20.....	195	ZK-R1-KPL-30.....	145	ZP-P07H045BE.....	25
W-AKC-KNIFI-L500.....	224	WZ-00-K24-04.....	322	ZK-R1-KPL-30.....	145	ZP-P0H045BEO.....	25
WA-MALAG-A0-01.....	328	WZ-804-20-01.....	321	ZK-R1-KPL-30.....	145	ZP-P0H045ZE.....	25
WA-MALAG-A0-02.....	328	WZ-804-20-05.....	321	ZK-R1-KPL-30.....	145	ZP-RALU42-00.....	31
WA-MALAG-A0-05.....	328	WZ-804-20-06.....	321	ZK-R1-KPL-30.....	145	ZP-RALU42-07.....	32
WA-MALAG-A0-20.....	328	WZ-A0-K23-01.....	325	ZK-R1-KPL-30.....	145	ZP-RALU42-08.....	31
WA-MALAG-B0-01.....	329	WZ-A0-K23-02.....	325	ZK-R1-KPL-30.....	145	ZP-SKR-00-80.....	35
WA-MALAG-B0-02.....	329	WZ-A0-K23-03.....	325	ZK-R1-KPL-30.....	145	ZT-HF-01-000.....	34
WA-MALAG-B0-05.....	329	WZ-A0-K23-04.....	325	ZK-R1-KPL-30.....	145	ZT-HF-01-M00.....	34
WA-MALAG-B0-20.....	329	WZ-A0-K23-05.....	325	ZK-R1-KPL-30.....	145	ZZ-16-103-01.....	375
WB-073024-01.....	137	WZ-A0-K23-20.....	325	ZK-ZAS-L0-10.....	146	ZZ-20-103-01.....	375
WB-073024-06.....	137	WZ-A0-K23-20.....	325	ZK-ZAS-L0-15.....	146	ZZ-30-103-01.....	375
WB-073025-01.....	137	WZ-A0-K24-01.....	327	ZK-ZAS-L0-32.....	146	ZZ-B0-105-01.....	374
WB-073025-06.....	137	WZ-A0-K24-02.....	327	ZK-ZAS-P0-10.....	146	ZZ-BA-SK0-01.....	378
WB-073026-01.....	138	WZ-A0-K24-03.....	327	ZK-ZAS-P0-15.....	146	ZZ-C1-288-01.....	379
WB-073026-06.....	138	WZ-A0-K24-04.....	327	ZK-ZAS-P0-32.....	146	ZZ-C5-288-01.....	379
WB-WS-12-001.....	138	WZ-A0-K24-20.....	327	ZK-ZAS-R0-10.....	145	ZZ-C6-288-01.....	379
WB-WS-12-010.....	138	WZ-B0-K23-01.....	325	ZK-ZAS-R0-30.....	145	ZZ-C8-288-01.....	379
WB-WS-12-020.....	138	WZ-B0-K23-02.....	325	ZK-ZAW-R0-32.....	145	ZZ-CF-138-01.....	373
WB-WS-12-030.....	138	WZ-B0-K23-03.....	325	ZK-ZAW-R0-32.....	145	ZZ-G0-328-01.....	378
WB-WS-12-033.....	138	WZ-B0-K23-04.....	325	ZM-CHC07ZE.....	27	ZZ-KLMASTER.....	373
WB-WS-12-060.....	138	WZ-B0-K23-05.....	325	ZM-CHC08ZE.....	26	ZZ-KM-138-01.....	372
WB-WS-18-001.....	139	WZ-B0-K24-01.....	327	ZM-CHC08ZE.....	26	ZZ-M0-201-01.....	375
WB-WS-18-010.....	139	WZ-B0-K24-02.....	327	ZM-CHC09ZE.....	26	ZZ-SZ-407-01.....	377
WB-WS-18-020.....	139	WZ-B0-K24-03.....	327	ZM-CNHC07BR2.....	13	ZZ-SZ-408-01.....	376
WB-WS-18-030.....	139	WZ-B0-K24-04.....	327	ZM-CNHC08BR2.....	12	ZZ-SZ-409-01.....	377
WB-WS-18-031.....	139	WZ-B0-K24-05.....	327	ZM-CNHC09BR2.....	12	ZZ-20-202-01.....	377
WB-WS-18-032.....	139	WZ-B0-K24-06.....	327	ZM-ECHC073DBEO.....	11	ZZ-ZN-138-01.....	372
WB-WS-18-033.....	139	WZ-B0-K24-07.....	327	ZM-ECHC07BEO.....	10	ZZ-ZN-338-01.....	374
WB-WS-18-060.....	139	WZ-B0-K24-08.....	327	ZM-ECHC07ZE.....	10		
WB-WS-24-001.....	139	WZ-C0-K24-01.....	328	ZM-ECHC083DBEO.....	11		
WB-WS-24-010.....	139	WZ-C0-K24-02.....	328	ZM-ECHC08BEO.....	9		
WB-WS-24-020.....	139	WZ-C0-K24-03.....	328	ZM-ECHC093DBEO.....	10		
WB-WS-24-030.....	139	WZ-C0-K24-04.....	328	ZM-ECHC09BEO.....	9		
WB-WS-24-031.....	139	WZ-C0-K24-05.....	328	ZM-ECHC09ZE.....	9		
WB-WS-24-032.....	139	WZ-D-892-02.....	330	ZM-HCKT30-BE.....	15		
WB-WS-24-033.....	139	WZ-D-892-05.....	330	ZM-HCKT30-ZE.....	15		
WB-WS-24-060.....	139	WZ-E-018-01.....	330	ZM-HCKT45-BE.....	15		
W-CUSTOMI-60L450.....	221	WZ-E-018-02.....	330	ZM-HCKT45-ZE.....	15		
W-CUSTOMI-60L500.....	221	WZ-E-018-05.....	330	ZM-HCKT90-BE.....	16		
W-CUSTOMI-80L450.....	222	WZ-E-018-06.....	330	ZM-HCKT90-ZE.....	16		
		WZ-K23-D1-01.....	326	ZM-HCKT155BE.....	16		
		WZ-K23-D1-02.....	326	ZM-HCKT155ZE.....	16		
				ZM-HCKT165BE.....	17		
				ZM-HCKT165ZE.....	16		
				ZM-HCKT165ZE.....	16		
				ZM-HCRALU9BE.....	32		
				ZM-INHC070BEO.....	14		
				ZM-INHC070ZE.....	14		
				ZM-INHC080BEO.....	14		
				ZM-INHC080ZE.....	14		
				ZM-INHC090BEO.....	13		
				ZM-INHC090ZE.....	13		
				ZP-BICN070BEO.....	20		

Niniejszy katalog produktów został przygotowany przez GTV Poland. Poprzez ciągłe udoskonalanie swojej oferty, zgodnie z wymogami rynkowymi i prawnymi, GTV Poland zastrzega sobie prawo do wprowadzania zmian w przedstawionym asortymencie. Prezentowana publikacja nie jest ofertą w rozumieniu Kodeksu Cywilnego. Rzeczywiste produkty mogą odbiegać od poglądowych zdjęć i rysunków zamieszczonych w publikacji. GTV Poland zastrzega sobie prawo do zmian i błędów w druku.

This product catalogue has been prepared by GTV Poland. Constantly improving its products so as to follow market and legal requirements, GTV Poland reserves the right to introduce changes in the presented product range. The present publication does not constitute an offer within the meaning of the Civil Code. The real products can differ from the example photographs and drawings in the publication. GTV Poland reserves the right to make changes and printing errors.

Данный каталог был создан компанией GTV Poland. В соответствии с действующим законодательством и требованиями рынка, компания GTV Poland оставляет за собой право вносить изменения в ассортимент предлагаемого товара. Данная публикация носит информационно-ознакомительный характер и не является коммерческим предложением в понимании права. Компания не несет ответственности за возможные цветовые расхождения, печати и неточности.